

# Basic Connector Dimensions

## Most Popular **Standard** Connectors

**Universal  
OSTW and HSTW  
"Fits All"**

### OSTW

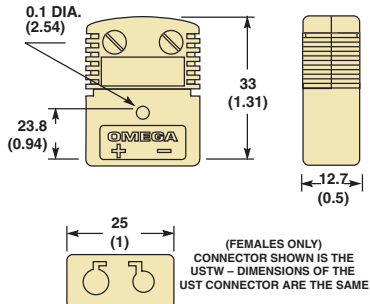

### OSTW & HSTW

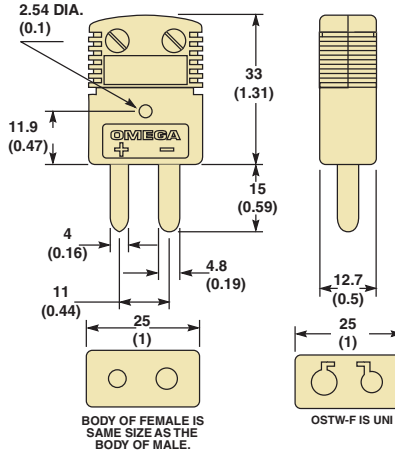

### OSTW-CC

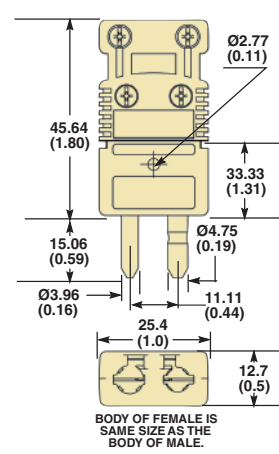

### OGP

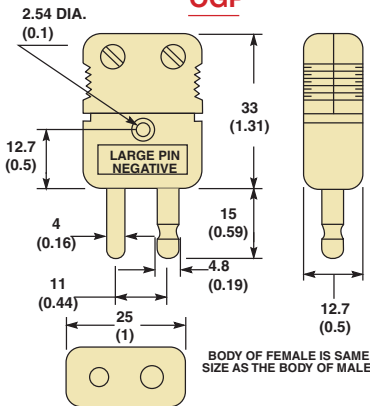

### DTC

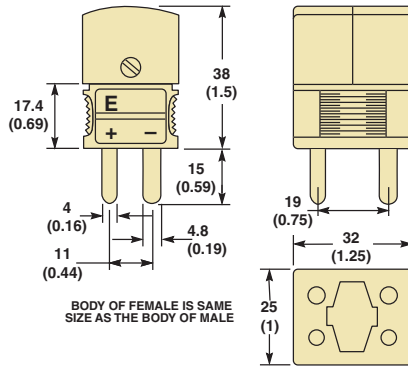

### NHX & NHXH

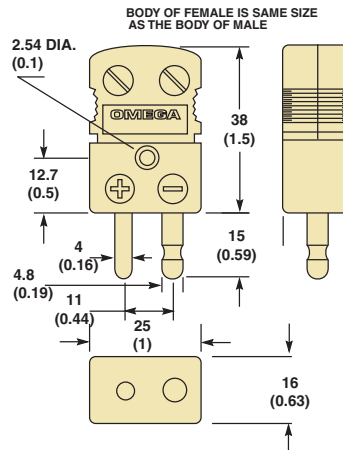

### NOX

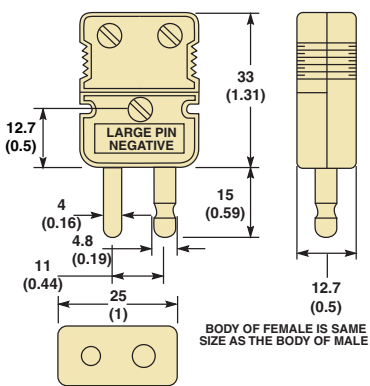

### OTP

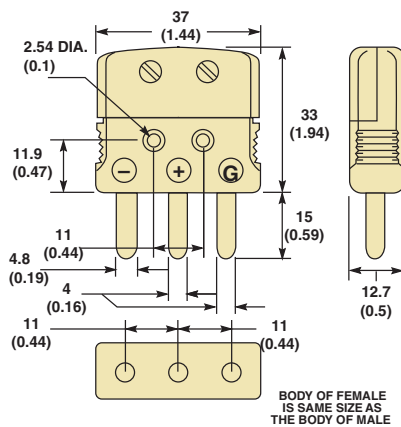

### GST (HGST)

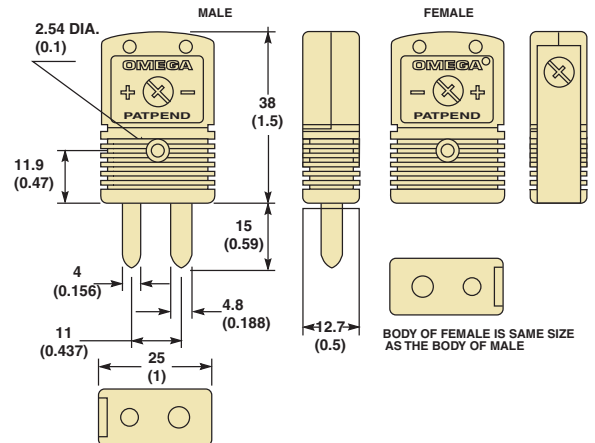

Dimensions: mm (inches)

# Basic Connector Dimensions

## Most Popular **Miniature** Connectors and Circuit Board Connectors

### HMPW, SMPW & SMP

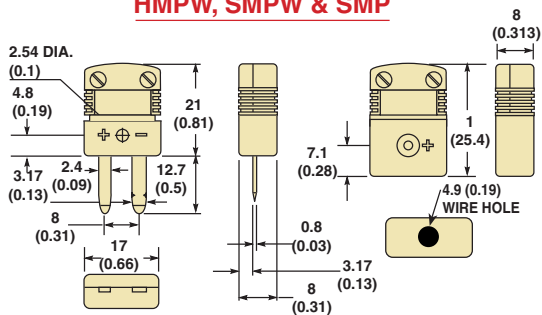

### NMP

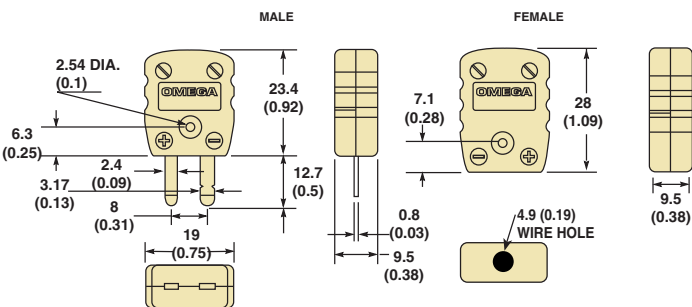

### SHX & USHX

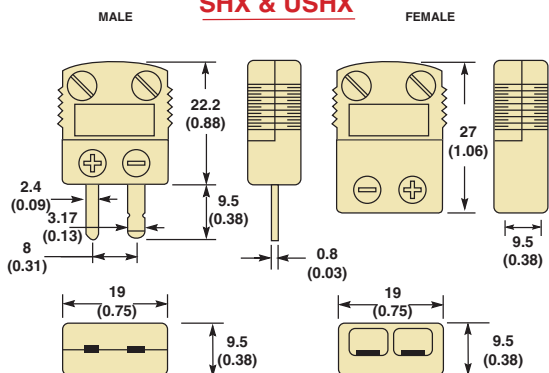

### GMP & HGMP

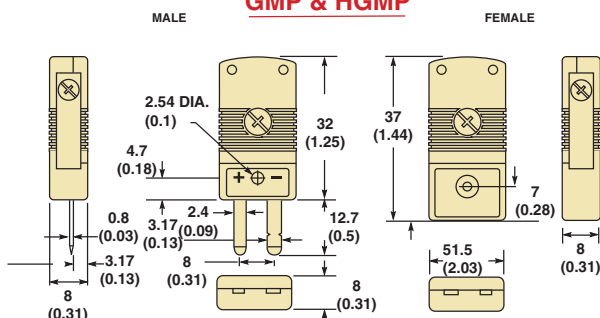

### MTP

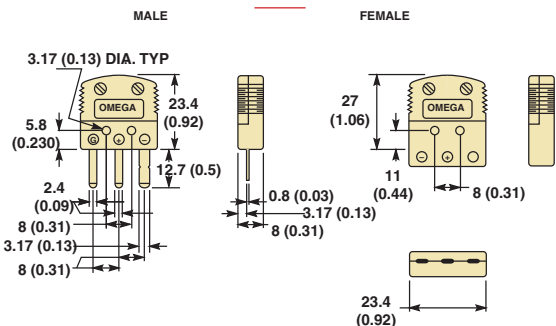

### PCC-OST

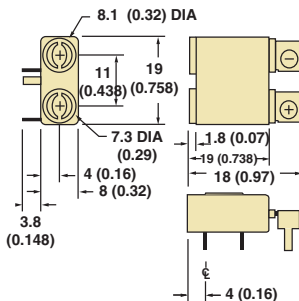

### PCC-SMP

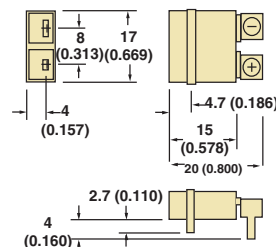

### PCC-SMP-V

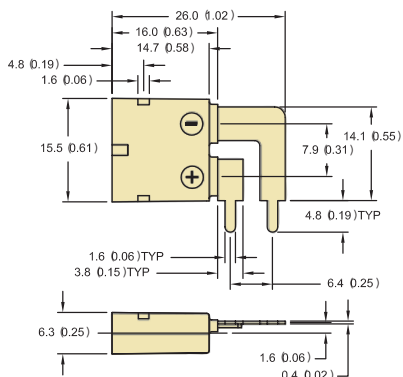

### SMPW-CC

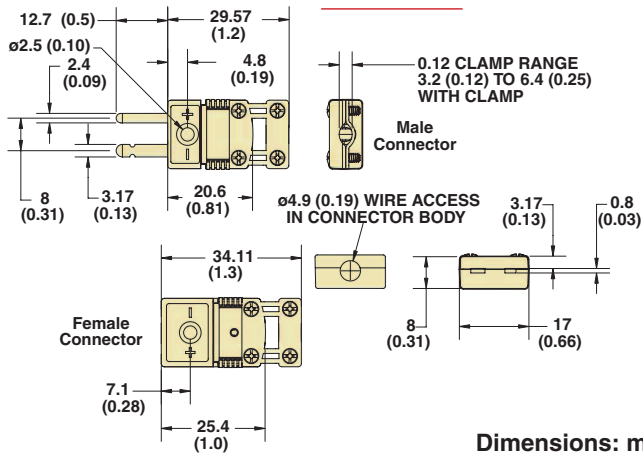

Dimensions: mm (inches)

# Basic Connector Dimensions

## Most Popular Transition and Panel Connectors

**TAS-U-5**

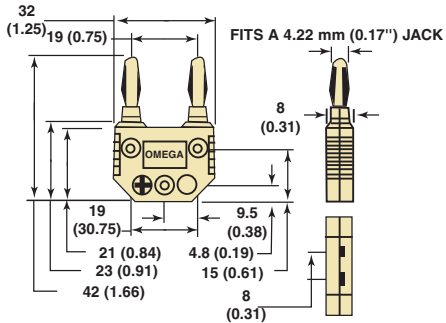

**TAS-( ) ( )**

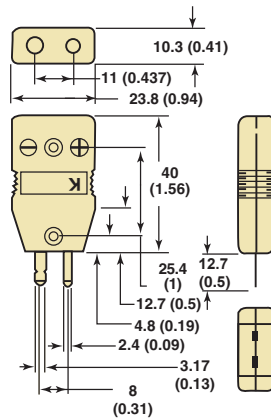

**UPJ**

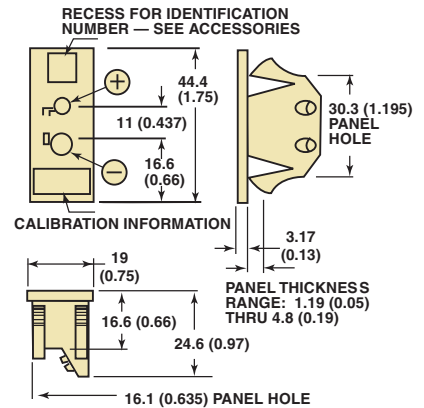

**UPF and SPJ**

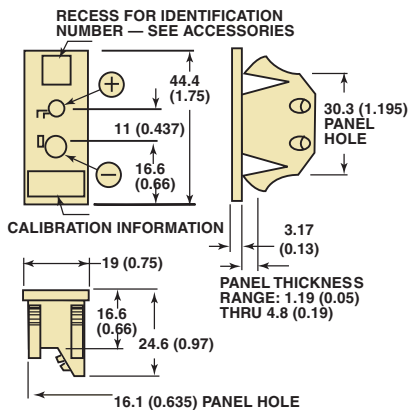

**JP**

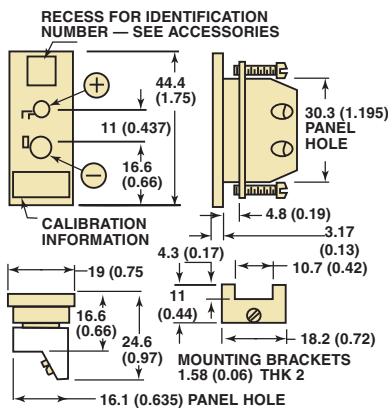

**TPJ**

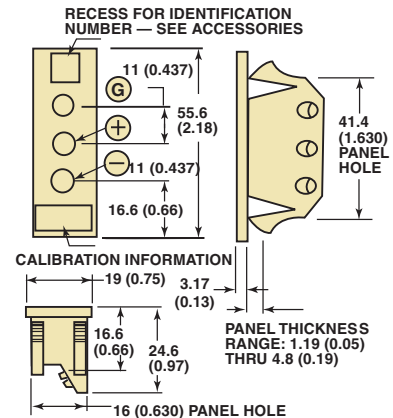

**RSJ-( ) S & R**

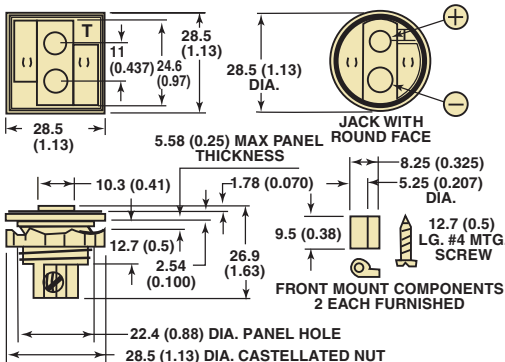

**RMJ-S RMJ-R**

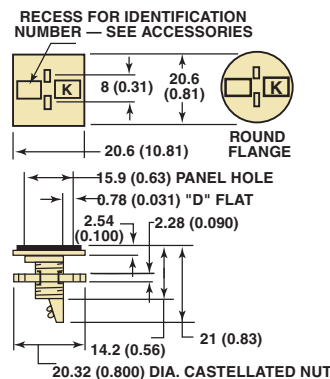

**MPJ**

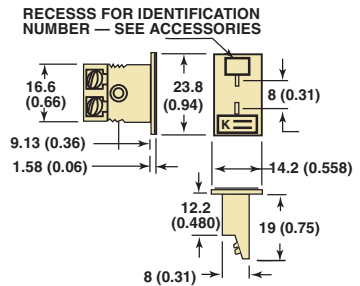

Dimensions: mm (inches)

# Basic Connector Dimensions

## Most Popular Multipin and Miscellaneous Connectors

### MTC ( ) FF

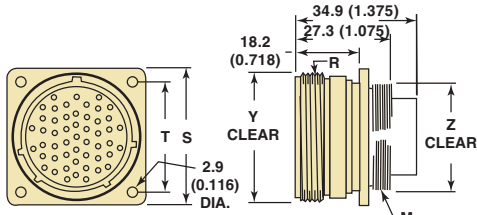

PINS	T	S	Y	Z	M THRD.	R THRD.
5	18.26 (0.72)	23.88 (0.94)	19.05 (0.75)	14.48 (0.57)	0.562-24 UNEF	0.687-24
12	20.62 (0.81)	26.16 (1.03)	23.11 (0.91)	19.30 (0.76)	0.750-20 UNEF	0.875-20
24	24.61 (0.97)	31.75 (1.25)	28.19 (1.11)	24.13 (0.95)	0.937-20 UNEF	1.062-18
41	29.36 (1.16)	36.58 (1.44)	33.78 (1.33)	30.48 (1.20)	1.187-18 UNEF	1.312-18
55	31.75 (1.25)	39.62 (1.56)	36.83 (1.45)	33.53 (1.32)	1.312-18 UNEF	1.437-18

### FC & MC

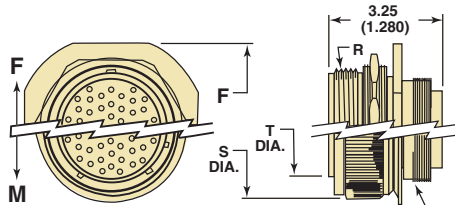

PINS	S	T	F	M THRD	R THRD.
5	21.08 (0.83)	13.46 (0.53)	27.67 (1.09)	0.562-24	0.687-24
12	25.15 (0.99)	17.78 (0.70)	32.77 (1.29)	0.750-20	0.875-20
24	30.23 (1.19)	22.61 (0.89)	38.61 (1.52)	0.937-20	1.062-18
41	36.07 (1.42)	28.45 (1.12)	45.97 (1.81)	1.187-18	1.312-18
55	39.37 (1.55)	31.75 (1.25)	49.53 (1.95)	1.312-18	1.437-18

### MTC

### MSP

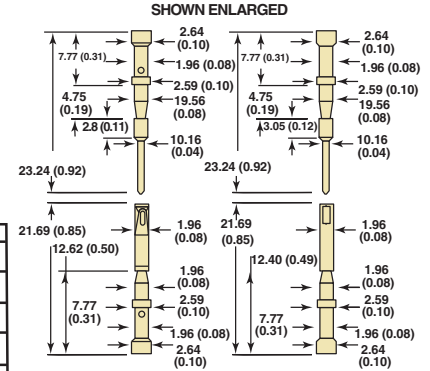

### SMTC

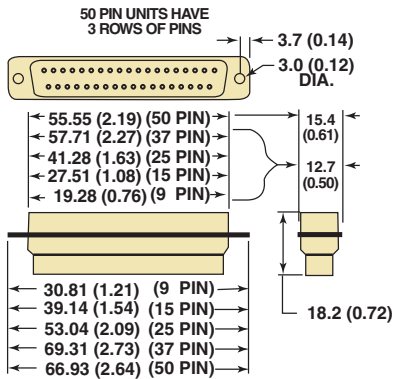

### SMTC PINS

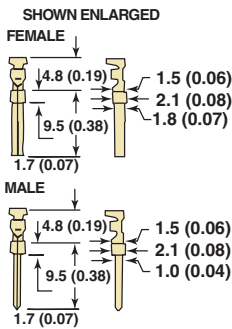

### TA ( ) F

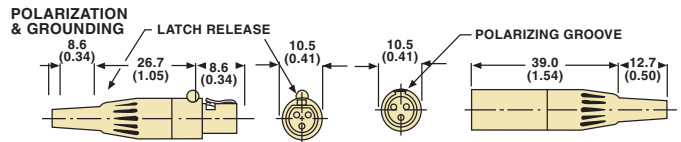

### TA ( ) M

### TA ( ) FL

### TA ( ) ML



ALL DIMENSIONS SAME AS SHOWN ABOVE

### BS

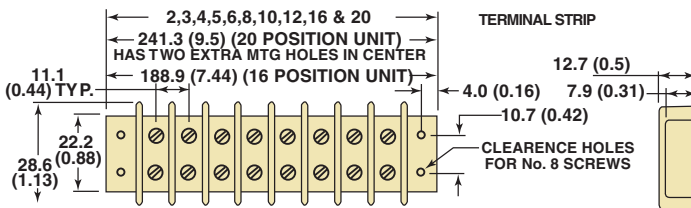

### TL

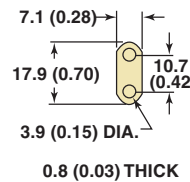

### SL

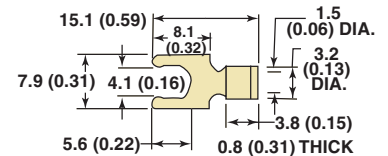

### TY

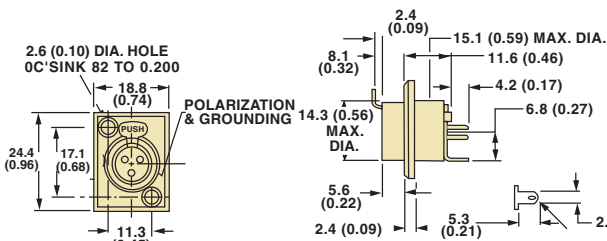

### TB

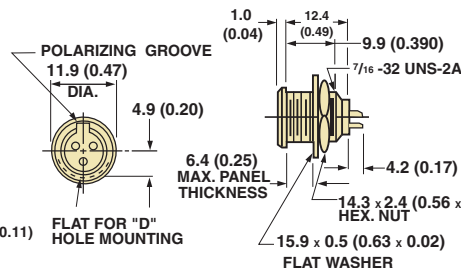

### CH6 ( )

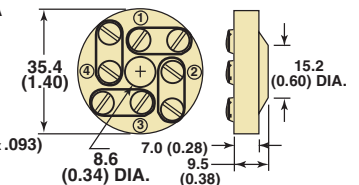

Dimensions: mm (inches)



#### UNITED STATES

[www.omega.com](http://www.omega.com)  
1-800-TC-OMEGA  
Stamford, CT.

#### CANADA

[www.omega.ca](http://www.omega.ca)  
Laval(Quebec)  
1-800-TC-OMEGA

#### GERMANY

[www.omega.de](http://www.omega.de)  
Deckenpfronn, Germany  
0800-8266342

#### UNITED KINGDOM

[www.omega.co.uk](http://www.omega.co.uk)  
Manchester, England  
0800-488-488

#### FRANCE

[www.omega.fr](http://www.omega.fr)  
Guyancourt, France  
088-466-342

#### CZECH REPUBLIC

[www.omegaeng.cz](http://www.omegaeng.cz)  
Karviná, Czech Republic  
596-311-899

#### BENELUX

[www.omega.nl](http://www.omega.nl)  
Amstelveen, NL  
0800-099-33-44



## More than 100,000 Products Available!

### • Temperature

Calibrators, Connectors, General Test and Measurement Instruments, Glass Bulb Thermometers, Handheld Instruments for Temperature Measurement, Ice Point References, Indicating Labels, Crayons, Cements and Lacquers, Infrared Temperature Measurement Instruments, Recorders Relative Humidity Measurement Instruments, RTD Probes, Elements and Assemblies, Temperature & Process Meters, Timers and Counters, Temperature and Process Controllers and Power Switching Devices, Thermistor Elements, Probes and Assemblies, Thermocouples Thermowells and Head and Well Assemblies, Transmitters, Wire

### • Flow and Level

Air Velocity Indicators, Doppler Flowmeters, Level Measurement, Magnetic Flowmeters, Mass Flowmeters, Pitot Tubes, Pumps, Rotameters, Turbine and Paddle Wheel Flowmeters, Ultrasonic Flowmeters, Valves, Variable Area Flowmeters, Vortex Shedding Flowmeters

### • pH and Conductivity

Conductivity Instrumentation, Dissolved Oxygen Instrumentation, Environmental Instrumentation, pH Electrodes and Instruments, Water and Soil Analysis Instrumentation

### • Data Acquisition

Auto-Dialers and Alarm Monitoring Systems, Communication Products and Converters, Data Acquisition and Analysis Software, Data Loggers Plug-in Cards, Signal Conditioners, USB, RS232, RS485 and Parallel Port Data Acquisition Systems, Wireless Transmitters and Receivers

### • Pressure, Strain and Force

Displacement Transducers, Dynamic Measurement Force Sensors, Instrumentation for Pressure and Strain Measurements, Load Cells, Pressure Gauges, Pressure Reference Section, Pressure Switches, Pressure Transducers, Proximity Transducers, Regulators, Strain Gages, Torque Transducers, Valves

### • Heaters

Band Heaters, Cartridge Heaters, Circulation Heaters, Comfort Heaters, Controllers, Meters and Switching Devices, Flexible Heaters, General Test and Measurement Instruments, Heater Hook-up Wire, Heating Cable Systems, Immersion Heaters, Process Air and Duct, Heaters, Radiant Heaters, Strip Heaters, Tubular Heaters