

# TRANSACTIONS

IN MEASUREMENT AND CONTROL

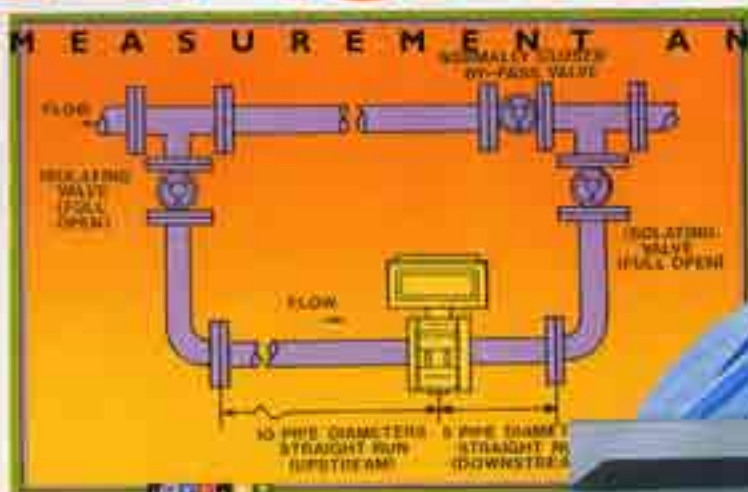

VOLUME 4  
FLOW & LEVEL MEASUREMENT

[www.omega.com](http://www.omega.com) • e-mail: [flow@omega.com](mailto:flow@omega.com)

[omega.com](http://omega.com)

OMEGA

[OMEGA.COM](http://OMEGA.COM)

# TRANSACTIONS

I N M E A S U R E M E N T A N D C O N T R O L

## Flow & Level Measurement

A Technical Reference Series Brought to You by OMEGA

**VOLUME**

4

**TABLE OF CONTENTS**

# TRANSACTIONS

IN MEASUREMENT AND CONTROL

**VOLUME 4—FLOW & LEVEL MEASUREMENT**

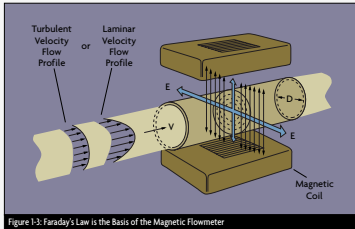
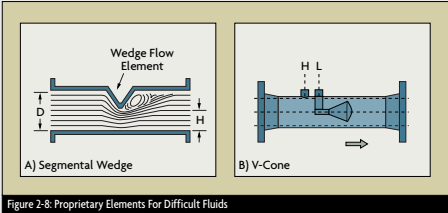
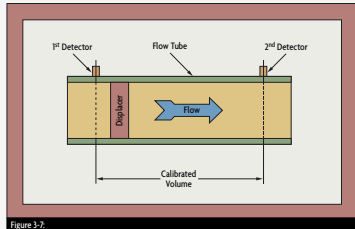
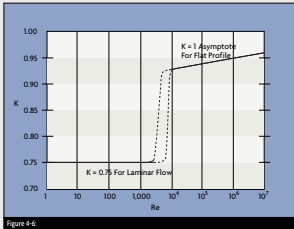
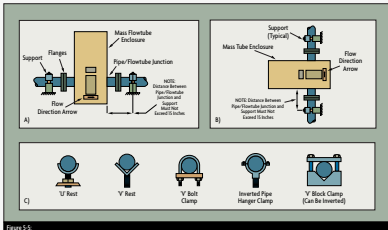
Section	Topics Covered	Page
1 A Flow Measurement Orientation	<ul style="list-style-type: none"> <li>The Flow Pioneers</li> <li>Flow Sensor Selection</li> <li>Accuracy vs. Repeatability</li> </ul>  <p>Figure 3-3: Faraday's Law is the Basis of the Magnetic Flowmeter</p>	08
2 Differential Pressure Flowmeters	<ul style="list-style-type: none"> <li>Primary Element Options</li> <li>Pitot Tubes</li> <li>Variable Area Flowmeters</li> </ul>  <p>Figure 2-8: Proprietary Elements for Difficult Fluids</p>	16
3 Mechanical Flowmeters	<ul style="list-style-type: none"> <li>Positive Displacement Flowmeters</li> <li>Turbine Flowmeters</li> <li>Other Rotary Flowmeters</li> </ul>  <p>Figure 3-7:</p>	34
4 Electronic Flowmeters	<ul style="list-style-type: none"> <li>Magnetic Flowmeters</li> <li>Vortex Flowmeters</li> <li>Ultrasonic Flowmeters</li> </ul>  <p>Figure 4-4:</p>	46
5 Mass Flowmeters	<ul style="list-style-type: none"> <li>Coriolis Mass Flowmeters</li> <li>Thermal Mass Flowmeters</li> <li>Hot-Wire Anemometers</li> </ul>  <p>Figure 5-5:</p>	58

## REFERENCE SECTIONS

Editorial	06	106	Information Resources
About OMEGA	07	110	Glossary

## VOLUME 4—FLOW & LEVEL MEASUREMENT

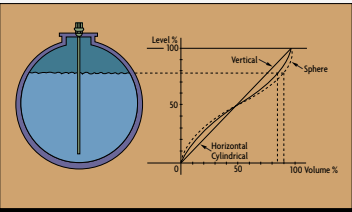
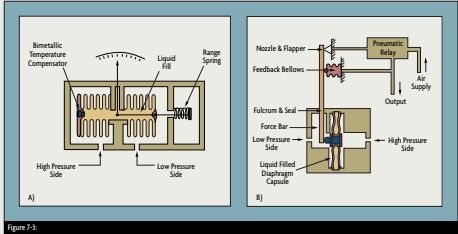
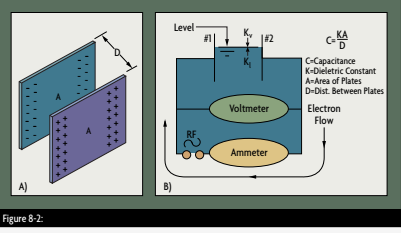
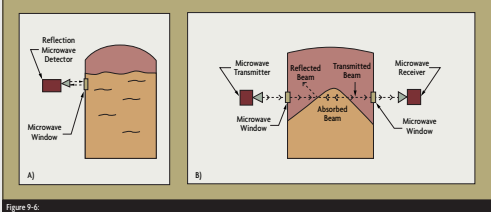
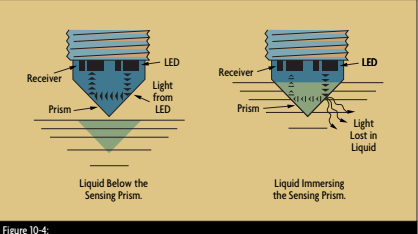
Section	Topics Covered	Page
6 A Level Measurement Orientation	<ul style="list-style-type: none"> <li>Level Sensor Selection</li> <li>Boiling &amp; Cryogenic Fluids</li> <li>Sludge, Foam, &amp; Molten Metals</li> </ul>  <p style="text-align: center; font-size: small;">Figure 6-2.</p>	72
7 Pressure/Density Level Instrumentation	<ul style="list-style-type: none"> <li>Dry &amp; Wet Leg Designs</li> <li>Bubbler Tubes</li> <li>Floats &amp; Displacers</li> </ul>  <p style="text-align: center; font-size: small;">Figure 7-3.</p>	76
8 RF/Capacitance Level Instrumentation	<ul style="list-style-type: none"> <li>Theory of Operation</li> <li>Probe Designs</li> <li>Installation Considerations</li> </ul>  <p style="text-align: center; font-size: small;">Figure 8-2.</p>	87
9 Radiation-Based Level Instrumentation	<ul style="list-style-type: none"> <li>Radar &amp; Microwave</li> <li>Ultrasonic Level Gages</li> <li>Nuclear Level Gages</li> </ul>  <p style="text-align: center; font-size: small;">Figure 9-6.</p>	93
10 Specialty Level Switches	<ul style="list-style-type: none"> <li>Thermal Switches</li> <li>Vibrating Switches</li> <li>Optical Switches</li> </ul>  <p style="text-align: center; font-size: small;">Figure 10-4.</p>	102

- 1 The Flow Pioneers
- 2 Flow Sensor Selection
- 3 Accuracy vs. Repeatability

# A Flow Measurement Orientation

Our interest in the measurement of air and water flow is timeless. Knowledge of the direction and velocity of air flow was essential information for all ancient navigators, and the ability to measure water flow was necessary for the fair distribution of water through the aqueducts of such early communities as

dynamics, pneumatics, aerodynamics) is based on the works of the ancient Greek scientists Aristotle and Archimedes. In the Aristotelian view, motion involves a medium that rushes in behind a body to prevent a vacuum. In the sixth century A.D., John Philoponos suggested that a body in motion acquired a property called impetus, and that the body came to

that Newton's third law of motion applies not only to stationary bodies, but also to objects in motion.

## The Flow Pioneers

A major milestone in the understanding of flow was reached in 1783 when the Swiss physicist Daniel Bernoulli published his *Hydrodynamica*. In it, he introduced the concept of the conservation of energy for fluid flows. Bernoulli determined that an increase in the velocity of a flowing fluid increases its kinetic energy while decreasing its static energy. It is for this reason that a flow restriction causes an increase in the flowing velocity and also causes a drop in the static pressure of the flowing fluid.

The permanent pressure loss through a flowmeter is expressed either as a percentage of the total pressure drop or in units of velocity heads, calculated as  $V^2/2g$ , where  $V$  is the flowing velocity and  $g$  is the gravitational acceleration (32.2 feet/second<sup>2</sup> or 9.8 meters/second<sup>2</sup> at 60° latitude). For example, if the velocity of a flowing fluid is 10 ft/s, the velocity head is  $100/64.4 = 1.55$  ft. If the fluid is water, the velocity head corresponds to 1.55 ft of water (or 0.67 psi). If the fluid is air, then the velocity head corresponds to the weight of a 1.55-ft column of air.

The permanent pressure loss through various flow elements can be expressed as a percentage of the total pressure drop (Figure 1-1), or it can be expressed in terms of velocity heads. The permanent pressure loss through an orifice is four velocity heads; through a vortex shedding sensor, it is two; through positive

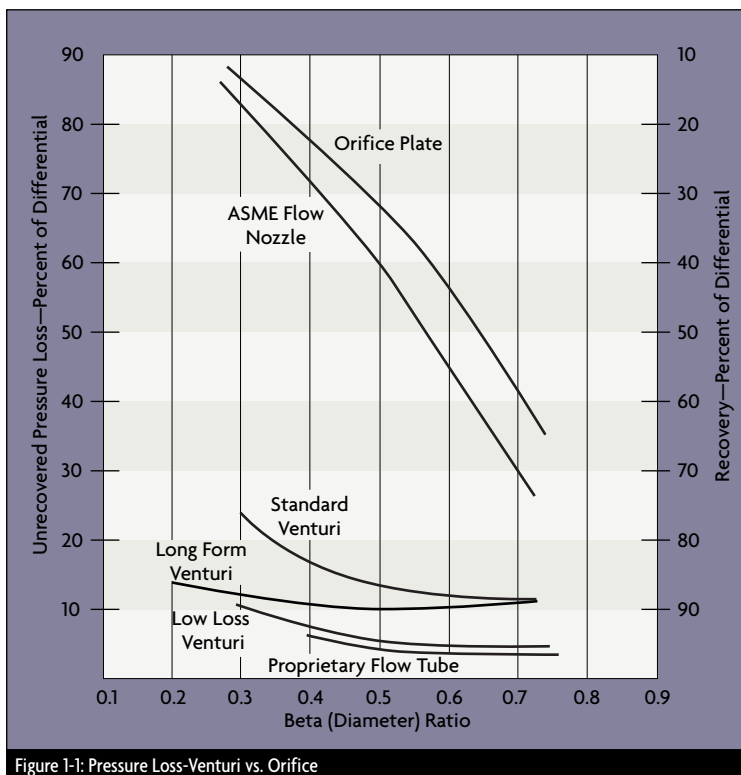

Figure 1-1: Pressure Loss-Venturi vs. Orifice

the Sumerian cities of Ur, Kish, and Mari near the Tigris and Euphrates Rivers around 5,000 B.C. Even today, the distribution of water among the rice patties of Bali is the sacred duty of authorities designated the "Water Priests."

Our understanding of the behavior of liquids and gases (including hydro-

rest when its impetus died out.

In 1687, the English mathematician Sir Isaac Newton discovered the law of universal gravitation. The operation of angular momentum-type mass flowmeters is based directly on Newton's second law of angular motion. In 1742, the French mathematician Rond d'Alembert proved



displacement and turbine meters, about one; and, through flow venturis, less than 0.5 heads. Therefore, if an orifice plate (Figure 1-2) with a beta ratio

where  $C$  is the constant for units conversion.

Over the past several years, the performance of magnetic flowmeters

single, dimensionless ratio to describe the velocity profile of flowing fluids:

$$Re = DV\rho/\mu$$

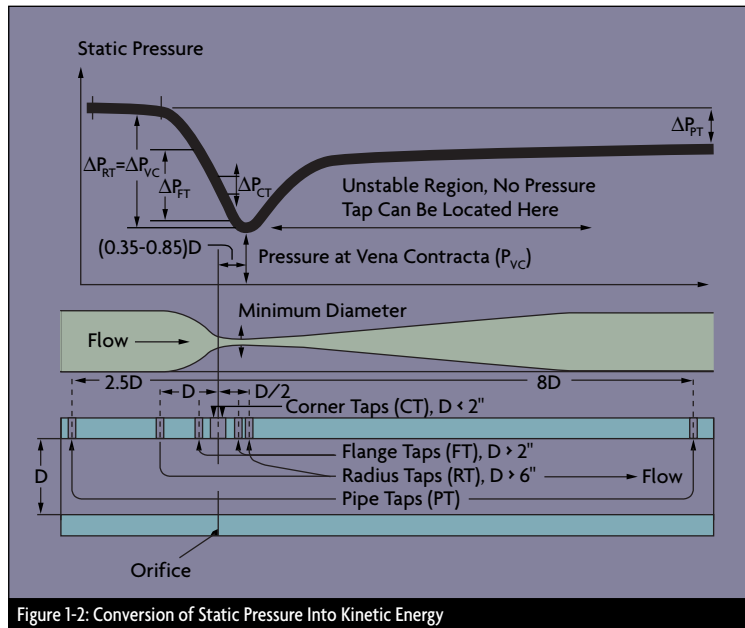

Figure 1-2: Conversion of Static Pressure Into Kinetic Energy

of 0.3 (diameter of the orifice to that of the pipe) has an unrecovered pressure loss of 100 in H<sub>2</sub>O, a venturi flow tube could reduce that pressure loss to about 12 in H<sub>2</sub>O for the same measurement.

In 1831, the English scientist Michael Faraday discovered the dynamo when he noted that, if a copper disk is rotated between the poles of a permanent magnet, electric current is generated. Faraday's law of electromagnetic induction is the basis for the operation of the magnetic flowmeter. As shown in Figure 1-3, when a liquid conductor moves in a pipe having a diameter ( $D$ ) and travels with an average velocity ( $V$ ) through a magnetic field of  $B$  intensity, it will induce a voltage ( $E$ ) according to the relationship:

$$E = BVDC$$

has improved significantly. Among the advances are probe and ceramic insert designs and the use of pulsed magnetic fields (Figure 1-4), but the basic operating principle of Faraday's law of electric induction has not changed.

In 1883, the British mechanical engineer Osborne Reynolds proposed a

Where  $D$  is the pipe diameter,  $V$  is the fluid velocity,  $\rho$  is the fluid density, and  $\mu$  is the fluid viscosity.

He noted that, at low Reynolds numbers (below 2,000) (Figure 1-5), flow is dominated by viscous forces and the velocity profile is (elongated) parabolic. At high Reynolds numbers (above 20,000), the flow is dominated by inertial forces, resulting in a more uniform axial velocity across the flowing stream and a flat velocity profile.

Until 1970 or so, it was believed that the transition between laminar and turbulent flows is gradual, but increased understanding of turbulence through supercomputer modeling has shown that the onset of turbulence is abrupt.

When flow is turbulent, the pressure drop through a restriction is proportional to the square of the flowrate. Therefore, flow can be measured by taking the square root of a differential pressure cell output. When the flow is laminar, a linear relationship exists between flow and pressure drop. Laminar flowmeters

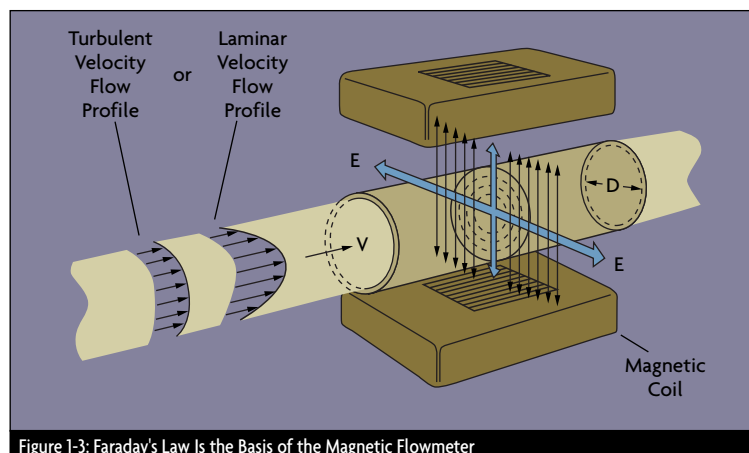

Figure 1-3: Faraday's Law Is the Basis of the Magnetic Flowmeter

are used at very low flowrates (capillary flowmeters) or when the viscosity of the process fluid is high.

In the case of some flowmeter technologies, more than a century elapsed between the discovery of a

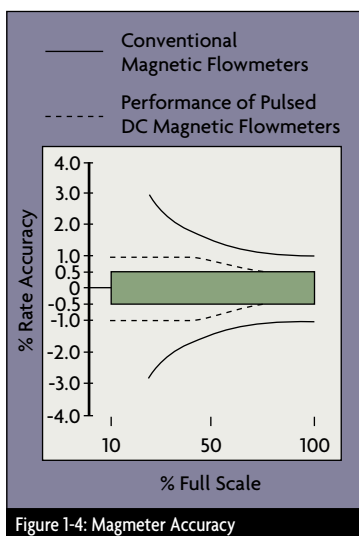

Figure 1-4: Magmeter Accuracy

scientific principle and its use in building a flowmeter. This is the case with both the Doppler ultrasonic and the Coriolis meter.

In 1842, the Austrian physicist Christian Doppler discovered that, if a sound source is approaching a receiver (such as a train moving toward a stationary listener), the frequency of the sound will appear higher. If the source and the recipient are moving away from each other, the pitch will drop (the wavelength of the sound will appear to decrease). Yet it was more than a century later that the first ultrasonic Doppler flowmeter came on the market. It projected a 0.5-MHz beam into a flowing stream containing reflectors such as bubbles or particles. The shift in the reflected frequency was a function of the average traveling velocity of the reflectors. This speed, in turn, could be used to calculate a flowrate.

The history of the Coriolis

flowmeter is similar. The French civil engineer Gaspard Coriolis discovered in 1843 that the wind, the ocean currents, and even airborne artillery shells will all drift sideways because of the earth's rotation. In the northern hemisphere, the deflection is to the right of the motion; in the southern hemisphere, it is to the left. Similarly, a body traveling toward either pole will veer eastward, because it retains the greater eastward rotational speed of the lower altitudes as it passes over the more slowly rotating earth surface near the poles. Again, it was the slow evolution of sensors and electronics that delayed creation of the first commercial Coriolis mass flowmeter until the 1970's.

It was the Hungarian-American aeronautical engineer Theodore von Karman who, as a child growing up in Transylvania (now Romania), noticed that stationary rocks caused vortices in flowing water, and that the distances between these traveling vortices are constant, no matter how fast or slow the water runs. Later in life, he also observed that, when a flag flutters in the wind, the wavelength of the flutter is independent of wind velocity and depends

vortex flowmeter, which determines flow velocity by counting the number of vortices passing a sensor. Von Karman published his findings in 1954, and because by that time the sensors and electronics required to count vortices were already in existence, the first edition of the *Instrument Engineers' Handbook* in 1968 was able to report the availability of the first swirlmeter.

The computer has opened new frontiers in all fields of engineering, and flow measurement is no exception. It was only as long ago as 1954 that another Hungarian-American mathematician, John Von Neumann, built Uniac—and even more recently that yet another Hungarian-American, Andy Grove of Intel, developed the integrated circuit. Yet these events are already changing the field of flowmetering. Intelligent differential pressure cells, for example, can automatically switch their range between two calibrated spans (one for 1-10%, the other for 10-100% of D/P), extending orifice accuracy to within 1% over a 10:1 flow range. Furthermore, it is possible to include in this accuracy statement not only hysteresis, rangeability, and linearity



Flow measurement options run the gamut from simple, economical paddle wheels (shown) to sophisticated high-accuracy devices.

solely on the diameter of the flag pole. This is the theory behind the

effects, but also drift, temperature, humidity, vibration, over-range, and

power supply variation effects.

With the development of super-chips, the design of the universal flowmeter also has become feasible. It is now possible to replace dye-tagging or chemical-tracing meters (which measured flow velocity by dividing the distance between two points by the transit time of the trace), with traceless cross-correlation flowmeters (Figure 1-6). This is an elegant flowmeter because it requires no physical change in the process—not even penetration of the pipe. The measurement is based on memorizing the noise pattern in any externally detectable process variable, and, as the fluid travels from point A to point B, noting its transit time.

### Flow Sensor Selection

The purpose of this section is to provide information to assist the reader in making an informed selection of flowmeter for a particular application. Selection and orientation tables are used to quickly focus on the most likely candidates for measurement. Tables 1-1 and 1-11 have been prepared to make available a large amount of information for this selection process.

At this point, one should consider such intangible factors as familiarity of plant personnel, their experience with calibration and maintenance, spare parts availability, mean time between failure history, etc., at the particular plant site. It is also recommended that the cost of the installation be computed only after taking these steps. One of the most common flow measurement mistakes is the reversal of this sequence: instead of selecting a sensor which will perform properly, an attempt is made to justify the use of a device because it is less expensive.

Those “inexpensive” purchases can be the most costly installations.

The basis of good flowmeter selection is a clear understanding of the requirements of the particular application. Therefore, time should be invested in fully evaluating the nature of the process fluid and of the overall installation. The development of specifications that state the appli-

data be filled in for each application:

- Fluid and flow characteristics: In this section of the table, the name of the fluid is given and its pressure, temperature, allowable pressure drop, density (or specific gravity), conductivity, viscosity (Newtonian or not?) and vapor pressure at maximum operating temperature are listed, together with an indica-

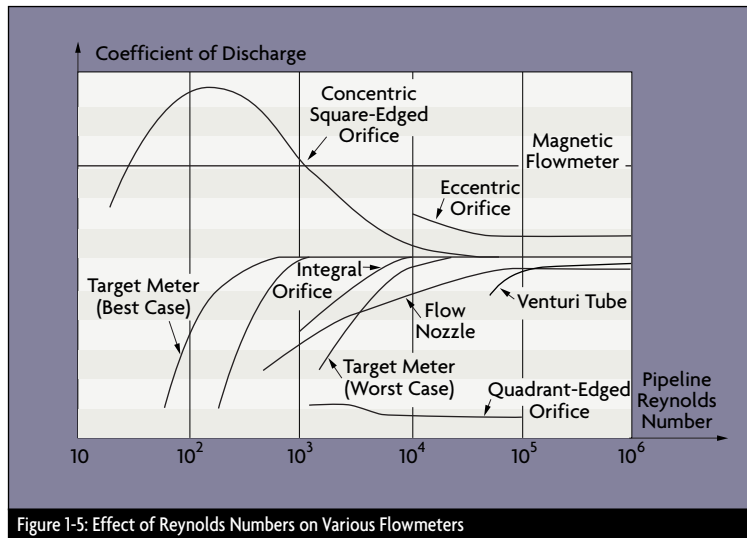

Figure 1-5: Effect of Reynolds Numbers on Various Flowmeters

cation requirements should be a systematic, step-by-step process.

The first step in the flow sensor selection process is to determine if the flowrate information should be continuous or totalized, and whether this information is needed locally or remotely. If remotely, should the transmission be analog, digital, or shared? And, if shared, what is the required (minimum) data-update frequency? Once these questions are answered, an evaluation of the properties and flow characteristics of the process fluid, and of the piping that will accommodate the flowmeter, should take place (Table 1-1). In order to approach this task in a systematic manner, forms have been developed, requiring that the following types of

tion of how these properties might vary or interact. In addition, all safety or toxicity information should be provided, together with detailed data on the fluid’s composition, presence of bubbles, solids (abrasive or soft, size of particles, fibers), tendency to coat, and light transmission qualities (opaque, translucent or transparent?).

- Expected minimum and maximum pressure and temperature values should be given in addition to the normal operating values. Whether flow can reverse, whether it does not always fill the pipe, whether slug flow can develop (air-solids-liquid), whether aeration or pulsation is likely, whether sudden temperature changes can occur, or whether



special precautions are needed during cleaning and maintenance, these facts, too, should be stated.

- Concerning the piping and the area where the flowmeter is to be located, the following information

with sanitary or clean-in-place (CIP) regulations.

The next step is to determine the required meter range by identifying minimum and maximum flows (mass or volumetric) that will be measured.

sold or purchased on the basis of a meter reading, absolute accuracy is critical. In other applications, repeatability may be more important than absolute accuracy. Therefore, it is advisable to establish separately the accuracy and repeatability requirements of each application and to state both in the specifications.

When a flowmeter's accuracy is stated in % CS or % FS units, its absolute error will rise as the measured flow rate drops. If meter error is stated in % AR, the error in absolute terms stays the same at high or low flows. Because full scale (FS) is always a larger quantity than the calibrated span (CS), a sensor with a % FS performance will always have a larger error than one with the same % CS specification. Therefore, in order to compare all bids fairly, it is advisable to convert all quoted error statements into the same % AR units.

It is also recommended that the user compare installations on the basis of the total error of the loop. For example, the inaccuracy of an orifice plate is stated in % AR, while the error of the associated d/p cell is in % CS or % FS. Similarly, the inaccuracy of a Coriolis meter is the sum of two errors, one given in % AR, the other as a % FS value. Total inaccuracy is calculated by taking the root of the sum of the squares of the component inaccuracies at the desired flow rates.

In well-prepared flowmeter specifications, all accuracy statements are converted into uniform % AR units and these % AR requirements are specified separately for minimum, normal, and maximum flows. All flowmeter specifications and bids should clearly state both the accuracy and the repeatability of the meter at minimum, normal, and maximum flows.

Table 1 provides data on the range

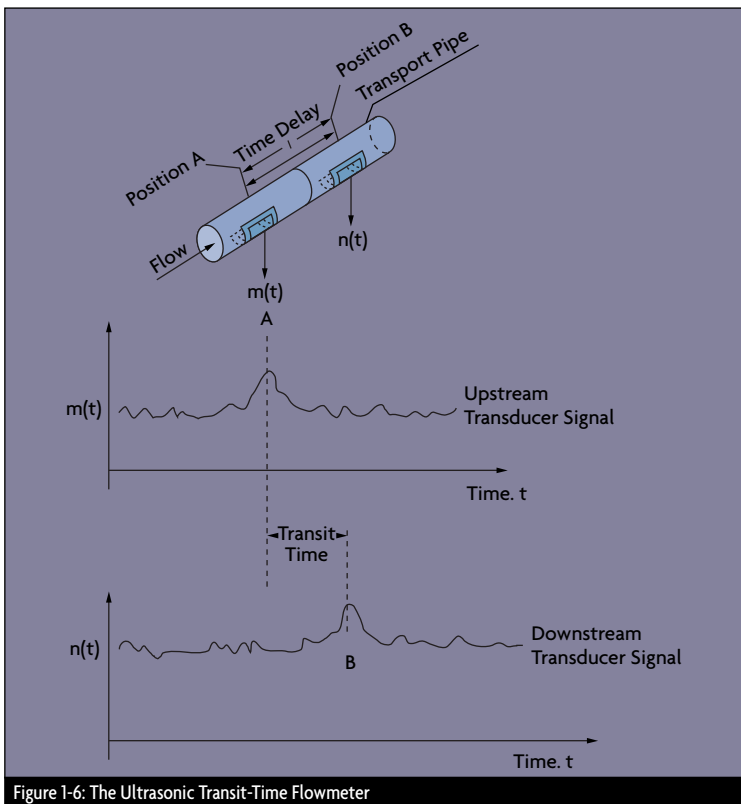

Figure 1-6: The Ultrasonic Transit-Time Flowmeter

should be specified: For the piping, its direction (avoid downward flow in liquid applications), size, material, schedule, flange-pressure rating, accessibility, up or downstream turns, valves, regulators, and available straight-pipe run lengths.

- In connection with the area, the specifying engineer must know if vibration or magnetic fields are present or possible, if electric or pneumatic power is available, if the area is classified for explosion hazards, or if there are other special requirements such as compliance

After that, the required flow measurement accuracy is determined. Typically accuracy is specified in percentage of actual reading (AR), in percentage of calibrated span (CS), or in percentage of full scale (FS) units. The accuracy requirements should be separately stated at minimum, normal, and maximum flowrates. Unless you know these requirements, your meter's performance may not be acceptable over its full range.

### Accuracy vs. Repeatability

In applications where products are

of Reynolds numbers ( $Re$  or  $R_D$ ) within which the various flowmeter designs can operate. In selecting the right flowmeter, one of the first steps is to determine both the minimum and the maximum Reynolds numbers for the application. Maximum  $R_D$  is obtained by making the calculation

when flow and density are at their maximum and viscosity at its minimum. Conversely, the minimum  $R_D$  is obtained by using minimum flow and density and maximum viscosity.

If acceptable metering performance can be obtained from two different flowmeter categories and one has

no moving parts, select the one without moving parts. Moving parts are a potential source of problems, not only for the obvious reasons of wear, lubrication, and sensitivity to coating, but also because moving parts require clearance spaces that sometimes introduce "slippage" into

Table 1: Flowmeter Evaluation Table

FLOWMETER	PIPE SIZE, in. (mm)	GASES (VAPORS)				LIQUIDS										TYPICAL Accuracy, uncalibrated (Including transmitter)	TYPICAL Reynolds number † or viscosity	TEMPERATURE °F (°C)	PRESSURE psig (kPa)				
		STEAM CLEAN	DIRTY HIGH	DIRTY LOW	PRESS	CLEAN HIGH	CLEAN LOW	VISCOUS DIRTY	CORROSIVE	VERY CORROSIVE	FIBROUS SLURRIES	ABRASIVE	REVERSE FLOW	PULSATING FLOW	HIGH TEMPERATURE					CRYOGENIC	SEMI-FILLED PIPES	NON-NEWTONIANS	OPEN CHANNEL
<b>SQUARE ROOT SCALE: MAXIMUM SINGLE RANGE 4:1 (Typical)**</b>																							
Orifice		✓	✓	✓	✓	✓	✓	✓	✓	✓	✓	✓	✓	✓	✓	✓	✓	✓	✓	±1-4% URV	$R_D > 10,000$	Process temperature to 1000°F (540°C); Transmitter limited to -30-250°F (-30-120°C)	To 4,000 psig (41,000 kPa)
Square-Edged	>1.5 (40)	✓	✓	✓	✓	✓	✓	✓	✓	✓	✓	✓	✓	✓	✓	✓	✓	✓	✓	±1% URV	$R_D > 10,000$		
Honed Meter Run	0.5-1.5 (12-40)	✓	✓	✓	✓	✓	✓	✓	✓	✓	✓	✓	✓	✓	✓	✓	✓	✓	✓	±2-5% URV	$R_D > 10,000$		
Integrated	<0.5 (12)	?	✓	✓	✓	✓	✓	✓	✓	✓	✓	✓	✓	✓	✓	✓	✓	✓	✓	±0.5% URV	$R_D > 500$		
Segmental Wedge	>12 (300)	✓	✓	✓	✓	✓	✓	✓	✓	✓	✓	✓	✓	✓	✓	✓	✓	✓	✓	±2-4% URV	$R_D > 10,000$		
Eccentric	>2 (50)	?	?	✓	✓	✓	✓	✓	✓	✓	✓	✓	✓	✓	✓	✓	✓	✓	✓	±2-4% URV	$R_D > 10,000$		
Segmental	>4 (100)	?	?	✓	✓	✓	✓	✓	✓	✓	✓	✓	✓	✓	✓	✓	✓	✓	✓	±0.5-1% of rate	$R_D > 10,000$		
V-Cone	0.5-72 (12-1800)	✓	✓	✓	✓	✓	✓	✓	✓	✓	✓	✓	✓	✓	✓	✓	✓	✓	✓	±0.5-5% URV	$R_D > 8,000-5,000,000$	700 (370)	≤600 (4,100)
Target***	<0.5(12)	?	✓	✓	✓	✓	✓	✓	✓	✓	✓	✓	✓	✓	✓	✓	✓	✓	✓	±0.5-2% URV	$R_D > 100$	Process temperature to 1000°F (540°C); Transmitter limited to -30-250°F (-30-120°C)	To 4,000 psig (41,000 kPa)
Venturi	>2 (50)	✓	✓	✓	✓	✓	✓	✓	✓	✓	✓	✓	✓	✓	✓	✓	✓	✓	✓	±1-2% URV	$R_D > 75,000\text{L}$ $R_D > 50,000\text{L}$		
Flow Nozzle	>2 (50)	?	?	✓	✓	✓	✓	✓	✓	✓	✓	✓	✓	✓	✓	✓	✓	✓	✓	±1.25% URV	$R_D > 12,800\text{L}$		
Low Loss Venturi	>3 (75)	✓	✓	✓	✓	✓	✓	✓	✓	✓	✓	✓	✓	✓	✓	✓	✓	✓	✓	±3-5% URV	$R_D > 100,000\text{L}$		
Pitot	>3 (75)	✓	✓	✓	✓	✓	✓	✓	✓	✓	✓	✓	✓	✓	✓	✓	✓	✓	✓	±1-2% URV	$R_D > 40,000\text{L}$		
Averaging Pitot	>1 (25)	✓	✓	SD	✓	✓	✓	✓	✓	✓	✓	✓	✓	✓	✓	✓	✓	✓	✓	±5-10% URV	$R_D > 10,000\text{L}$		
Elbow	>2 (50)	✓	✓	✓	✓	✓	✓	✓	✓	✓	✓	✓	✓	✓	✓	✓	✓	✓	✓	±1% of rate	$R_D < 500$	150 (66)	≤30 (225)
Laminar	0.25-16.6 (6-400)	?	✓	✓	✓	✓	✓	✓	✓	✓	✓	✓	✓	✓	✓	✓	✓	✓	✓				
<b>LINEAR SCALE TYPICAL RANGE 10:1 (Or better)</b>																							
Magnetic*	0.1-72 (2.5-1800)	X	X	X	X	X	✓	✓	✓	✓	✓	✓	✓	✓	✓	✓	✓	✓	✓	±0.5% of rate	$R_D > 4,500$	360 (180)	≤1,500 (10,800)
Positive Displacement																							
Gas	>12 (300)	X	✓	X	?	✓	X	X	X	X	X	X	X	X	X	X	X	X	X	±1% of rate	-	250 (120)	≤1,400 (10,000)
Liquid	>12 (300)	X	X	X	X	✓	✓	✓	✓	✓	✓	✓	✓	✓	✓	✓	✓	✓	✓	±0.5% of rate	No $R_D$ limit ≤ 8,000 cS	600 (315)	≤1,400 (10,000)
Turbine																							
Gas	0.25-24 (6-600)	SD	✓	X	✓	✓	X	X	X	X	X	X	X	SD	SD	?	?	X	X	±0.5% of rate	-	-450-500 (268-260)	≤3,000 (21,000)
Liquid	0.25-24 (6-600)	X	X	X	X	✓	X	?	X	X	X	SD	SD	SD	?	?	X	X	?	±0.5% of rate	$R_D > 5,000, \leq 15 \text{ cS}$	-450-500 (268-260)	≤3,000 (21,000)
Ultrasonic																							
Time of Flight	>0.5 (12)	X	SD	SD	SD	SD	?	?	?	✓	✓	✓	✓	✓	✓	X	?	X	?	±1% of rate to ffl5% URV	$R_D > 10,000$	-300-500 (-180-260)	Pipe rating
Doppler	>0.5 (12)	X	X	X	X	X	?	?	✓	✓	✓	✓	✓	✓	✓	X	X	?	X	±1% of rate to ffl5% URV	$R_D > 4,000$	-300-500 (-180-260)	Pipe rating
Variable-Area (Rotameter)	>3 (75)	?	✓	X	✓	✓	X	?	?	?	X	X	X	?	?	X	X	?	X	±1% of rate to ffl10% URV	No $R_D$ limit, ≤ 100 cS	Glass: 400 (200) Metal: 1,000 (540) 400 (200)	Glass: 350 (2,400) Metal: 720 (5,000) ≤1,500 (10,500)
Vortex Shedding	1.5-16 (40-400)	✓	✓	?	✓	✓	✓	✓	✓	✓	✓	✓	✓	✓	✓	✓	✓	✓	✓	±0.75-1.5% of rate	$R_D > 10,000, \leq 30 \text{ cP}$	400 (200)	≤1,500 (10,500)
Vortex Precession (Swirl)	>16 (400)	✓	✓	?	✓	✓	✓	✓	✓	✓	✓	✓	✓	✓	✓	✓	✓	✓	✓	±0.5% of rate	$R_D > 10,000, \leq 5 \text{ cP}$	536 (280)	Pipe rating
Fluidic Oscillation (Coanda)	>1.5 (40)	X	X	X	X	✓	X	X	?	X	X	X	X	?	?	X	X	X	?	±2% of rate	$R_D > 2,000, \leq 80 \text{ cS}$	350 (175)	≤720 (5,000)
Mass																							
Coriolis	0.25-6 (6-150)	?	?	?	✓	✓	✓	✓	✓	✓	✓	✓	✓	✓	✓	?	?	?	?	±0.15-10% of rate	No $R_D$ limit	-400-800 (-224-427)	≤5,700 (39,900)
Thermal Probe	>72 (1800)	X	✓	?	✓	✓	✓	✓	✓	✓	✓	✓	✓	✓	✓	X	?	?	X	±1-2% URV	No $R_D$ limit	1,500 (816)	Pipe rating
Solids Flowmeter	>24 (600)	X	X	X	X	X	SD	X	?	X	X	SD	SD	X	SD	SD	X	✓	X	±0.5% of rate to ffl4% URV	-	750 (400)	≤580 (4,000)
Correlation																							
Capacitance	>8 (200)	X	X	X	X	X	✓	✓	✓	✓	✓	✓	✓	✓	X	?	?	X	?	No data available	No data available	300 (149)	≤580 (4,000)
Ultrasonic	>0.5 (12)	X	X	X	X	X	?	✓	✓	✓	✓	✓	✓	✓	X	?	X	X	?	±6% of ??	No data available	-300-250 (-180-120)	Pipe rating

cP = centi Poise      ? = Normally applicable (worth consideration)      URV = Upper Range Value      † According to other sources, the minimum Reynolds number should be much higher  
cS = centi Stokes      ✓ = Designed for this application (generally suitable)      X = Not applicable  
SD = Some designs      \*\*\* Newer designs linearize the signal

the flow being measured. Even with well maintained and calibrated meters, this unmeasured flow varies with changes in fluid viscosity and temperature. Changes in temperature

also change the internal dimensions of the meter and require compensation.

Furthermore, if one can obtain the same performance from both a full flowmeter and a point sensor, it is

generally advisable to use the flowmeter. Because point sensors do not look at the full flow, they read accurately only if they are inserted to a depth where the flow velocity is

**Table 2: Orientation Table For Flow Sensors**

TYPE OF DESIGN	DIRECT MASS-FLOW SENSOR	DIFFERENTIAL PRESSURE-FLOW SENSOR	VOLUME DISPLACEMENT-FLOW SENSOR	VELOCITY-FLOW SENSOR	EXPECTED ERROR FROM VISCOSITY CHANGE	TRANSMITTER AVAILABLE	LINEAR OUTPUT	RANGEABILITY	PRESSURE LOSS THRU SENSOR	APPROX. STRAIGHT PIPE-RUN REQUIREMENT <sup>(6)</sup> (UPSTREAM DIAM./DOWNSTREAM DIAM.)	FLOW RANGE <sup>(3)</sup>				
											cc/min	Sm <sup>3</sup> /hr or Am <sup>3</sup> /hr	gpm	Solids Flow Units	Gas Flow Units
Orifice (plate or integral cell)	✓				H	✓	SR	3:1 <sup>(2)</sup>	H	20/5	-----	-----	-----	gpm-m <sup>3</sup> /hr <sup>(3)</sup>	SCFM-Sm <sup>3</sup> /hr
Segmental Wedge	✓				M	✓	SR	3:1 <sup>(2)</sup>	A	20/5	-----	-----	-----	gpm-m <sup>3</sup> /hr	
V-Cone Flowmeter	✓				✓	SR	3:1 to 15:1 <sup>(2)</sup>	M	2/5		-----	-----	-----	gpm-m <sup>3</sup> /hr	ACFM-Sm <sup>3</sup> /hr
Target Meters	✓				A	✓	SR	15:1	M	20/5	-----	-----	-----	gpm-m <sup>3</sup> /hr	SCFM-Sm <sup>3</sup> /hr <sup>(4)</sup>
Venturi Tubes	✓				H	✓	SR	3:1 <sup>(2)</sup>	M	15/5	-----	-----	-----	gpm-m <sup>3</sup> /hr	SCFM-Sm <sup>3</sup> /hr
Flow Nozzles	✓				H	✓	SR	3:1 <sup>(2)</sup>	A	20/5	-----	-----	-----	gpm-m <sup>3</sup> /hr	SCFM-Sm <sup>3</sup> /hr
Pitot Tubes	✓				M	✓	SR	3:1 <sup>(2)</sup>	M	30/5	-----	-----	-----	gpm-m <sup>3</sup> /hr	SCFM-Sm <sup>3</sup> /hr
Elbow Taps	✓				M	✓	SR	3:1 <sup>(2)</sup>	N	25/10	-----	-----	-----	gpm-m <sup>3</sup> /hr	SCFM-Sm <sup>3</sup> /hr
Laminar Flowmeters	✓				✓	✓	✓	10:1 <sup>(2)</sup>	H	15/5	-----	-----	-----	gpm-m <sup>3</sup> /hr	SCFM-Sm <sup>3</sup> /hr
Magnetic Flowmeters		✓			N	✓	✓	30:1 <sup>(7)</sup>	N	5/3	-----	-----	-----	gpm-m <sup>3</sup> /hr	
Positive Displacement Gas Meters	✓				SD	✓	✓	10:1 to 200:1	M	N	-----	-----	-----	SCFM-Sm <sup>3</sup> /hr	
Positive Displacement Liquid Meters		✓			M	SD	✓	10:1 <sup>(7)</sup>	A	N	-----	-----	-----	gpm-m <sup>3</sup> /hr	
Turbine Flowmeters		✓	✓		H	✓	✓	10:1 <sup>(8)</sup>	A	15/5	-----	-----	-----	gpm-m <sup>3</sup> /hr	SCFM-Sm <sup>3</sup> /hr
Ultrasonic Flowmeters															
Time of Flight		✓	✓		N	✓	✓	20:1	N	20/5	-----	-----	-----	gpm-m <sup>3</sup> /hr	SCFM-Sm <sup>3</sup> /hr <sup>(3)</sup>
Doppler		✓	✓		N	✓	✓	10:1	N	20/5	-----	-----	-----	gpm-m <sup>3</sup> /hr	SCFM-Sm <sup>3</sup> /hr
Variable Area (Rotameter)					A	✓	✓	10:1	M	N	-----	-----	-----	gpm-m <sup>3</sup> /hr	SCFM-Sm <sup>3</sup> /hr
Vortex Shedding	SD		✓		A	✓	✓	10:1 <sup>(6)</sup>	A	20/5	-----	-----	-----	gpm-m <sup>3</sup> /hr	ACFM-Sm <sup>3</sup> /hr
Fluidic Oscillation (Coanda)			✓		A	✓	✓	12:1 <sup>(6)</sup>	H	20/5	-----	-----	-----	gpm-m <sup>3</sup> /hr	ACFM-Sm <sup>3</sup> /hr
Mass Flowmeters Coriolis	✓				N	✓	✓	20:1	M/H	N	-----	-----	-----	lbm-kgm/hr	SCFM-Sm <sup>3</sup> /hr
Mass Flowmeters Thermal Probe	✓		SD		N	✓	✓	20:1 <sup>(7)</sup>	M	20/5	-----	-----	-----	gpm-m <sup>3</sup> /hr	SCFM-Sm <sup>3</sup> /hr
Solids Flowmeters	SD				✓	✓	✓	5:1 to 80:1	-	5/3	-----	-----	-----	lbm-kgm/hr	
Weirs, Flumes					M	✓	SD	100:1	M	4/1	-----	-----	-----	gpm-m <sup>3</sup> /hr	<sup>(3)</sup>

----- = Non-standard Range  
 L = Limited  
 SD = Some Designs  
 H = High  
 A = Average  
 M = Minimal  
 N = None  
 SR = Square Root

<sup>(1)</sup> = The data in this column is for general guidance only.  
<sup>(2)</sup> = Inherent rangeability of primary device is substantially greater than shown. Value used reflects limitations of differential pressure sensing device when 1% of rate accuracy is desired. With multiple-range intelligent transmitters, rangeability can reach 10:1.  
<sup>(3)</sup> = Pipe size establishes the upper limit.  
<sup>(4)</sup> = Practically unlimited with probe type design.

<sup>(5)</sup> = Varies with upstream disturbance.  
<sup>(6)</sup> = Can be more with high Reynolds number services.  
<sup>(7)</sup> = Up to 100:1.  
<sup>(8)</sup> = More for gas turbine meters.  
<sup>(9)</sup> = Higher and lower flow ranges may be available. Check several manufacturers.

the average of the velocity profile across the pipe. Even if this point is carefully determined at the time of calibration, it is not likely to remain unaltered, since velocity profiles change with flowrate, viscosity, temperature, and other factors.

If all other considerations are the same, but one design offers less pressure loss, it is advisable to select that design. Part of the reason is that the pressure loss will have to be paid for in higher pump or compressor operating costs over the life of the plant. Another reason is that a pressure drop is caused by any restriction in the flow path, and wherever a pipe is restricted becomes a potential site for material build-up, plugging, or cavitation.

Before specifying a flowmeter, it is also advisable to determine whether the flow information will be more useful if presented in mass or volumetric units. When measuring the flow of compressible materials, volumetric flow is not very meaningful unless density (and sometimes also viscosity) is constant. When the velocity (volumetric flow) of incompressible liquids is measured, the presence of suspended bubbles will cause error; therefore, air and gas must be removed before the fluid reaches the meter. In other velocity sensors, pipe liners can cause problems (ultrasonic), or the meter may stop functioning if the Reynolds number is too low (in vortex shedding meters,  $Re_D > 20,000$  is required).

In view of these considerations, mass flowmeters, which are insensitive to density, pressure and viscosity variations and are not affected by changes in the Reynolds number, should be kept in mind. Also underutilized in the chemical industry are the various flumes that can measure flow in partially full pipes and can pass large floating or settleable solids. 

## References & Further Reading

- OMEGA Complete Flow and Level Measurement Handbook and Encyclopedia®, OMEGA Press, 1995.
- OMEGA Volume 29 Handbook & Encyclopedia, Purchasing Agents Edition, OMEGA Press, 1995.
- “Advanced Process Control for Two-Phase Mixtures,” David Day, Christopher Reiner and Michael Pepe, *Measurements & Control*, June, 1997.
- *Applied Fluid Flow Measurement*, N.P. Chermisinoff, Marcel Dekker, 1979.
- “Characteristics and Applications of Industrial Thermal Mass Flow Transmitters,” Jerome L. Kurz, Proceedings 47th Annual Symposium on Instrumentation for the Process Industries, ISA, 1992.
- *Developments in Thermal Flow Sensors*, Jerome L. Kurz, Ph.D., Kurz Instruments Inc., 1987.
- “Differential Flow Measurement of Meter-Conditioned Flow,” Stephen A. Ifft and Andrew J. Zacharias, *Measurements & Control*, September, 1993.
- *Dry Solids Flow Update*, Auburn International Inc.
- *Flow Measurement Engineering Handbook*, R.W. Miller, McGraw-Hill, 1983.
- *Flow Measurement for Engineers and Scientists*, N.P. Chermisinoff, Marcel Dekker, 1988.
- *Flow Measurement*, Bela Liptak, CRC Press, 1993.
- “Flowmeter Geometry Improves Measurement Accuracy,” Stephen A. Ifft, *Measurements & Control*, October, 1995.
- *Flowmeters*, F. Cascetta, P. Vigo, ISA, 1990.
- *Fluidic Flowmeter*, Bulletin 1400 MX, Moore Products Co., June, 1988.
- *Fundamentals of Flow Metering*, Technical Data Sheet 3031, Rosemount Inc., 1982.
- *Guide to Variable Area Flowmeters*, Application No.: T-022 Issue I, Brooks Instrument Co., 1986.
- *Incompressible Flow*, Donald Panton, Wiley, 1996.
- *Industrial Flow Measurement*, D.W. Spitzer, ISA, 1984.
- “Installation Effects on Venturi Tube Flowmeters,” G. Kochen, D.J.M. Smith, and H. Umbach, *Intech*, October, 1989.
- *Instrument Engineers’ Handbook*, Bela Liptak, ed., CRC Press, 1995.
- “Is a Turbine Flowmeter Right for Your Application?” Michael Hammond, *Flow Control*, April, 1998.
- “Mass Flowmeters,” *Measurements & Control*, September, 1991.
- *Microprocessor-Based 2-Wire Swirlmeter*, Bailey-Fischer & Porter Co., 1995.
- “Process Gas Mass Flow Controllers: An Overview,” J. G. Olin, *Solid State Technology*, April, 1988.
- “Target Flowmeters,” George W. Anderson, *Measurements & Control*, June, 1982.
- *Thermal Approach to Flow Measurement*, Joseph W. Harpster and Robert Curry, Intek, Inc. 1991.
- “Ultrasonic Flowmeter Basics,” Gabor Vass, *Sensors*, October, 1997.
- “Ultrasonic Flowmeters Pick Up Speed,” Murry Magness, *Control*, April, 1996.
- “User Tips for Mass, Volume Flowmeters,” Donald Ginesi and Carl Annarummo, *Intech*, April, 1994.

- Primary Element Options
- Pitot Tubes
- Variable Area Flowmeters

# Differential Pressure Flowmeters

The calculation of fluid flow rate by reading the pressure loss across a pipe restriction is perhaps the most commonly used flow measurement technique in industrial applications (Figure 2-1). The pressure drops generated by a wide variety of geometrical restrictions have been well characterized over the years, and, as compared in Table 2, these primary or “head” flow elements come in a wide variety of configurations, each with specific application strengths and weaknesses. Variations on the theme of differential pressure (d/p) flow measurement

unrestricted pipe. The pressure differential (h) developed by the flow element is measured, and the velocity (V), the volumetric flow (Q) and the mass flow (W) can all be calculated using the following generalized formulas:

$$\begin{aligned}
 &V = k (h/D)^{0.5} \\
 &\text{or } Q = kA(h/D)^{0.5} \\
 &\text{or } W = kA(hD)^{0.5}
 \end{aligned}$$

k is the discharge coefficient of the element (which also reflects the units of measurement), A is the cross-sectional area of the pipe’s opening, and D is the density of the flowing

Engineers (ASME), and the American Gas Association (AGA), and are included in many of the works listed as references at the end of this chapter.

The discharge coefficients of primary elements are determined by laboratory tests that reproduce the geometry of the installation. Published values generally represent the average value for that geometry over a minimum of 30 calibration runs. The uncertainties of these published values vary from 0.5% to 3%. By using such published discharge coefficients, it is possible to obtain reasonably accurate flow measurements without in-place calibration. In-place calibration is required if testing laboratories are not available or if better accuracy is desired than that provided by the uncertainty range noted above. The relationship between flow and pressure drop varies with the velocity profile, which can be laminar or turbulent (Figure 2-1) as a function of the Reynolds number (Re), which for liquid flows can be calculated using the relationship:

$$Re = 3160(SG)(Q)/(ID)\mu$$

where ID is the inside diameter of the pipe in inches, Q is the volumetric liquid flow in gallons/minute, SG is the fluid specific gravity at 60°F, and  $\mu$  is the viscosity in centipoises.

At low Reynolds numbers (generally under Re = 2,000), the flow is laminar and the velocity profile is parabolic. At high Reynolds numbers (well over Re = 3,000), the flow becomes fully turbulent, and the resulting mixing action produces a uniform axial velocity across the pipe. As shown in Figure 1-5, the

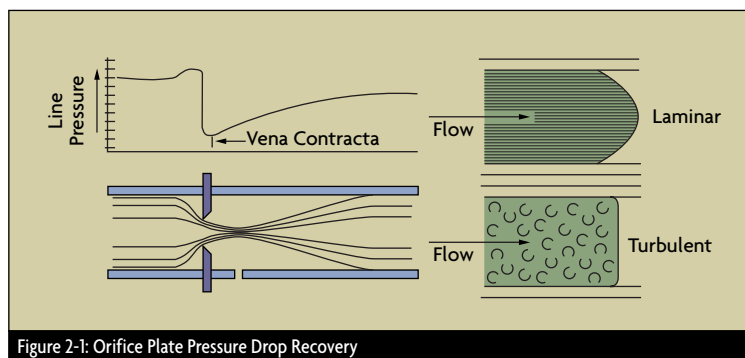

Figure 2-1: Orifice Plate Pressure Drop Recovery

include the use of pitot tubes and variable-area meters (rotameters), and are discussed later in this chapter.

## Primary Element Options

In the 18th century, Bernoulli first established the relationship between static and kinetic energy in a flowing stream. As a fluid passes through a restriction, it accelerates, and the energy for this acceleration is obtained from the fluid’s static pressure. Consequently, the line pressure drops at the point of constriction (Figure 2-1). Part of the pressure drop is recovered as the flow returns to the

fluid. The discharge coefficient k is influenced by the Reynolds number (see Figure 1-5) and by the “beta ratio,” the ratio between the bore diameter of the flow restriction and the inside diameter of the pipe.

Additional parameters or correction factors can be used in the derivation of k, depending on the type of flow element used. These parameters can be computed from equations or read from graphs and tables available from the American National Standards Institute (ANSI), the American Petroleum Institute (API), the American Society of Mechanical



transition between laminar and turbulent flows can cover a wide range of Reynolds numbers; the relationship with the discharge coefficient is a function of the particular primary element.

Today, many engineering societies and organizations and most primary

find the recommended size, although these results should be checked for reasonableness by hand calculation.

• **Accuracy & Rangeability**

The performance of a head-type flowmeter installation is a function of the precision of the flow element

ential pressure range of 100:1, the flowmeter would have an error of ±20% AR. For this reason, differential producing flowmeters have historically been limited to use within a 3:1 or 4:1 range.

Flowmeter rangeability can be further increased without adverse effect

**Table 3: Primary or "Head Flow" Element Comparisons**

PRIMARY ELEMENT	RECOMMENDED SERVICE	MINIMUM RE LIMITS	SIZES	ADVANTAGES	LIMITATIONS
Square edge concentric orifice plate	Clean liquids, gases, steam	≥2000	≥1/2 in	Easy to install Low cost Easy to replace	Relaxation piping requirements High head loss Accuracy affected by installation and orifice condition
Conical/quadrant edge concentric orifice plate	Viscous liquids	≥500	1 to 6 in	Easy to install Low cost Easy to replace	Relaxation piping requirements High head loss Accuracy affected by installation and orifice condition
Eccentric/segmental orifice plate	Liquids and gases containing secondary fluid phases	>10,000	4 to 14 in	Easy to install Low cost Easy to replace	Relaxation piping requirements High head loss Accuracy affected by installation and orifice condition Higher uncertainties of discharge coefficient data
Integral orifice	Clean liquids, gases, steam	>10,000	1/2 to 2 in	Easy to install No lead lines Low cost	Relaxation piping requirements Proprietary design requires calibration High head loss More prone to clogging than standard orifice plate
Venturi/flowtube	Clean & dirty liquids, gases, steam; slurries	>75,000	1/2 to 72 in	Low head loss 2 to 9 times less relaxation piping than orifice Higher flow capacity than orifice for the same differential pressure Accuracy less affected by wear and installation conditions than orifice	High initial cost
Nozzle	Clean liquids, gases, steam	>50,000	>2 in	Higher flow capacity than orifice for the same differential pressure Accuracy less affected by wear and installation conditions than orifice Good for high temperature and high velocity applications Mass transfer standard for gases	Harder to replace than orifice High head loss
Segmental wedge	Dirty liquids, gases, steam; slurries; viscous liquids	>500	≥1/2 in	No lead lines Minimal clogging potential 40% less head loss than orifice Minimal relaxation piping	Proprietary design needs calibration High initial cost Requires remote seal differential pressure transmitter, harder to zero
Venturi cone	Clean & dirty liquids, gases, steam; viscous liquids	None cited	1 to 16 in	Minimal relaxation piping Low flow capability	Proprietary design

element manufacturers offer software packages for sizing d/p flow elements. These programs include the required data from graphs, charts, and tables as well as empirical equations for flow coefficients and correction factors. Some include data on the physical properties of many common fluids. The user can simply enter the application data and automatically

and of the accuracy of the d/p cell. Flow element precision is typically reported in percentage of actual reading (AR) terms, whereas d/p cell accuracy is a percentage of calibrated span (CS). A d/p cell usually provides accuracy of ±0.2% of the calibrated span (CS). This means that, at the low end of a 10:1 flow range (at 10% flow), corresponding to a differ-

on accuracy by operating several d/p flowmeters in parallel runs. Only as many runs are opened at a time as are needed to keep the flow in the active ones at around 75-90% of range. Another option is to stack two or more transmitters in parallel onto the same element, one for 1-10%, the other for 10-100% of full scale (FS) d/p produced. Both of these

techniques are cumbersome and expensive. Intelligent transmitters offer a better option.

The accuracy of intelligent transmitters is usually stated as  $\pm 0.1\%$  CS, which includes only errors due to hysteresis, rangeability and linearity. Potential errors due to drift, temperature, humidity, vibration, overrange, radio frequency interference and power supply variation are all excluded. If one includes them, inaccuracy is about 0.2% CS. Because

compressible fluids, the ratio of differential pressure ( $h$ ) divided by upstream pressure ( $P$ ) should not exceed 0.25 (measured in the same engineering units).

Metering errors due to incorrect installation of the primary element can be substantial (up to 10%). Causes of such errors can be the condition of the mating pipe sections, insufficient straight pipe runs, and pressure tap and lead line design errors.

inverse derivative algorithm, which blocks any rate of change occurring more quickly than the rate at which the process flow can change.

• **Piping, Installation, & Maintenance**

Installation guidelines are published by various professional organizations (ISA, ANSI, API, ASME, AGA) and by manufacturers of proprietary designs. These guidelines include such recommendations as:

- When, in addition to measuring

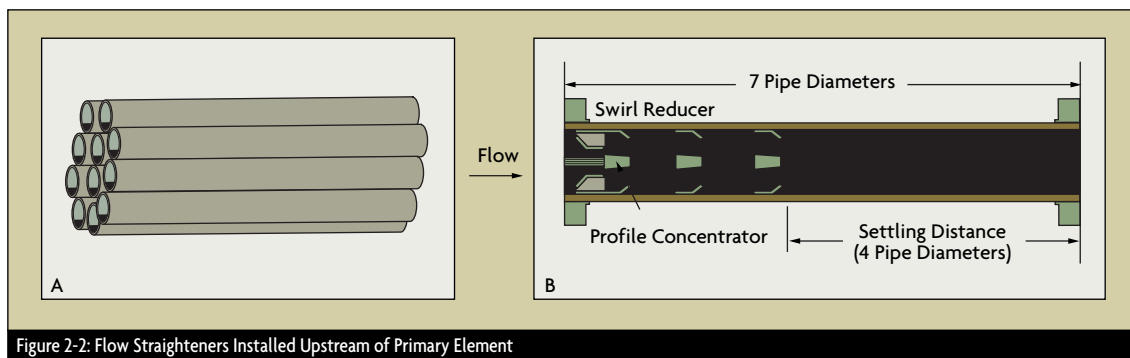

Figure 2-2: Flow Straighteners Installed Upstream of Primary Element

intelligent d/p transmitters can—based on their own measurements—automatically switch ranges between two calibrated spans (one for 1-10%, the other for 10-100% of FS d/p), it should be possible to obtain orifice installations with 1% AR inaccuracy over a 10:1 flow range.

In most flowmetering applications, density is not measured directly. Rather, it is assumed to have some normal value. If density deviates from this assumed value, error results. Density error can be corrected if it is measured directly or indirectly by measuring pressure in gases or temperature in liquids. Flow computing packages are also available that accept the inputs of the d/p transmitter and the other sensors and can simultaneously calculate mass and volumetric flow.

To minimize error (and the need for density correction) when dealing with

Under turbulent flow conditions, as much as 10% of the d/p signal can be noise caused by disturbances from valves and fittings, both up- and downstream of the element, and by the element itself. In the majority of applications, the damping provided in d/p cells is sufficient to filter out the noise. Severe noise can be reduced by the use of two or more pressure taps connected in parallel on both sides of the d/p cell.

Pulsating flow can be caused by reciprocating pumps or compressors. This pulsation can be reduced by moving the flowmeter away from the source of the pulse, or downstream of filters or other dampening devices. Pulsation dampening hardware can also be installed at the pressure taps, or dampening software can applied to the d/p cell output signal. One such filter is the

the flow, the process temperature or pressure is also to be measured, the pressure transmitter should not be installed in the process pipe, but should be connected to the appropriate lead line of the flow element via a tee.

- Similarly, the thermowell used for temperature measurement should be installed at least 10 diameters downstream of the flow element, to prevent velocity profile distortions.
- Welds should be ground smooth and gaskets trimmed so that no protrusion can be detected by physical inspection.

In order for the velocity profile to fully develop (and the pressure drop to be predictable), straight pipe runs are required both up- and downstream of the d/p element. The amount of straight run required depends on both the beta ratio of

the installation and on the nature of the upstream components in the pipeline. For example, when a single 90° elbow precedes an orifice plate, the straight-pipe requirement ranges from 6 to 20 pipe diameters as the diameter ratio is increased from 0.2 to 0.8.

In order to reduce the straight run requirement, flow straighteners (Figure 2-2) such as tube bundles, perforated plates, or internal tabs can be installed upstream of the primary element.

The size and orientation of the pressure taps are a function of both the pipe size and the type of process fluid. The recommended maximum diameter of pressure tap holes through the pipe or flange is 1/4" for pipes under 2" in diameter, 3/8" for 2" and 3" pipes, 1/2" for 4 to 8" and 3/4" for larger pipes. Both taps should be of the same diameter, and, where the hole breaks through the inside pipe surface, it should be square with no roughness, burrs, or wire edges. Connections to pressure holes should be made by nipples, couplings, or adaptors welded to the outside surface of the pipe.

On services where the process fluid can plug the pressure taps or might gel or freeze in the lead lines, chemical seal protectors can be used. Connection sizes are usually larger (seal elements can also be provided with diaphragm extensions), and, because of the space requirement, they are usually installed at "radius tap" or "pipe tap" locations, as shown in Figure 2-3. When chemical seals are used, it is important that the two connecting capillaries, as they are routed to the d/p cell, experience the same temperature and are kept shielded from sunlight.

The d/p transmitter should be

located as close to the primary element as possible. Lead lines should be as short as possible and of the same diameter. In clean liquid service, the minimum diameter is 1/4", while in condensable vapor service, the minimum diameter is 0.4". In steam service, the horizontal lead lines should be kept as short as possible and be tilted (with a minimum gradient of 1 in/ft with respect to the piping) towards the tap, so that condensate can drain back into the pipe. Again, both lead lines should be exposed to the same ambient conditions and be shielded from sunlight. In clean liquid or gas service, the lead lines can be purged through the d/p

out the difference, as long as that difference does not change.

If the process temperature exceeds the maximum temperature limitation of the d/p cell, either chemical seals have to be used or the lead lines need to be long enough to cool the fluid. If a large temperature drop is required, a coiled section of tubing (pigtail) can be installed in the lead lines to cool the process fluids.

The frequency of inspection or replacement of a primary element depends on the erosive and corrosive nature of the process and on the overall accuracy required. If there is no previous experience, the orifice plate can be removed for inspection

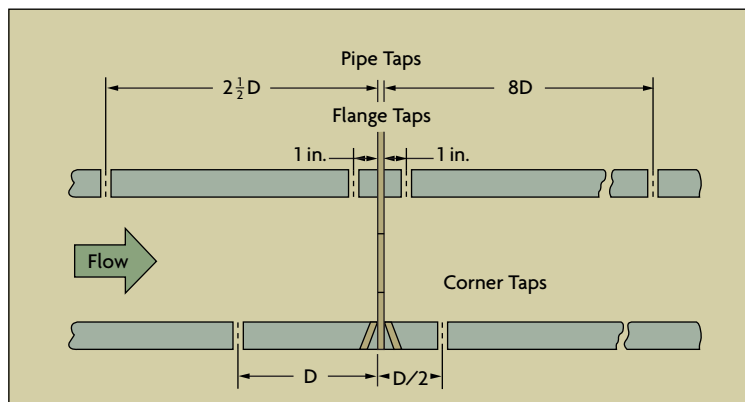

Figure 2-3: Differential Pressure Tap Location Alternatives

cell vent or drain connections, and they should be flushed for several minutes to remove all air from the lines. Entrapped air can offset the zero calibration.

Seal pots are on the wet leg in d/p cell installations with small ranges (under 10 in H<sub>2</sub>O) in order to minimize the level variation in the legs. In steam applications, filling tees are recommended to ensure equal height condensate legs on both sides of the d/p cell. If for some reason the two legs are not of equal height, the d/p cell can be biased to zero

during the first three, six, and 12 months of its operation. Based on visual inspection of the plate, a reasonable maintenance cycle can be extrapolated from the findings. Orifices used for material balance calculations should be on the same maintenance cycle.

• **Sizing the Orifice Plate**

The orifice plate is commonly used in clean liquid, gas, and steam service. It is available for all pipe sizes, and if the pressure drop it requires is free, it is very cost-effective for

measuring flows in larger pipes (over 6" diameter). The orifice plate is also approved by many standards organizations for the custody transfer of liquids and gases.

The orifice flow equations used today still differ from one another, although the various standards organizations are working to adopt a single, universally accepted orifice flow equation. Orifice sizing programs usually allow the user to select the flow equation desired from among several.

The orifice plate can be made of any material, although stainless steel is the most common. The thickness of the plate used ( $1/8$ - $1/2$ " ) is a function of the line size, the process temperature, the pressure, and the differential pressure. The traditional orifice is a thin circular plate (with a tab for handling and for data), inserted

process without depressurizing the line and shutting down flow. In such fittings, the universal orifice plate, a circular plate with no tab, is used.

The concentric orifice plate (Figure 2-4A) has a sharp (square-edged) concentric bore that provides an almost pure line contact between the plate and the fluid, with negligible friction drag at the boundary. The beta (or diameter) ratios of concentric orifice plates range from 0.25 to 0.75. The maximum velocity and minimum static pressure occurs at some 0.35 to 0.85 pipe diameters downstream from the orifice plate. That point is called the vena contracta. Measuring the differential pressure at a location close to the orifice plate minimizes the effect of pipe roughness, since friction has an effect on the fluid and the pipe wall.

Flange taps are predominantly

(Figure 2-3). With corner taps, the relatively small clearances represent a potential maintenance problem. Vena contracta taps (which are close to the radius taps, Figure 2-4) are located one pipe diameter upstream from the plate, and downstream at the point of vena contracta. This location varies (with beta ratio and Reynolds number) from  $0.35D$  to  $0.8D$ .

The vena contracta taps provide the maximum pressure differential, but also the most noise. Additionally, if the plate is changed, it may require a change in the tap location. Also, in small pipes, the vena contracta might lie under a flange. Therefore, vena contracta taps normally are used only in pipe sizes exceeding six inches.

Radius taps are similar to vena contracta taps, except the downstream tap is fixed at  $0.5D$  from the

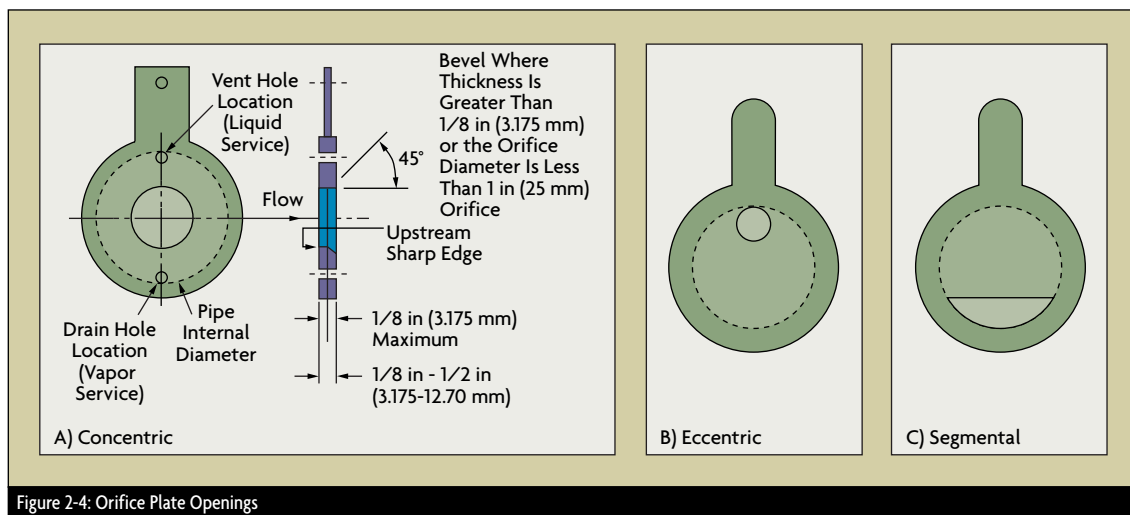

into the pipeline between the two flanges of an orifice union. This method of installation is cost-effective, but it calls for a process shutdown whenever the plate is removed for maintenance or inspection. In contrast, an orifice fitting allows the orifice to be removed from the

used in the United States and are located 1 inch from the orifice plate's surfaces (Figure 2-3). They are not recommended for use on pipelines under 2 inches in diameter. Corner taps are predominant in Europe for all sizes of pipe, and are used in the United States for pipes under 2 inches

orifice plate (Figure 2-3). Pipe taps are located 2.5 pipe diameters upstream and 8 diameters downstream from the orifice (Figure 2-3). They detect the smallest pressure difference and, because of the tap distance from the orifice, the effects of pipe roughness, dimensional inconsistencies,

and, therefore, measurement errors are the greatest.

• **Orifice Types & Selection**

The concentric orifice plate is recommended for clean liquids, gases, and steam flows when Reynolds numbers range from 20,000 to  $10^7$  in pipes under six inches. Because the basic orifice flow equations assume that flow velocities are well below sonic, a different theoretical and computational approach is required if sonic velocities are expected. The minimum recommended Reynolds number for flow through an orifice (Figure 1-5) varies with the beta ratio of the orifice and with the pipe size. In larger size pipes, the minimum Reynolds number also rises.

Because of this minimum Reynolds number consideration, square-edged orifices are seldom used on viscous fluids. Quadrant-edged and conical orifice plates (Figure 2-5) are recommended when the Reynolds number is under 10,000. Flange taps, corner, and radius taps can all be used with quadrant-edged orifices, but only corner taps should be used with a conical orifice.

Concentric orifice plates can be provided with drain holes to prevent buildup of entrained liquids in gas streams, or with vent holes for venting entrained gases from liquids (Figure 2-4A). The unmeasured flow passing through the vent or drain hole is usually less than 1% of the total flow if the hole diameter is less than 10% of the orifice bore. The effectiveness of vent/drain holes is limited, however, because they often plug up.

Concentric orifice plates are not recommended for multi-phase fluids in horizontal lines because the secondary phase can build up

around the upstream edge of the plate. In extreme cases, this can clog the opening, or it can change the flow pattern, creating measurement error. Eccentric and segmental orifice plates are better suited for such applications. Concentric orifices are still preferred for multi-phase flows in vertical lines because accumulation of material is less likely and the sizing data for these plates is more reliable.

The eccentric orifice (Figure 2-4B)

These plates are usually used in pipe sizes exceeding four inches in diameter, and must be carefully installed to make sure that no portion of the flange or gasket interferes with the opening. Flange taps are used with both types of plates, and are located in the quadrant opposite the opening for the eccentric orifice, in line with the maximum dam height for the segmental orifice.

For the measurement of low flow rates, a  $d/p$  cell with an integral

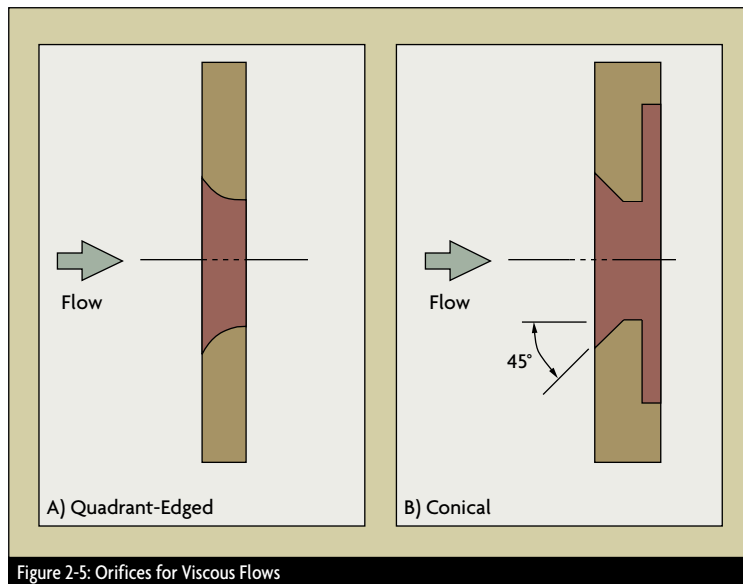

Figure 2-5: Orifices for Viscous Flows

is similar to the concentric except that the opening is offset from the pipe's centerline. The opening of the segmental orifice (Figure 2-4C) is a segment of a circle. If the secondary phase is a gas, the opening of an eccentric orifice will be located towards the top of the pipe. If the secondary phase is a liquid in a gas or a slurry in a liquid stream, the opening should be at the bottom of the pipe. The drainage area of the segmental orifice is greater than that of the eccentric orifice, and, therefore, it is preferred in applications with high proportions of the secondary phase.

orifice may be the best choice. In this design, the total process flow passes through the  $d/p$  cell, eliminating the need for lead lines. These are proprietary devices with little published data on their performance; their flow coefficients are based on actual laboratory calibrations. They are recommended for clean, single-phase fluids only because even small amounts of build-up will create significant measurement errors or will clog the unit. Restriction orifices are installed to remove excess pressure and usually operate at sonic velocities with very small beta ratios. The pressure drop



across a single restriction orifice should not exceed 500 psid because of plugging or galling. In multi-element restriction orifice installations, the plates are placed approximately one pipe diameter from one another in order to prevent pressure recovery between the plates.

• **Orifice Performance**

Although it is a simple device, the orifice plate is, in principle, a precision instrument. Under ideal conditions, the inaccuracy of an orifice plate can be in the range of 0.75-1.5% AR. Orifice plates are, however, quite

process pipe, adequacy of straight pipe runs, gasket interference, misalignment of pipe and orifice bores, and lead line design. Other adverse conditions include the dulling of the sharp edge or nicks caused by corrosion or erosion, warpage of the plate due to waterhammer and dirt, and grease or secondary phase deposits on either orifice surface. Any of the above conditions can change the orifice discharge coefficient by as much as 10%. In combination, these problems can be even more worrisome and the net effect unpredictable. Therefore, under average operating

laboratory and is provided with honed pipe sections, flow straighteners, senior orifice fittings, and temperature controlled enclosures.

• **Venturi & Flowtubes**

Venturi tubes are available in sizes up to 72", and can pass 25 to 50% more flow than an orifice with the same pressure drop. Furthermore, the total unrecovered head loss rarely exceeds 10% of measured d/p (Figure 2-6). The initial cost of venturi tubes is high, so they are primarily used on larger flows or on more difficult or demanding flow applications. Venturis are insensitive to velocity profile effects and therefore require less straight pipe run than an orifice. Their contoured nature, combined with the self-scouring action of the flow through the tube, makes the device immune to corrosion, erosion, and internal scale build up. In spite of its high initial cost, the total cost of ownership can still be favorable because of savings in installation and operating and maintenance costs.

The classical Herschel venturi has a very long flow element characterized by a tapered inlet and a diverging outlet. Inlet pressure is measured at the entrance, and static pressure in the throat section. The pressure taps feed into a common annular chamber, providing an average pressure reading over the entire circumference of the element. The classical venturi is limited in its application to clean, non-corrosive liquids and gases.

In the short form venturi, the entrance angle is increased and the annular chambers are replaced by pipe taps (Figure 2-7A). The short-form venturi maintains many of the advantages of the classical venturi, but at a reduced initial cost, shorter

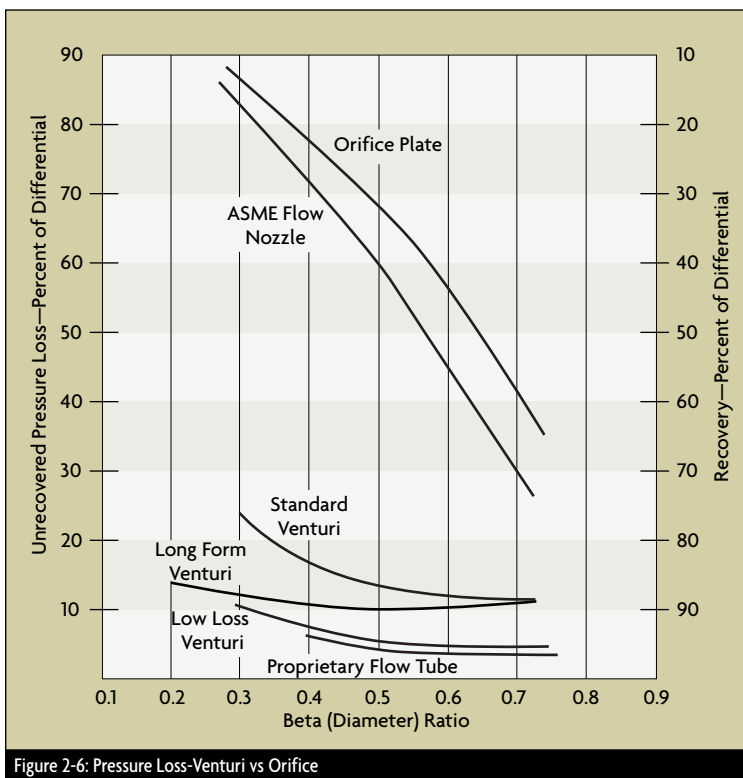

Figure 2-6: Pressure Loss-Venturi vs Orifice

sensitive to a variety of error-inducing conditions. Precision in the bore calculations, the quality of the installation, and the condition of the plate itself determine total performance. Installation factors include tap location and condition, condition of the

conditions, a typical orifice installation can be expected to have an overall inaccuracy in the range of 2 to 5% AR.

The typical custody-transfer grade orifice meter is more accurate because it can be calibrated in a testing

length and reduced weight. Pressure taps are located  $\frac{1}{4}$  to  $\frac{1}{2}$  pipe diameter upstream of the inlet cone, and in

$Re > 200,000$  is between 0.7 and 1.5%. Flowtubes are often supplied with discharge coefficient graphs because

usually coupled to the d/p transmitter using filled capillaries. Overall measurement accuracy can drop if the

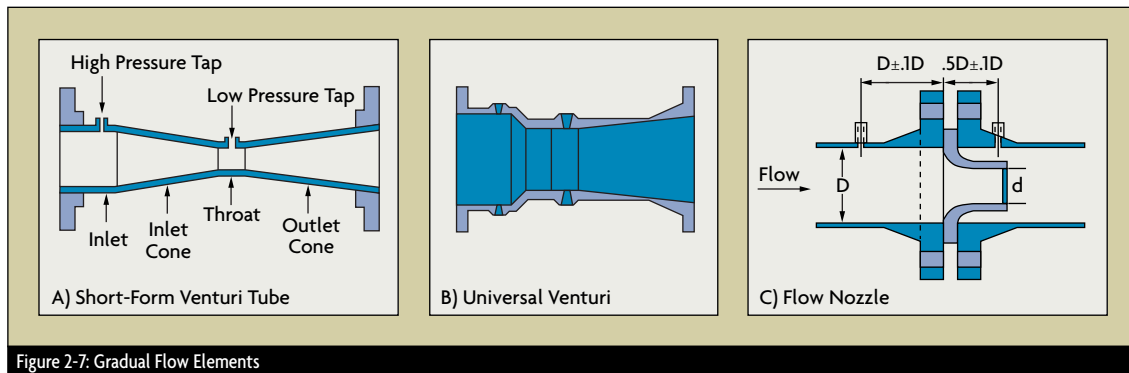

Figure 2-7: Gradual Flow Elements

the middle of the throat section. Piezometer rings can be used with large venturi tubes to compensate for velocity profile distortions. In slurry service, the pipe taps can be purged or replaced with chemical seals, which can eliminate all dead-ended cavities.

There are several proprietary flowtube designs which provide even better pressure recovery than the classical venturi. The best known of these proprietary designs is the universal venturi (Figure 2-7B). The various flowtube designs vary in their contours, tap locations, generated d/p and in their unrecovered head loss. They all have short lay lengths, typically varying between 2 and 4 pipe diameters. These proprietary flowtubes usually cost less than the classical and short-form venturis because of their short lay length. However, they may also require more straight pipe run to condition their flow velocity profiles.

Flowtube performance is much affected by calibration. The inaccuracy of the discharge coefficient in a universal venturi, at Reynolds numbers exceeding 75,000, is 0.5%. The inaccuracy of a classical venturi at

the discharge coefficient changes as the Reynolds number drops. The variation in the discharge coefficient of a venturi caused by pipe roughness is less than 1% because there is continuous contact between the fluid and the internal pipe surface.

The high turbulence and the lack of cavities in which material can accumulate make flow tubes well suited for slurry and sludge services. However, maintenance costs can be high if air purging cannot prevent plugging of the pressure taps and lead lines. Plunger-like devices (vent cleaners) can be installed to periodically

chemical seal is small, its diaphragm is stiff, or if the capillary system is not temperature-compensated or not shielded from direct sunlight.

• Flow Nozzles

The flow nozzle is dimensionally more stable than the orifice plate, particularly in high temperature and high velocity services. It has often been used to measure high flowrates of superheated steam. The flow nozzle, like the venturi, has a greater flow capacity than the orifice plate and requires a lower initial investment than a venturi

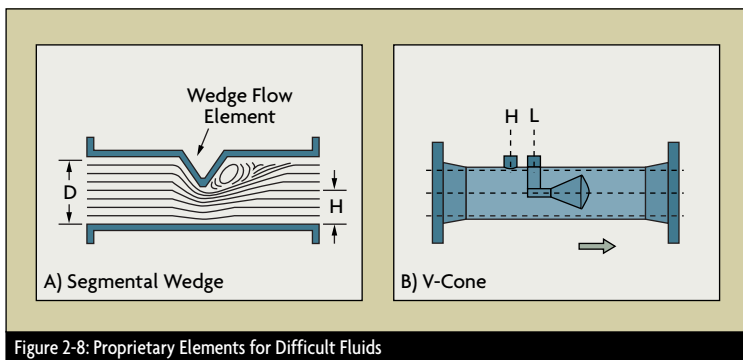

Figure 2-8: Proprietary Elements for Difficult Fluids

remove buildup from interior openings, even while the meter is online. Lead lines can also be replaced with button-type seal elements hydraulically

coupled to the d/p transmitter using filled capillaries. Overall measurement accuracy can drop if the

orifice unless it can be removed as part of a spool section.

The ASME pipe tap flow nozzle is predominant in the United States (Figure 2-7C). The downstream end of a nozzle is a short tube having the same diameter as the vena contracta of an equivalent orifice plate. The low-beta designs range in diameter ratios from 0.2 to 0.5, while the high beta-ratio designs vary between 0.45 and 0.8. The nozzle should always be centered in the pipe, and the downstream pressure tap should be inside the nozzle exit. The throat taper should always decrease the diameter toward the exit. Flow nozzles are not recommended for slurries or dirty fluids. The most common flow nozzle is the flange type. Taps are commonly located one pipe diameter upstream and 1/2 pipe diameter downstream from the inlet face.

Flow nozzle accuracy is typically

accurate way to measure gas flows. When the gas velocity reaches the speed of sound in the throat, the velocity cannot increase any more (even if downstream pressure is reduced), and a choked flow condition is reached. Such “critical flow nozzles” are very accurate and often are used in flow laboratories as standards for calibrating other gas flowmetering devices.

Nozzles can be installed in any position, although horizontal orientation is preferred. Vertical downflow is preferred for wet steam, gases, or liquids containing solids. The straight pipe run requirements are similar to those of orifice plates.

• **Segmental Wedge Elements**

The segmental wedge element (Figure 2-8A) is a proprietary device designed for use in slurry, corrosive, erosive, viscous, or high-temperature applications. It is relatively expensive and is

dead-ended cavities. The seals attach to the meter body immediately upstream and downstream of the restriction. They rarely require cleaning, even in services like dewatered sludge, black liquor, coal slurry, fly ash slurry, taconite, and crude oil. The minimum Reynolds number is only 500, and the meter requires only five diameters of upstream straight pipe run.

The segmental wedge has a V-shaped restriction characterized by the H/D ratio, where H is the height of the opening below the restriction and D is the diameter. The H/D ratio can be varied to match the flow range and to produce the desired d/p. The oncoming flow creates a sweeping action through the meter. This provides a scouring effect on both faces of the restriction, helping to keep it clean and free of buildup. Segmental wedges can measure flow in both directions, but the d/p transmitter must be calibrated for a split range, or the flow element must be provided with two sets of connections for two d/p transmitters (one for forward and one for reverse flow).

An uncalibrated wedge element can be expected to have a 2% to 5% AR inaccuracy over a 3:1 range. A calibrated wedge element can reduce that to 0.5% AR if the fluid density is constant. If slurry density is variable and/or unmeasured, error rises.

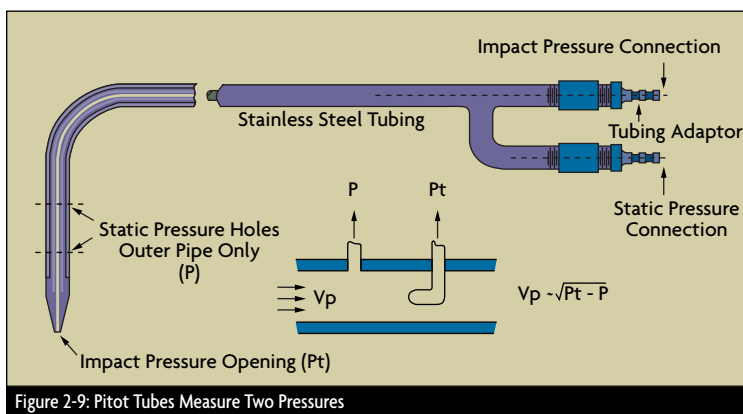

1% AR, with a potential for 0.25% AR if calibrated. While discharge coefficient data is available for Reynolds numbers as low as 5,000, it is advisable to use flow nozzles only when the Reynolds number exceeds 50,000. Flow nozzles maintain their accuracy for long periods, even in difficult service. Flow nozzles can be a highly

used mostly on difficult fluids, where the dramatic savings in maintenance can justify the initial cost. The unique flow restriction is designed to last the life of the installation without deterioration.

Wedge elements are used with 3-in diameter chemical seals, eliminating both the lead lines and any

• **Venturi-Cone Element**

The venturi-cone (V-cone) element (Figure 2-8B) is another proprietary design that promises consistent performance at low Reynolds numbers and is insensitive to velocity profile distortion or swirl effects. Again, however, it is relatively expensive. The V-cone restriction has a unique geometry

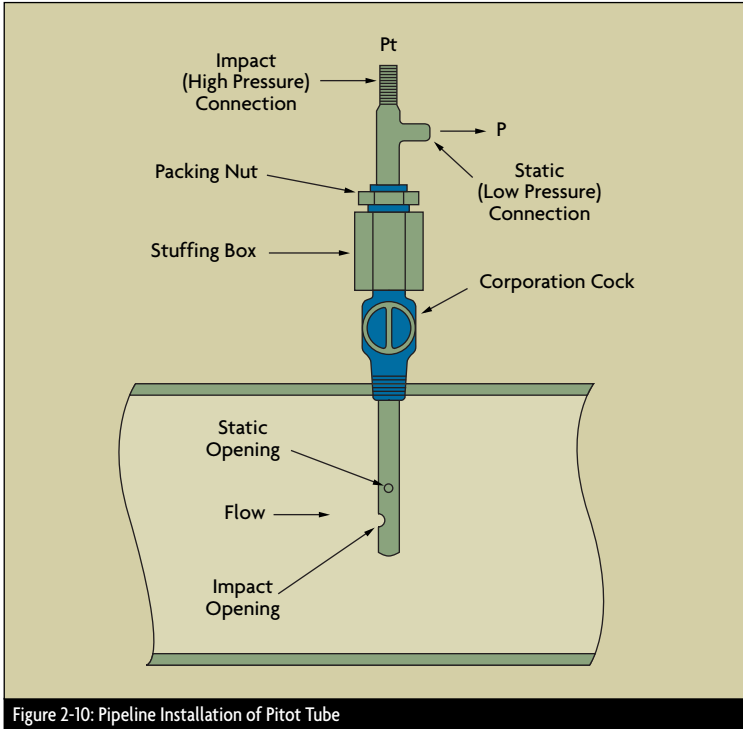

Figure 2-10: Pipeline Installation of Pitot Tube

that minimizes accuracy degradation due to wear, making it a good choice for high velocity flows and erosive/corrosive applications.

The V-cone creates a controlled turbulence region that flattens the incoming irregular velocity profile and induces a stable differential pressure that is sensed by a downstream tap. The beta ratio of a V-cone is so defined that an orifice and a V-cone with equal beta ratios will have equal opening areas.

$$\text{Beta ratio} = (D^2 - d^2)^{0.5} / D$$

where  $d$  is the cone diameter and  $D$  is the inside diameter of the pipe.

With this design, the beta ratio can exceed 0.75. For example, a 3-in meter with a beta ratio of 0.3 can have a 0 to 75 gpm range. Published test results on liquid and gas flows place the system accuracy between 0.25 and 1.2% AR.

### Pitot Tubes

Although the pitot tube is one of the simplest flow sensors, it is used in a wide range of flow measurement applications such as air speed in racing cars and Air Force fighter jets. In industrial applications, pitot tubes are used to measure air flow in pipes, ducts, and stacks, and liquid flow in pipes, weirs, and open channels. While accuracy and rangeability are relatively low, pitot tubes are simple, reliable, inexpensive, and suited for a variety of environmental conditions, including extremely high temperatures and a wide range of pressures.

The pitot tube is an inexpensive alternative to an orifice plate. Accuracy ranges from 0.5% to 5% FS, which is comparable to that of an orifice. Its flow rangeability of 3:1 (some operate at 4:1) is also similar to the capability of the orifice plate. The main difference is that,

while an orifice measures the full flowstream, the pitot tube detects the flow velocity at only one point in the flowstream. An advantage of the slender pitot tube is that it can be inserted into existing and pressurized pipelines (called hot-tapping) without requiring a shutdown.

### Theory of Operation

Pitot tubes were invented by Henri Pitot in 1732 to measure the flowing velocity of fluids. Basically a differential pressure ( $d/p$ ) flowmeter, a pitot tube measures two pressures: the static and the total impact pressure. The static pressure is the operating pressure in the pipe, duct, or the environment, upstream to the pitot tube. It is measured at right angles to the flow direction, preferably in a low turbulence location (Figure 2-9).

The total impact pressure ( $P_T$ ) is the sum of the static and kinetic pressures and is detected as the flowing stream impacts on the pitot opening. To measure impact pressure, most pitot tubes use a small,

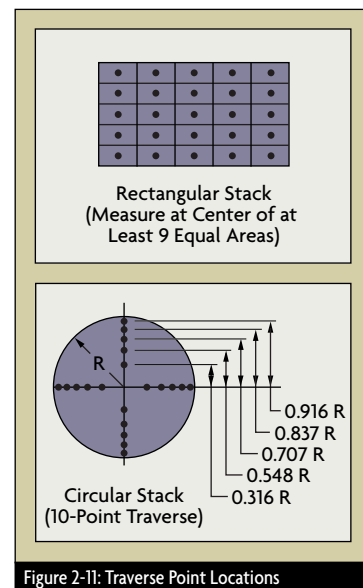

Figure 2-11: Traverse Point Locations

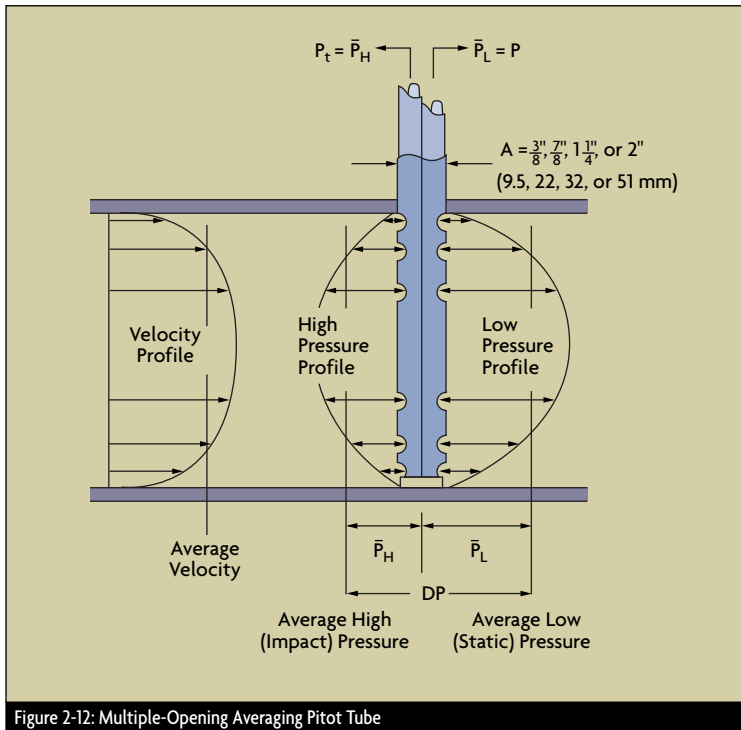

Figure 2-12: Multiple-Opening Averaging Pitot Tube

sometimes L-shaped tube, with the opening directly facing the oncoming flowstream. The point velocity of approach ( $V_p$ ) can be calculated by taking the square root of the difference between the total pressure ( $P_T$ ) and the static pressure ( $P$ ) and multiplying that by the  $C/D$  ratio, where  $C$  is a dimensional constant and  $D$  is density:

$$V_p = C(P_T - P)^{1/2} / D$$

When the flowrate is obtained by multiplying the point velocity ( $V_p$ ) by the cross-sectional area of the pipe or duct, it is critical that the velocity measurement be made at an insertion depth which corresponds to the average velocity. As the flow velocity rises, the velocity profile in the pipe changes from elongated (laminar) to more flat (turbulent). This changes the point of average velocity and

requires an adjustment of the insertion depth. Pitot tubes are recommended only for highly turbulent flows (Reynolds Numbers > 20,000) and, under these conditions, the velocity profile tends to be flat enough so that the insertion depth is not critical.

In 1797, G.B. Venturi developed a short tube with a throat-like passage that increases flow velocity and reduces the permanent pressure drop. Special pitot designs are available that, instead of providing just an impact hole for opening, add a single or double venturi to the impact opening of the pitot tube. The venturi version generates a higher differential pressure than does a regular pitot tube.

• **Static Pressure Measurement**

In jacketed (dual-walled) pitot-tube designs, the impact pressure port

faces forward into the flow, while static ports do not, but are, instead, spaced around the outer tube. Both pressure signals ( $P_T$  and  $P$ ) are routed by tubing to a d/p indicator or transmitter. In industrial applications, the static pressure ( $P$ ) can be measured in three ways: 1) through taps in the pipe wall; 2) by static probes inserted in the process stream; or 3) by small openings located on the pitot tube itself or on a separate aerodynamic element.

Wall taps can measure static pressures at flow velocities up to 200 ft/sec. A static probe (resembling an L-shaped pitot tube) can have four holes of 0.04 inches in diameter, spaced 90° apart. Aerodynamic bodies can be cylinders or wedges, with two or more sensing ports.

Errors in detecting static pressure arise from fluid viscosity, velocity, and fluid compressibility. The key to accurate static pressure detection is to minimize the kinetic component in the pressure measurement.

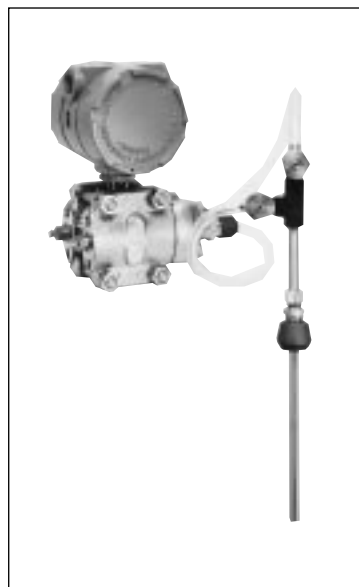

Pitot tube shown with associated fittings and pressure transmitter.



• **Single-Port Pitot Tubes**

A single-port pitot tube can measure the flow velocity at only a single point in the cross-section of a flowing stream (Figure 2-10). The probe must be inserted to a point in the flowing stream where the flow velocity is the average of the velocities across the cross-section, and its impact port must face directly into the fluid flow. The pitot tube can be made less sensitive to flow direction if the impact port has an internal bevel of about 15°, extending about 1.5 diameters into the tube.

If the pressure differential generated by the venturi is too low for accurate detection, the conventional pitot tube can be replaced by a pitot venturi or a double venturi sensor. This will produce a higher pressure differential.

A calibrated, clean and properly inserted single-port pitot tube can provide ±1% of full scale flow accuracy over a flow range of 3:1; and, with some loss of accuracy, it can even measure over a range of 4:1. Its advantages are low cost, no moving parts, simplicity, and the fact that it causes very little pressure loss in the flowing stream. Its main limitations include the errors resulting from velocity profile changes or from plugging of the pressure ports. Pitot tubes are generally used for flow measurements of secondary importance, where cost is a major concern, and/or when the pipe or duct diameter is large (up to 72 inches or more).

Specially designed pitot probes have been developed for use with pulsating flows. One design uses a pitot probe filled with silicone oil to transmit the process pressures to the d/p cell. At high frequency pulsating applications, the oil serves as a pulsation dampening and pressure-

averaging medium.

Pitot tubes also can be used in square, rectangular or circular air ducts. Typically, the pitot tube fits through a 5/16-in diameter hole in the duct. Mounting can be by a flange or gland. The tube is usually provided with an external indicator,

measure water velocity in open channels, at drops, chutes, or over fall crests. At the low flow velocities typical of laminar conditions, pitot tubes are not recommended because it is difficult to find the insertion depth corresponding to the average velocity and because

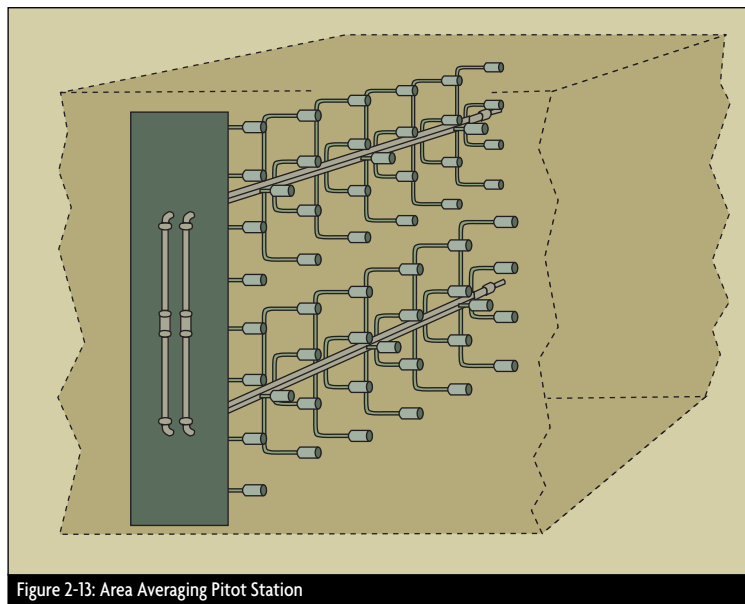

Figure 2-13: Area Averaging Pitot Station

so that its impact port can be accurately rotated to face directly into the flow. In addition, the tube can be designed for detecting the full velocity profile by making rapid and consistent traverses across the duct.

In some applications, such as EPA-mandated stack particulate sampling, it is necessary to traverse a pitot sampler across a stack or duct. In these applications, at each point noted in Figure 2-11, a temperature and flow measurement is made in addition to taking a gas sample, which data are then combined and taken to a laboratory for analysis. In such applications, a single probe contains a pitot tube, a thermocouple, and a sampling nozzle.

A pitot tube also can be used to

the pitot element produces such a small pressure differential. The use of a pitot venturi does improve on this situation by increasing the pressure differential, but cannot help the problem caused by the elongated velocity profile.

• **Averaging Pitot Tubes**

Averaging pitot tubes been introduced to overcome the problem of finding the average velocity point. An averaging pitot tube is provided with multiple impact and static pressure ports and is designed to extend across the entire diameter of the pipe. The pressures detected by all the impact (and separately by all the static) pressure ports are combined and the square root of their difference is measured as

an indication of the average flow in the pipe (Figure 2-12). The port closer to the outlet of the combined signal has a slightly greater influence, than the port that is farthest away, but, for secondary applications where pitot tubes are commonly used, this error is acceptable.

The number of impact ports, the distance between ports, and the diameter of the averaging pitot tube all can be modified to match the needs of a particular application. Sensing ports in averaging pitot tubes are often too large to allow the tube to behave as a true averaging chamber. This is because the oversized

same advantages and disadvantages as do single-port tubes. They are slightly more expensive and a little more accurate, especially if the flow is not fully formed. Some averaging pitot sensors can be inserted through the same opening (or hot tap) which accommodates a single-port tube.

• **Area Averaging**

Area-averaging pitot stations are used to measure the large flows of low pressure air in boilers, dryers, or HVAC systems. These units are available for the various standard sizes of circular or rectangular ducts (Figure 2-13) and for pipes. They are so

the manifolds can be purged to keep the ports clean.

Because area-averaging pitot stations generate very small pressure differentials, it may be necessary to use low differential d/p cells with spans as low as 0-0.01 in water column. To improve accuracy, a hexagonal cell-type flow straightener and a flow nozzle can be installed upstream of the area-averaging pitot flow sensor. The flow straightener removes local turbulence, while the nozzle amplifies the differential pressure produced by the sensor.

• **Installation**

Pitot tubes can be used as permanently installed flow sensors or as portable monitoring devices providing periodic data. Permanently installed carbon steel or stainless steel units can operate at up to 1400 PSIG pressures and are inserted into the pipe through flanged or screw connections. Their installation usually occurs prior to plant start-up, but they can be hot-tapped into an operating process.

In a hot-tap installation (Figure 2-14), one first welds a fitting to the pipe. Then a drill-through valve is attached to the fitting and a hole is drilled through the pipe. Then, after partially withdrawing the drill, the valve is closed, the drill is removed and the pitot tube is inserted. Finally, the valve is opened and the pitot tube is fully inserted.

The velocity profile of the flowing stream inside the pipe is affected by the Reynolds number of the flowing fluid, pipe surface roughness, and by upstream disturbances, such as valves, elbows, and other fittings. Pitot tubes should be used only if the minimum Reynolds number exceeds 20,000 and if either a straight run of about 25 diameters can be provided

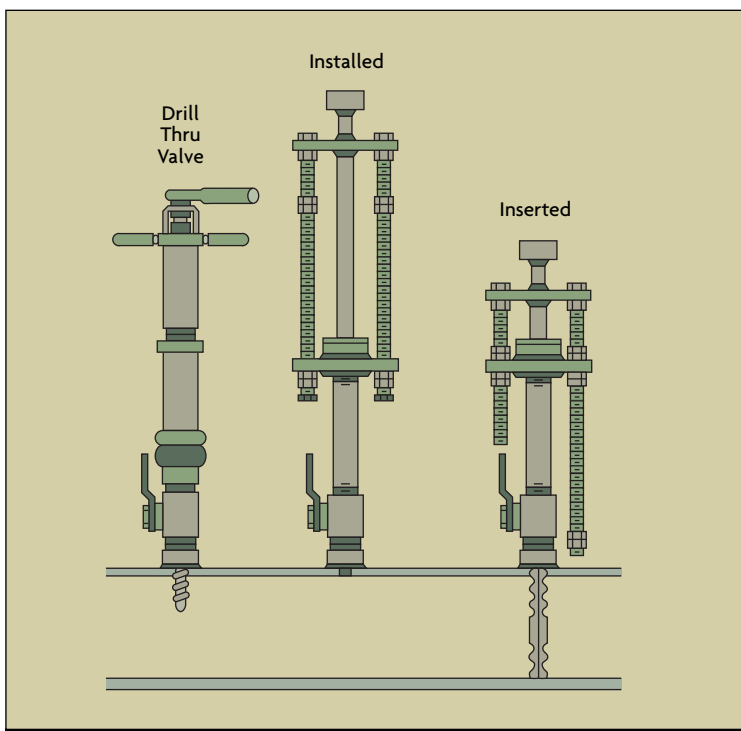

Figure 2-14: Hot Tap Installation of a Pitot Tube

port openings are optimized not for averaging, but to prevent plugging. In some installations, purging with an inert gas is used to keep the ports clean, allowing the sensor to use smaller ports.

Averaging pitot tubes offer the

designed that each segment of the cross-section is provided with both an impact and a static pressure port. Each set of ports is connected to its own manifold, which combines the average static and average impact pressure signals. If plugging is likely,

upstream to the pitot tube or if straightening vanes can be installed.

• **Vibration Damage**

Natural frequency resonant vibrations can cause pitot tube failure.

plus: 1.25 in for 3/8-in diameter probes; 1.5 in for 1/2-in; 1.56 in for 3/4-in; and 1.94 in for 1-in diameter probes.

Once the velocity limits have been calculated, make sure that they do not fall within the range of operating

spring is used to return the flow element to its resting position when the flow lessens. Gravity-operated meters (rotameters) must be installed in a vertical position, whereas spring operated ones can be mounted in any position.

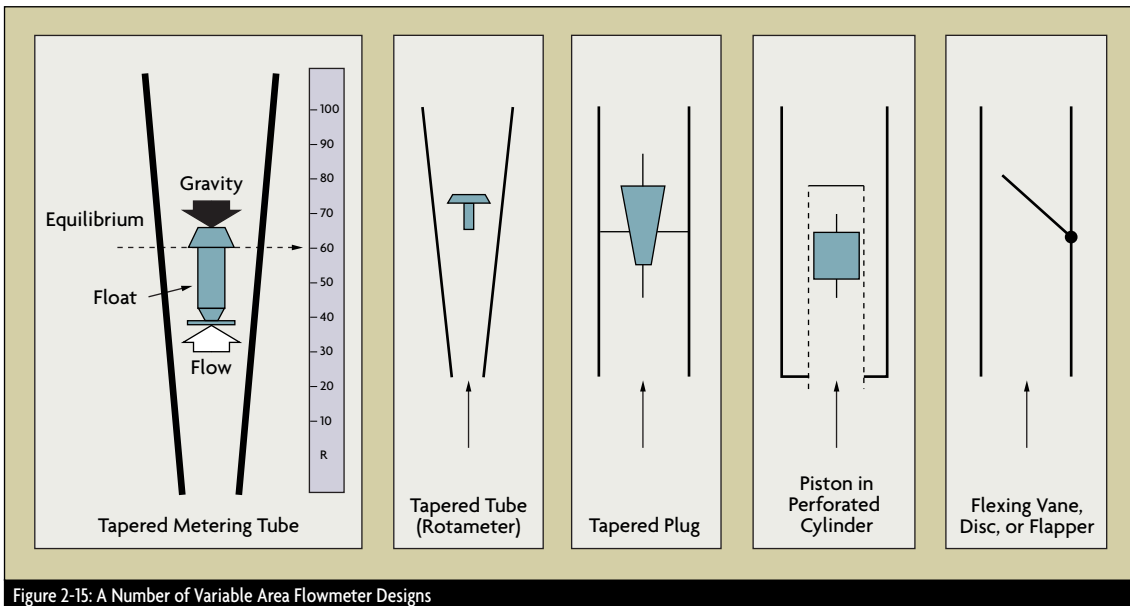

Figure 2-15: A Number of Variable Area Flowmeter Designs

Natural frequency vibration is caused by forces created as vortices are shed by the pitot tube. The pitot tube is expected to experience such vibration if the process fluid velocity (in feet per second) is between a lower limit (V<sub>L</sub>) and an upper limit (V<sub>H</sub>). The values of V<sub>L</sub> and V<sub>H</sub> can be calculated (for the products of a given manufacturer) using the equations below.

$$V_L = 5253(M \times Pr \times D)/L^2$$

$$V_H = 7879(M \times Pr \times D)/L^2$$

Where M = mounting factor (3.52 for single mount); Pr = probe factor (0.185 for 3/8-in diameter probes; 0.269 for 1/2-in; 0.372 for 3/4-in; and 0.552 for 1-in); D = probe diameter (inches); L = unsupported probe length in inches, which is calculated as the sum of the pipe I.D. plus the pipe wall thickness

velocities. If they do, change the probe diameter, or its mounting, or do both, until there is no overlap.

**Variable Area Flowmeters**

Variable area flowmeters (Figure 2-15) are simple and versatile devices that operate at a relatively constant pressure drop and measure the flow of liquids, gases, and steam. The position of their float, piston or vane is changed as the increasing flow rate opens a larger flow area to pass the flowing fluid. The position of the float, piston or vane provides a direct visual indication of flow rate. Design variations include the rotameter (a float in a tapered tube), orifice/rotameter combination (bypass rotameter), open-channel variable gate, tapered plug, and vane or piston designs.

Either the force of gravity or a

All variable area flowmeters are available with local indicators. Most can also be provided with position sensors and transmitters (pneumatic, electronic, digital, or fiberoptic) for connecting to remote displays or controls.

• **Purge-Flow Regulators**

If a needle valve is placed at the inlet or outlet of a rotameter, and a d/p regulator controls the pressure difference across this combination, the result is a purge-flow regulator. Such instrumentation packages are used as self-contained purge flowmeters (Figure 2-16). These are among the least expensive and most widely used flowmeters. Their main application is to control small gas or liquid purge streams. They are used to protect instruments from contacting hot and corrosive fluids, so

protect pressure taps from plugging, to protect the cleanliness of optical devices, and to protect electrical devices from igniting upon contact with combustibles.

Purge meters are quite useful in adding nitrogen gas to the vapor

and the inlet pressure ( $P_1$ ) is variable.

They can handle extremely small flow rates from 0.01 cc/min for liquids and from 0.5 cc/min for gases. The most common size is a glass tube rotameter with 1/4-in (6 mm) connections, a range of 0.05-0.5 gpm

combination of the buoyancy of the liquid and the velocity head of the fluid. With gases, buoyancy is negligible, and the float responds mostly to the velocity head.

In a rotameter (Figure 2-15), the metering tube is mounted vertically, with the small end at the bottom. The fluid to be measured enters at the bottom of the tube, passes upward around the float, and exits the top. When no flow exists, the float rests at the bottom. When fluid enters, the metering float begins to rise.

The float moves up and down in proportion to the fluid flow rate and the annular area between the float and the tube wall. As the float rises, the size of the annular opening increases. As this area increases, the differential pressure across the float decreases. The float reaches a stable position when the upward force exerted by the flowing fluid equals the weight of the float. Every float position corresponds to a particular flowrate for a particular fluid's density and viscosity. For this reason, it is necessary to size the rotameter for each application. When sized correctly, the flow rate can be determined by matching the float position to a calibrated scale on the outside of the rotameter. Many rotameters come with a built-in valve for adjusting flow manually.

Several shapes of float are available for various applications. One early design had slots, which caused the float to spin for stabilizing and centering purposes. Because this float rotated, the term rotameter was coined.

Rotameters are typically provided with calibration data and a direct reading scale for air or water (or both). To size a rotameter for other service, one must first convert the

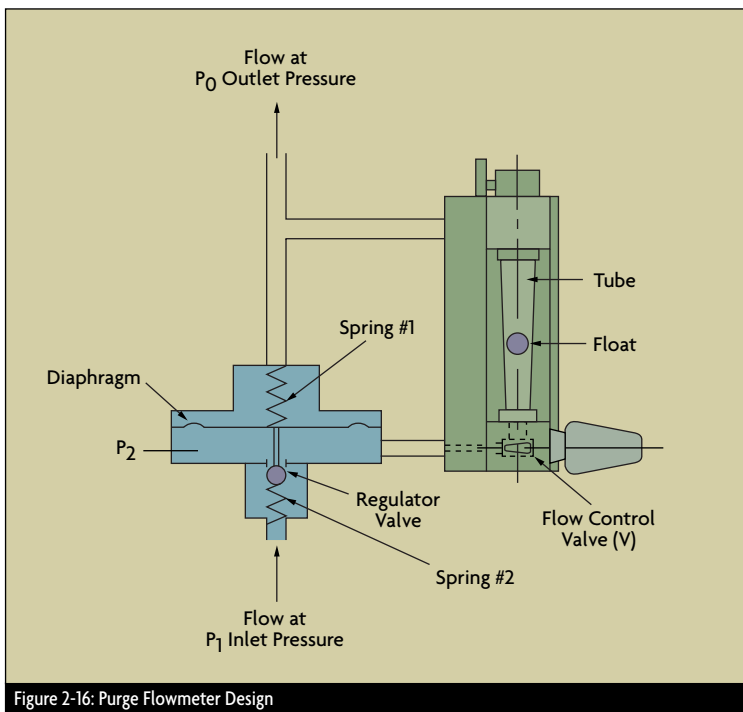

Figure 2-16: Purge Flowmeter Design

spaces of tanks and other equipment. Purging with nitrogen gas reduces the possibility of developing a flammable mixture because it displaces flammable gases. The purge-flow regulator is reliable, intrinsically safe, and inexpensive.

As shown in Figure 2-16, purge meters can operate in the constant flow mode, where  $P_2 - P_0$  is held constant at about 60 to 80 in  $H_2O$  differential. In bubbler and purge applications, the inlet pressure ( $P_1$ ) is held constant and the outlet pressure ( $P_0$ ) is variable. Figure 2-16 describes a configuration where the outlet pressure ( $P_0$ ) is held constant

(0.2-2.0 lpm) on water or 0.2-2.0 scfm (0.3-3.0 cmph) in air service. Typical accuracy is  $\pm 5\%$  FS over a 10:1 range, and the most common pressure rating is 150 psig (1 MPa).

• Rotameters

The rotameter is the most widely used variable area flowmeter because of its low cost, simplicity, low pressure drop, relatively wide rangeability, and linear output. Its operation is simple: in order to pass through the tapered tube, the fluid flow raises the float. The greater the flow, the higher the float is lifted. In liquid service, the float rises due to a

actual flow to a standard flow. For liquids, this standard flow is the water equivalent in gpm; for gases, the standard flow is the air flow equivalent in standard cubic feet per minute (scfm). Tables listing standard water equivalent gpm and/or air scfm values are provided by rotameter manufacturers. Manufacturers also often provide slide rules, nomographs, or computer software for rotameter sizing.

• **Design Variations**

A wide choice of materials is available for floats, packing, O-rings, and end fittings. Rotameter tubes for such safe applications as air or water can be made of glass, whereas if breakage would create an unsafe condition, they are provided with metal tubes. Glass tubes are most common, being precision formed of safety shielded

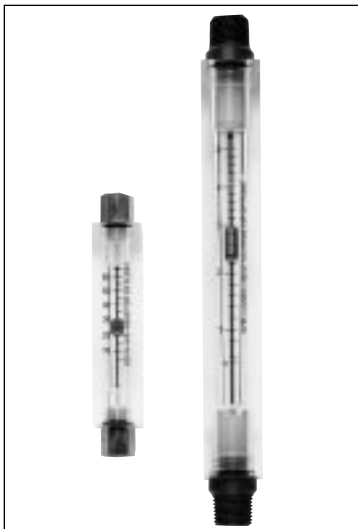

Rotameters can be specified in a wide range of sizes and materials.

borosilicate glass. Floats typically are machined from glass, plastic, metal, or stainless steel for corrosion resistance. Other float materials include carboloy, sapphire, and tantalum. End fittings are available in metal or plas-

tic. Some fluids attack the glass metering tube, such as wet steam or high-pH water over 194°F (which can soften glass); caustic soda (which dissolves glass); and hydrofluoric acid (which etches glass).

Floats have a sharp edge at the point where the reading should be observed on the tube-mounted scale. For improved reading accuracy, a glass-tube rotameter should be installed at eye level. The scale can be calibrated for direct reading of air or water, or can read percentage of range. In general, glass tube rotameters can measure flows up to about 60 gpm water and 200 scfh air.

A correlation rotameter has a scale from which a reading is taken (Figure 2-15). This reading is then compared to a correlation table for a given gas or liquid to get the actual flow in engineering units. Correlation charts are readily available for nitrogen, oxygen, hydrogen, helium, argon, and carbon dioxide. While not nearly as convenient as a direct reading device, a correlation meter is more accurate. This is because a direct-reading device is accurate for only one specific gas or liquid at a particular temperature and pressure. A correlation flowmeter can be used with a wide variety of fluids and gases under various conditions. In the same tube, different flow rates can be handled by using different floats.

Small glass tube rotameters are suitable for working with pressures up to 500 psig, but the maximum operating pressure of a large (2-in diameter) tube may be as low as 100 psig. The practical temperature limit is about 400°F, but such high-temperature operation substantially reduces the operating pressure of the tube. In general, there is a linear relationship between operating temperature and pressure.

Glass-tube rotameters are often used in applications where several streams of gases or liquids are being metered at the same time or mixed in a manifold, or where a single fluid is being exhausted through several channels (Figure 2-17). Multiple tube flowmeters allow up to six rotameters to be mounted in the same frame.

It also is possible to operate a

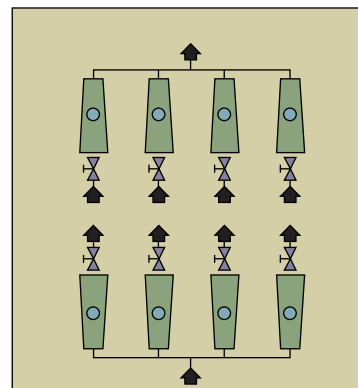

Figure 2-17: Multi-Tube Rotameter Station

rotameter in a vacuum. If the rotameter has a valve, it must be placed at the outlet at the top of the meter. For applications requiring a wide measurement range, a dual-ball rotameter can be used. This instrument has two ball floats: a light ball (typically black) for indicating low flows and a heavy ball (usually white) for indicating high flows. The black ball is read until it goes off scale, and then the white ball is read. One such instrument has a black measuring range from 235-2,350 ml/min and a white to 5,000 ml/min.

For higher pressures and temperatures beyond the practical range of glass, metal tube rotameters can be used. These tubes are usually made of stainless steel, and the position of the float is detected by magnetic followers with readouts outside the metering tube.

Metal-tube rotameters can be



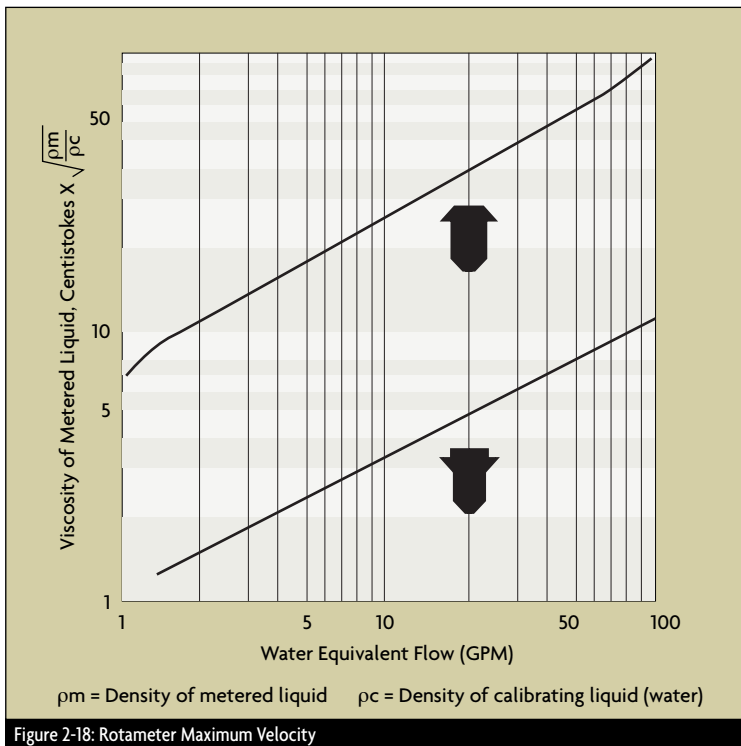

used for hot and strong alkalis, fluorine, hydrofluoric acid, hot water, steam, slurries, sour gas, additives, and molten metals. They also can be used in applications where high operating pressures, water hammer, or other forces could damage glass tubes. Metal-tube rotameters are available in diameter sizes from 3/8 in to 4 in, can operate at pressures up to 750 psig, temperatures to 540°C (1,000°F), and can measure flows up to 4,000 gpm of water or 1,300 scfm of air. Metal-tube rotameters are readily available as flow transmitters for integration with remote analog or digital controls. Transmitters usually detect the float position through magnetic coupling and are often provided with external indication through a rotatable magnetic helix that moves the pointer. The transmitter can be intrinsically safe, micro-processor-based, and can be provided

with alarms and a pulse output for totalization.

Plastic-tube rotameters are relatively low cost rotameters that are ideal for applications involving corrosive fluids or deionized water. The tube itself can be made from Teflon® PFA, polysulfone, or polyamide. The wetted parts can be made from stainless steel, PVDF, or Teflon® PFA, PTFE, PCTFE, with Viton® or Kalrez® O-rings.

• **Accuracy**

Laboratory rotameters can be calibrated to an accuracy of 0.50% AR over a 4:1 range, while the inaccuracy of industrial rotameters is typically 1-2% FS over a 10:1 range. Purge and bypass rotameter errors are in the 5% range.

Rotameters can be used to manually set flow rates by adjusting the valve opening while observing the scale to establish the required process flow rate. If operating conditions

remain unaltered, rotameters can be repeatable to within 0.25% of the actual flow rate.

Most rotameters are relatively insensitive to viscosity variations. The most sensitive are very small rotameters with ball floats, while larger rotameters are less sensitive to viscosity effects. The limitations of each design are published by the manufacturer (Figure 2-18). The float shape does affect the viscosity limit. If the viscosity limit is exceeded, the indicated flow must be corrected for viscosity.

Because the float is sensitive to changes in fluid density, a rotameter can be furnished with two floats (one sensitive to density, the other to velocity) and used to approximate the mass flow rate. The more closely the float density matches the fluid density, the greater the effect of a fluid density change will be on the float position. Mass-flow rotameters work best with low viscosity fluids such as raw sugar juice, gasoline, jet fuel, and light hydrocarbons.

Rotameter accuracy is not affected by the upstream piping configuration. The meter also can be installed directly after a pipe elbow without adverse effect on metering accuracy. Rotameters are inherently self cleaning because, as the fluid flows between the tube wall and the float, it produces a scouring action that tends to prevent the buildup of foreign matter. Nevertheless, rotameters should be used only on clean fluids which do not coat the float or the tube. Liquids with fibrous materials, abrasives, and large particles should also be avoided.

• **Other Variable-Area Flowmeters**

Major disadvantages of the rotameter are its relatively high cost in larger

sizes and the requirement that it be installed vertically (there may not be enough head room). The cost of a large rotameter installation can be reduced by using an orifice bypass or a pitot tube in combination with a smaller rotameter. The same-size bypass rotameter can be used to measure a variety of flows, with the only difference between applications being the orifice plate and the differential it produces.

Advantages of a bypass rotameter include low cost; its major disadvantage is inaccuracy and sensitivity to material build-up. Bypass rotameters are often provided with isolation valves so that they can be removed for maintenance without shutting down the process line.

Tapered plug flowmeters are variable-area flowmeters with a stationary core and a piston that moves as the flow varies. In one design, the piston movement mechanically moves a pointer, while in another it magnetically moves an external flow rate indicator. The second design has a metallic meter body for applications up to 1,000 psig.

One gate-type variable-area flow-meter resembles a butterfly valve. Flow through the meter forces a spring-loaded vane to rotate, and a mechanical connection provides local flow rate indica-

tion. The inaccuracy of such meters is 2-5% FS. The meter can be used on oil, water and air, and is available in sizes up to 4 inches. It also is used as an indicating flow switch in safety interlock systems. 

### References & Further Reading

- OMEGA *Complete Flow and Level Measurement Handbook and Encyclopedia*®, OMEGA Press, 1995.
- OMEGA *Volume 29 Handbook & Encyclopedia, Purchasing Agents Edition*, OMEGA Press, 1995.
- "Choices Abound in Flow Measurement", D. Ginesi, *Chemical Engineering*, April 1991.
- "Developments in DP Flowmeters," Jesse Yoder, *Control*, April 1998.
- *Differential Producers - Orifice, Nozzle, Venturi*, ANSI/ASME MFC, December 1983.
- *Flow Measurement Engineers' Handbook*, R.W. Miller, McGraw-Hill, 1996.
- *Flow Measurement*, D.W. Spitzer, Instrument Society of America, 1991.
- *Flow of Water Through Orifices*, AGA/ASME, Ohio State Univ. Bulletin 89, Vol. IV, No. 3.
- *Fluid Meters*, H.S. Bean, American Society of Mechanical Engineers, 1971.
- *Fundamentals of Flow Measurement*, J. P. DeCarlo, Instrument Society of America, 1984.
- *Instrument Engineers Handbook, 3rd edition*, Bela Liptak, CRC Press, 1995.
- "Orifice Metering of Natural Gas", AGA Report 3, 1985.
- "Primary Element Solves Difficult Flow Metering Problems at Water Waste Treatment Plant," D. Ginesi, L. Keefe, and P. Miller, Proceedings of ISA 1989, Instrument Society of America, 1989.

- Positive Displacement Flowmeters
- Turbine Flowmeters
- Other Rotary Flowmeters

# Mechanical Flowmeters

Discussed in this chapter are various types of mechanical flowmeters that measure flow using an arrangement of moving parts, either by passing isolated, known volumes of a fluid through a series of gears or chambers (positive displacement, or PD) or by means of a spinning turbine or rotor.

All positive displacement flowmeters operate by isolating and counting known volumes of a fluid (gas or liquid) while feeding it through the meter. By counting the number of passed isolated volumes, a flow measurement is obtained. Each PD design uses a different means of isolating and counting these volumes. The frequency of the resulting pulse train is a measure of flow rate, while the total number of pulses gives the size of the batch. While PD meters are operated by the kinetic energy of the flowing fluid, metering pumps (described only briefly in this article) determine the flow rate

angles to the flow, suspended in the fluid stream on a free-running bearing. The diameter of the rotor is very close to the inside diameter of the metering chamber, and its speed of rotation is proportional to the volumetric flow rate. Turbine rotation can be detected by solid state devices or by mechanical sensors. Other types of rotary element flowmeters include the propeller (impeller), shunt, and paddle-wheel designs.

## Positive Displacement Flowmeters

Positive displacement meters provide high accuracy ( $\pm 0.1\%$  of actual flow rate in some cases) and good repeatability (as high as 0.05% of reading). Accuracy is not affected by pulsating flow unless it entrains air or gas in the fluid. PD meters do not require a power supply for their operation and do not require straight upstream and downstream pipe runs for their installation. PD meters are available in sizes from  $\frac{1}{4}$  in to 12 in and can operate

is reduced and metering accuracy is therefore increased as the viscosity of the process fluid increases.

The process fluid must be clean. Particles greater than 100 microns in size must be removed by filtering. PD meters operate with small clearances between their precision-machined parts; wear rapidly destroys their accuracy. For this reason, PD meters are generally not recommended for measuring slurries or abrasive fluids. In clean fluid services, however, their precision and wide rangeability make them ideal for custody transfer and batch charging. They are most widely used as household water meters. Millions of such units are produced annually at a unit cost of less than \$50 U.S. In industrial and petrochemical applications, PD meters are commonly used for batch charging of both liquids and gases.

Although slippage through the PD meter decreases (that is, accuracy increases) as fluid viscosity increases,

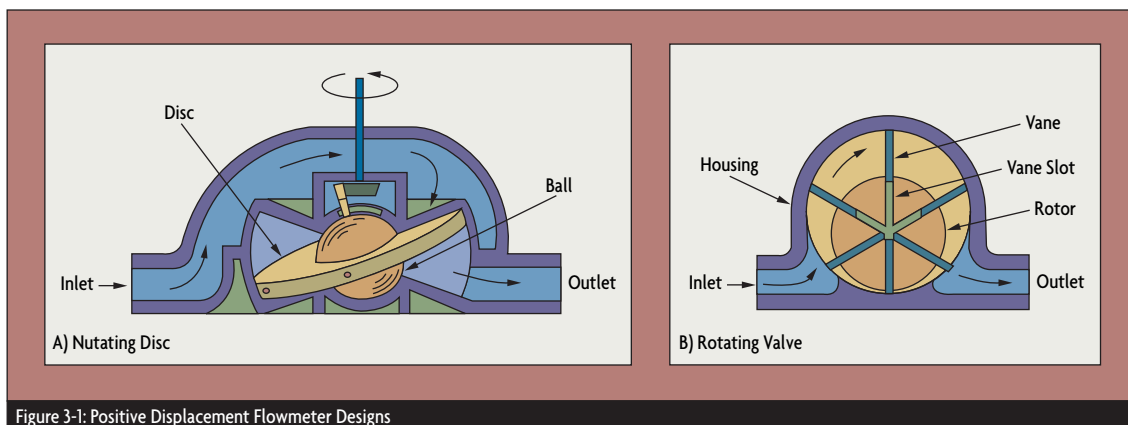

Figure 3-1: Positive Displacement Flowmeter Designs

while also adding kinetic energy to the fluid.

The turbine flowmeter consists of a multi-bladed rotor mounted at right

with turndowns as high as 100:1, although ranges of 15:1 or lower are much more common. Slippage between the flowmeter components

pressure drop through the meter also rises. Consequently, the maximum (and minimum) flow capacity of the flowmeter is decreased as viscosity

increases. The higher the viscosity, the less slippage and the lower the measurable flow rate becomes. As viscosity decreases, the low flow

Because it must be nonmagnetic, the meter housing is usually made of bronze but can be made from plastic for corrosion resistance or cost

of these meters is required to be  $\pm 2\%$  of actual flow rate. Higher viscosity can produce higher accuracy, while lower viscosity and wear over

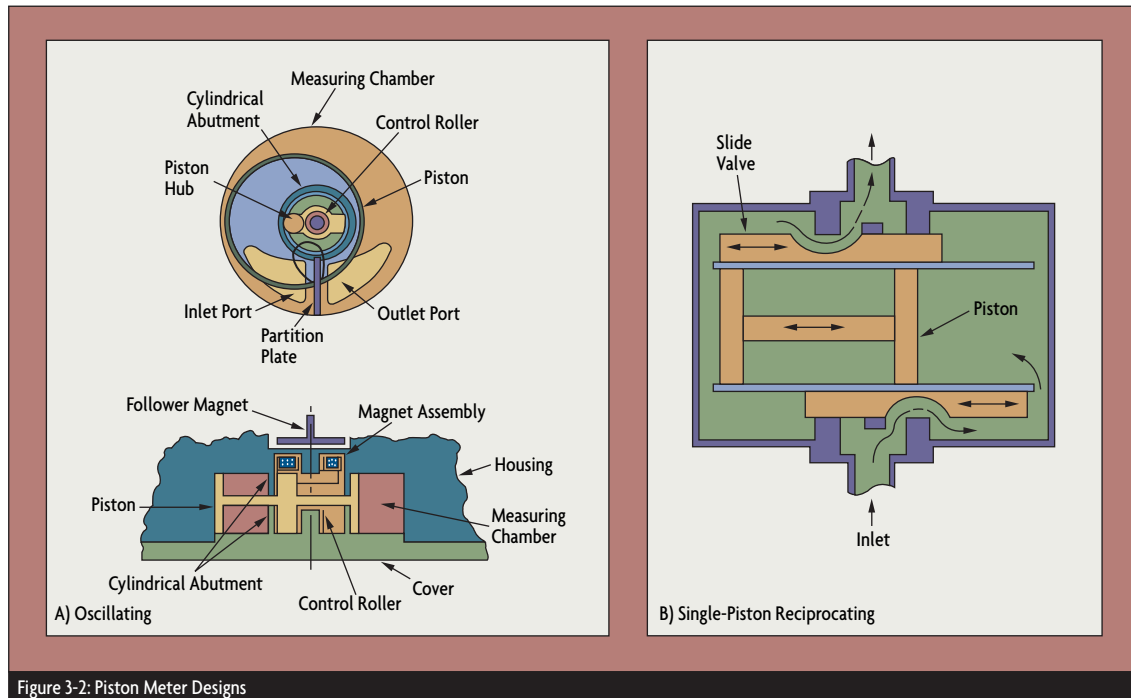

Figure 3-2: Piston Meter Designs

performance of the meter deteriorates. The maximum allowable pressure drop across the meter constrains the maximum operating flow in high viscosity services.

• **Liquid PD Meters**

Nutating disc meters are the most common PD meters. They are used as residential water meters around the world. As water flows through the metering chamber, it causes a disc to wobble (nutate), turning a spindle, which rotates a magnet. This magnet is coupled to a mechanical register or a pulse transmitter. Because the flowmeter entraps a fixed quantity of fluid each time the spindle is rotated, the rate of flow is proportional to the rotational velocity of the spindle (Figure 3-1A).

savings. The wetted parts such as the disc and spindle are usually bronze, rubber, aluminum, neoprene, Buna-N, or a fluoroelastomer such as Viton®. Nutating disc meters are designed for water service and the materials of which they are made must be checked for compatibility with other fluids. Meters with rubber discs give better accuracy than metal discs due to the better sealing they provide.

Nutating disc meters are available in 5/8-in to 2-in sizes. They are suited for 150-psig operating pressures with overpressure to a maximum of 300 psig. Cold water service units are temperature-limited to 120°F. Hot water units are available up to 250°F.

These meters must meet American Water Works Association (AWWA) standards for accuracy. The accuracy

time will reduce accuracy. The AWWA requires that residential water meters be re-calibrated every 10 years. Because of the intermittent use patterns of residential users, this corresponds to recalibrating 5/8 x 3/4 in residential water meters after they have metered 5 million gallons. In industrial applications, however, these meters are likely to pass this threshold much sooner. The maximum continuous flow of a nutating disc meter is usually about 60-80% of the maximum flow in intermittent service.

Rotating vane meters (Figure 3-1B) have spring-loaded vanes that entrap increments of liquid between the eccentrically mounted rotor and the casing. The rotation of the vanes moves the flow increment from inlet to outlet and discharge. Accuracy of

±0.1% of actual rate (AR) is normal, and larger size meters on higher viscosity services can achieve accuracy to within 0.05% of rate.

Rotating vane meters are regularly

large particle size or abrasive solids.

The measurement chamber is cylindrical with a partition plate separating its inlet port from its outlet. The piston is also cylindrical and is

are rated to 1,500 psig. They can meter flow rates from 1 gpm to 65 gpm in continuous service with intermittent excursions to 100 gpm. Meters are sized so that pressure drop is below

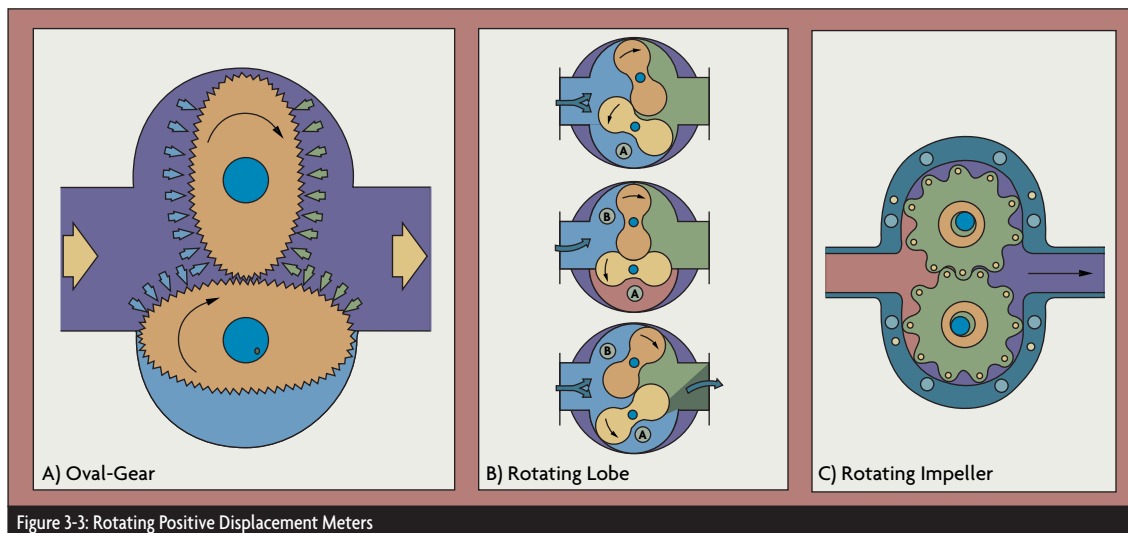

Figure 3-3: Rotating Positive Displacement Meters

used in the petroleum industry and are capable of metering solids-laden crude oils at flow rates as high as 17,500 gpm. Pressure and temperature limits depend on the materials of construction and can be as high as 350°F and 1,000 psig. Viscosity limits are 1 to 25,000 centipoise.

In the rotary displacement meter, a fluted central rotor operates in constant relationship with two wiper rotors in a six-phase cycle. Its applications and features are similar to those of the rotary vane meter.

• **Piston Meters**

Oscillating piston flowmeters typically are used in viscous fluid services such as oil metering on engine test stands where turndown is not critical (Figure 3-2). These meters also can be used on residential water service and can pass limited quantities of dirt, such as pipe scale and fine (*viz.*, -200 mesh or -74 micron) sand, but not

punctured by numerous openings to allow free flow on both sides of the piston and the post (Figure 3-2A). The piston is guided by a control roller within the measuring chamber, and the motion of the piston is transferred to a follower magnet which is external to the flowstream. The follower magnet can be used to drive either a transmitter, a register, or both. The motion of the piston is oscillatory (not rotary) since it is constrained to move in one plane. The rate of flow is proportional to the rate of oscillation of the piston.

The internals of this flowmeter can be removed without disconnection of the meter from the pipeline. Because of the close tolerances required to seal the piston and to reduce slippage, these meters require regular maintenance. Oscillating piston flow meters are available in 1/2-in to 3-in sizes, and can generally be used between 100 and 150 psig. Some industrial versions

35 psid at maximum flow rate. Accuracy ranges from ±0.5 % AR for viscous fluids to ±2% AR for nonviscous applications. Upper limit on viscosity is 10,000 centipoise.

Reciprocating piston meters are probably the oldest PD meter designs. They are available with multiple pistons, double-acting pistons, or rotary pistons. As in a reciprocating piston engine, fluid is drawn into one piston chamber as it is discharged from the opposed piston in the meter. Typically, either a crankshaft or a horizontal slide is used to control the opening and closing of the proper orifices in the meter. These meters are usually smaller (available in sizes down to 1/10-in diameter) and are used for measuring very low flows of viscous liquids.

• **Gear & Lobe Meters**

The oval gear PD meter uses two fine-toothed gears, one mounted

horizontally, the other vertically, with gears meshing at the tip of the vertical gear and the center of the horizontal gear (Figure 3-3A). The two rotors rotate opposite to each other, creating an entrapment in the crescent-shaped gap between the housing and the gear. These meters can be very accurate if slippage between the housing and the gears is kept small. If the process fluid viscosity is greater than 10 centipoise and the flowrate is above 20% of rated capacity, accuracy of 0.1% AR can be obtained. At lower flows and at lower viscosity, slippage increases and accuracy decreases to 0.5% AR or less.

The lubricating characteristics of the process fluid also affect the turn-down of an oval gear meter. With liquids that do not lubricate well, maximum rotor speed must be derated to limit wear. Another way to limit wear is to keep the pressure drop across the meter below 15 psid. Therefore, the pressure drop across the meter limits the allowable maximum flow in high viscosity service.

Rotating lobe and impeller type PD meters are variations of the oval gear flowmeter that do not share its precise gearing. In the rotating lobe design, two impellers rotate in opposite directions within the ovoid housing (Figure 3-3B). As they rotate, a fixed volume of liquid is entrapped and then transported toward the outlet. Because the lobe gears remain in a fixed relative position, it is only necessary to measure the rotational velocity of one of them. The impeller is either geared to a register or is magnetically coupled to a transmitter. Lobe meters can be furnished in 2-in to 24-in line sizes. Flow capacity is 8-10 gpm to 18,000 gpm in the larger sizes. They provide good repeatability (better than 0.015% AR)

at high flows and can be used at high operating pressures (to 1,200 psig) and temperatures (to 400°F).

The lobe gear meter is available in a wide range of materials of construction, from thermoplastics to highly corrosion-resistant metals. Disadvantages of this design include a loss of accuracy at low flows. Also, the maximum flow through this meter is less than for the same size oscillatory piston or nutating disc meter.

In the rotating impeller meter, very coarse gears entrap the fluid and pass a fixed volume of fluid with each rotation (Figure 3-3C). These meters are accurate to 0.5% of rate if the viscosity of the process fluid is both high and constant, or varies only within a narrow band. These meters can be made out of a variety of metals, including stainless steel, and corrosion-resistant plastics such as PVDF (Kynar). These meters are used to meter paints and, because they are available in 3A or sanitary designs, also

rotating impellers is sensed by proximity switches (usually Hall-effect detectors) mounted external to the flow chamber. The sensor transmits a pulse train to a counter or flow controller. These meters are available in 1/10-in to 6-in sizes and can handle pressures to 3,000 psig and temperatures to 400°F.

• **Helix Meters**

The helix meter is a positive displacement device that uses two radially pitched helical gears to continuously entrap the process fluid as it flows. The flow forces the helical gears to rotate in the plane of the pipeline. Optical or magnetic sensors are used to encode a pulse train proportional to the rotational speed of the helical gears. The forces required to make the helices rotate are relatively small and therefore, in comparison to other PD meters, the pressure drop is relatively low. The best attainable accuracy is about ±0.2% or rate.

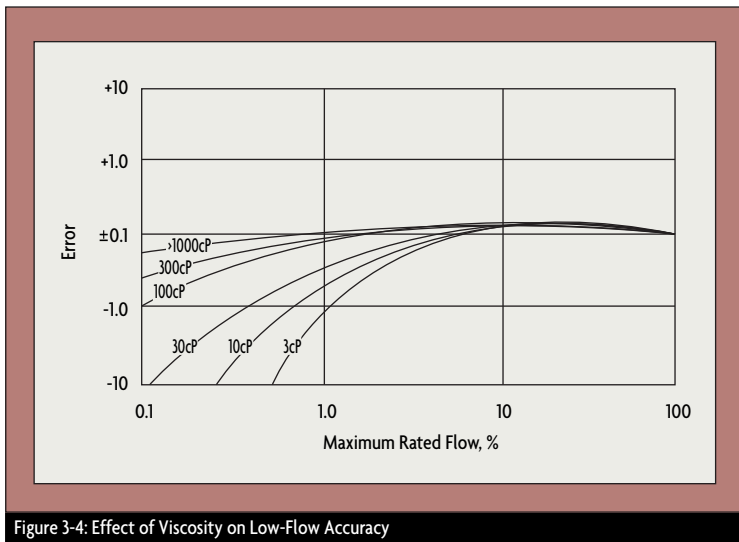

Figure 3-4: Effect of Viscosity on Low-Flow Accuracy

milk, juices, and chocolate.

In these units, the passage of magnets embedded in the lobes of the

As shown in Figure 3-4, measurement error rises as either the operating flowrate or the viscosity of the



process fluid drops. Helical gear meters can measure the flow of highly viscous fluids (from 3 to 300,000 cP), making them ideal for extremely

which also serves to position the tubing. This type of metering pump is used in laboratories, in a variety of medical applications, in the majority of envi-

and the required flow rate and discharge pressure. Check valves (or, on critical applications, double check valves) are selected to protect

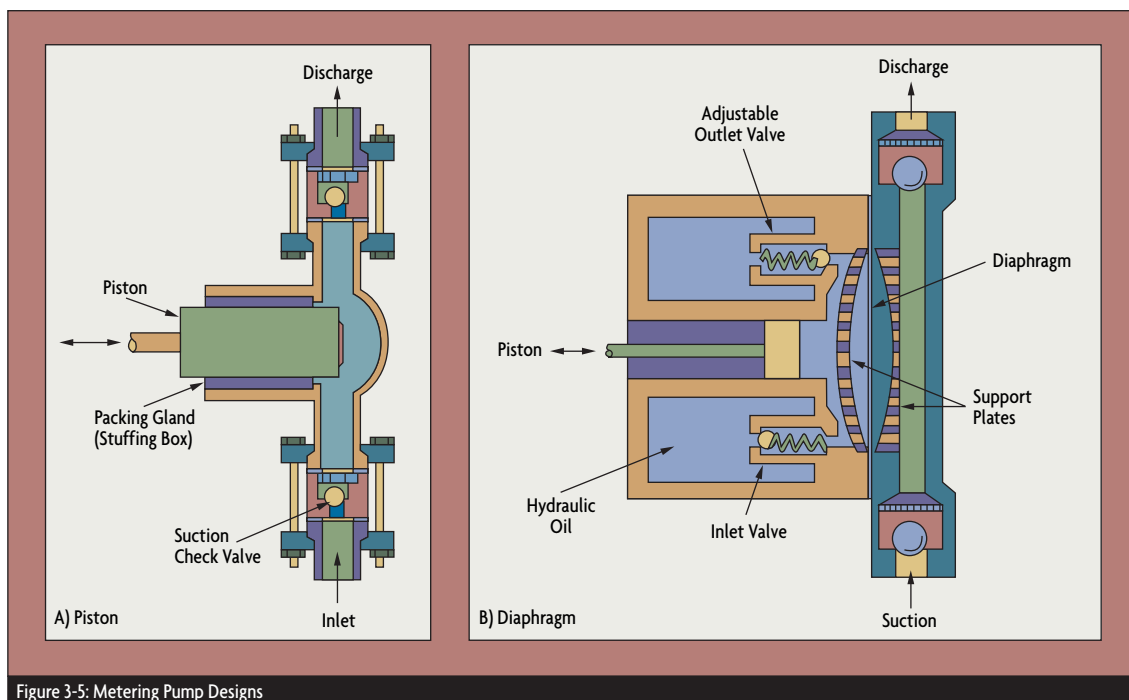

Figure 3-5: Metering Pump Designs

thick fluids such as glues and very viscous polymers. Because at maximum flow the pressure drop through the meter should not exceed 30 psid, the maximum rated flow through the meter is reduced as the fluid viscosity increases. If the process fluid has good lubricating characteristics, the meter turndown can be as high as 100:1, but lower (10:1) turndowns are more typical.

• **Metering Pumps**

Metering pumps are PD meters that also impart kinetic energy to the process fluid. There are three basic designs: peristaltic, piston, and diaphragm.

Peristaltic pumps operate by having fingers or a cam systematically squeeze a plastic tubing against the housing,

ronmental sampling systems, and also in dispensing hypochlorite solutions. The tubing can be silicone-rubber or, if a more corrosion-resistant material is desired, PTFE tubing.

Piston pumps deliver a fixed volume of liquid with each “out” stroke and a fixed volume enters the chamber on each “in” stroke (Figure 3-5A). Check valves keep the fluid flow from reversing. As with all positive displacement pumps, piston pumps generate a pulsating flow. To minimize the pulsation, multiple pistons or pulsation-dampening reservoirs are installed. Because of the close tolerances of the piston and cylinder sleeve, a flushing mechanism must be provided in abrasive applications. Piston pumps are sized on the basis of the displacement of the piston

against backflow.

Diaphragm pumps are the most common industrial PD pumps (Figure 3-5B). A typical configuration consists of a single diaphragm, a chamber, and suction and discharge check valves to prevent backflow. The piston can either be directly coupled to the diaphragm or can force a hydraulic oil to drive the diaphragm. Maximum output pressure is about 125 psig. Variations include bellows-type diaphragms, hydraulically actuated double diaphragms, and air-operated, reciprocating double-diaphragms.

• **Gas PD Meters**

PD gas meters operate by counting the number of entrapped volumes of gas passed, similar to the way PD meters operate on liquids. The

primary difference is that gases are compressible.

Diaphragm gas meters most often are used to measure the flow of natural gas, especially in metering consumption by households. The meter is constructed from aluminum castings with cloth-backed rubber diaphragms. The meter consists of four chambers: the two diaphragm chambers on the inlet and outlet sides and the inlet and outlet chambers of the meter body. The passage of gas through the meter creates a differential pressure between the two diaphragm chambers by compressing the one on the inlet side and expanding the one on the outlet side. This action alternately empties and fills the four chambers. The slide valves at the top of the meter alternate the roles of the chambers and synchronize the action of the diaphragms, as

calibrated for natural gas, which has a specific gravity of 0.6 (relative to air). Therefore, it is necessary to re-calibrate the flow rating of the meter when it is used to meter other gases. The calibration for the new flow rating ( $Q_N$ ) is obtained by multiplying the meter's flow rating for natural gas ( $Q_C$ ) by the square root of the ratio of the specific gravities of natural gas (0.6) and the new gas ( $SG_N$ ):

$$Q_N = Q_C(0.6/SG_N)^{0.5}$$

Diaphragm meters are usually rated in units of cubic feet per hour and sized for a pressure drop of 0.5-2 in  $H_2O$ . Accuracy is roughly  $\pm 1\%$  of reading over a 200:1 range. They maintain their accuracy for long periods of time, which makes them good choices for retail revenue metering applications. Unless the gas is unusually dirty

operate with little or no maintenance indefinitely.

Lobe gear meters (or lobed impeller meters, as they are also known), also are used for gas service. Accuracy in gas service is  $\pm 1\%$  of rate over a 10:1 turndown, and typical pressure drop is 0.1 psid. Because of the close tolerances, upstream filtration is required for dirty lines.

Rotating vane meters measure the flow of gas in the same ranges as do lobe gear meters (up to 100,000  $ft^3/hr$ ) but can be used over a wider 25:1 turndown. They also incur a lower pressure drop of 0.05 in  $H_2O$  for similar accuracy, and, because the clearances are somewhat more forgiving, upstream filtration is not as critical.

• High-Precision PD Systems

High-precision gas meters are usually a hybrid combining a standard PD

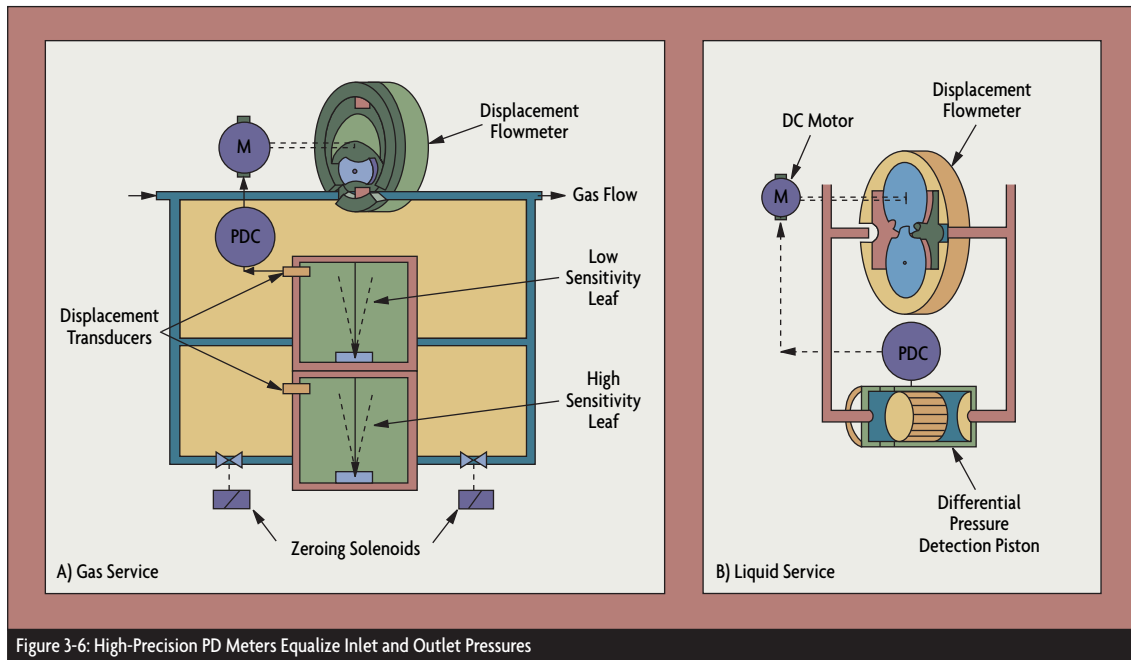

Figure 3-6: High-Precision PD Meters Equalize Inlet and Outlet Pressures

well as operating the crank mechanism for the meter register.

Diaphragm meters generally are

(producer gas, or recycled methane from composting or digesting, for example), the diaphragm meter will

meter and a motor drive that eliminates the pressure drop across the meter. Equalizing the inlet and outlet

pressures eliminates slip flows, leakage, and blow-by. In high-precision gas flowmeter installations, high-sensitivity leaves are used to detect the pressure differential, and displacement transducers are used to measure the deflection of the leaves (Figure 3-6A). Designed to operate at

Vapor separators are usually included, to prevent vapor lock.

• **Testing, Calibration & Provers**

All meters with moving parts require periodic testing, recalibration and repair, because wear increases the clearances. Recalibration can be

Therefore, field-mounted and in-line provers have been developed. This type of prover consists of a calibrated chamber equipped with a barrier piston (Figure 3-7). Two detectors are mounted a known distance (and therefore a known volume) apart. As the flow passes through the chamber, the displacer piston is moved downstream. Dividing the volume of the chamber by the time it takes for the displacer to move from one detector to the other gives the calibrated flow rate. This rate is then compared to the reading of the flowmeter under test.

Provers are repeatable on the order of 0.02%, and can operate at up to 3,000 psig and 165°F/75°C. Their operating flow range is from as low as 0.001 gpm to as high as 20,000 gpm. Provers are available for bench-top use, for mounting in truck-beds, on trailers, or in-line.

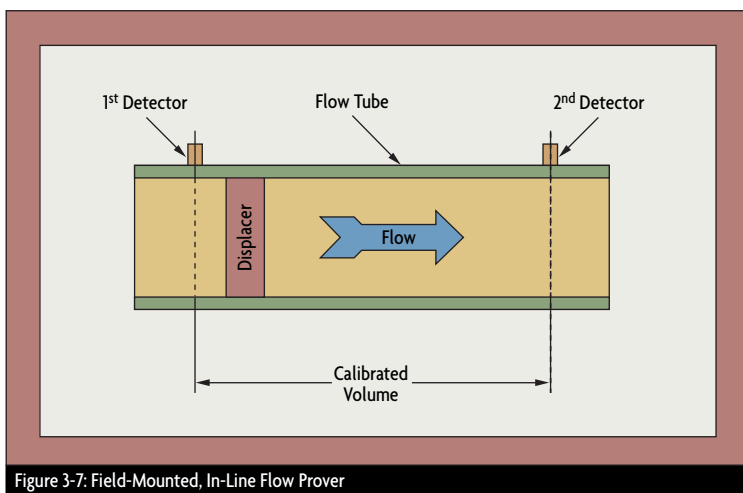

Figure 3-7: Field-Mounted, In-Line Flow Prover

ambient temperatures and at up to 30 psig pressures, this meter is claimed to provide accuracy to within 0.25% of reading over a 50:1 range and 0.5% over a 100:1 range. Flow capacity ranges from 0.3-1,500 scfm.

For liquid service, a servomotor-driven oval-gear meter equalizes the pressure across the meter. This increases accuracy at low flows and under varying viscosity conditions (Figure 3-6B). This flowmeter uses a very sensitive piston to detect the meter differential and drives a variable speed servomotor to keep it near zero. This design is claimed to provide 0.25% of rate accuracy over a 50:1 range at operating pressures of up to 150 psig. High precision flowmeters are used on engine test stands for fuel flow measurement (gasoline, diesel, alcohol, etc.). Flow ranges from 0.04-40 gph are typical.

done either in a laboratory or on line using a prover.

Gas systems are recalibrated against a bell-jar prover—a calibrated cylindrical bell, liquid sealed in a tank. As the bell is lowered, it discharges a known volume of gas through the meter being tested. The volumetric accuracy of bell-jar provers is on the order of 0.1% by volume, and provers are available in discharge volumes of 2, 5, 10 ft<sup>3</sup> and larger.

Liquid systems can be calibrated in the laboratory against either a calibrated secondary standard or a gravimetric flow loop. This approach can provide high accuracy (up to ±0.01% of rate) but requires removing the flowmeter from service.

In many operations, especially in the petroleum industry, it is difficult or impossible to remove a flowmeter from service for calibration.

• **PD Meter Accessories**

PD meter accessories include strainers, filters, air/vapor release assemblies, pulsation dampeners, temperature compensation systems, and a variety of valves to permit dribble cut-off in batching systems. Mechanical registers can be equipped with mechanical or electronic ticket-printers for inventory control and point-of-use sales. Batching flow computers are readily available, as are analog and intelligent digital transmitters. Automatic meter reading (AMR) devices permit the remote retrieval of readings by utility personnel.

**Turbine Flowmeters**

Invented by Reinhard Woltman in the 18th century, the turbine flowmeter is an accurate and reliable flowmeter for both liquids and gases. It consists

of a multi-bladed rotor mounted at right angles to the flow and suspended in the fluid stream on a free-running bearing. The diameter of the rotor is very slightly less than the inside diameter of the metering chamber, and its speed of rotation is proportional to the volumetric flow rate. Turbine rotation can be detected by solid state devices (reluctance, inductance, capacitive and Hall-effect pick-ups) or by mechanical sensors (gear or magnetic drives).

In the reluctance pick-up, the coil is a permanent magnet and the turbine blades are made of a material attracted to magnets. As each blade passes the coil, a voltage is generated

are made of permanently magnetized material (Figure 3-8B). As each blade passes the coil, it generates a voltage pulse. In some designs, only one blade is magnetic and the pulse represents a complete revolution of the rotor.

The outputs of reluctance and inductive pick-up coils are continuous sine waves with the pulse train's frequency proportional to the flow rate. At low flow, the output (the height of the voltage pulse) may be on the order of 20 mV peak-to-peak. It is not advisable to transport such a weak signal over long distances. Therefore, the distance between the pickup and associated display electronics or preamplifier must be short.

they are in the presence of a very low strength (on the order of 25 gauss) magnetic field.

In these turbine flowmeters, very small magnets are embedded in the tips of the rotor blades. Rotors are typically made of a non-magnetic material, like polypropylene, Ryton, or PVDF (Kynar). The signal output from a Hall-effect sensor is a square wave pulse train, at a frequency proportional to the volumetric flowrate.

Because Hall-effect sensors have no magnetic drag, they can operate at lower flow velocities (0.2 ft/sec) than magnetic pick-up designs (0.5-1.0 ft/sec). In addition, the Hall-effect sensor provides a signal of high amplitude

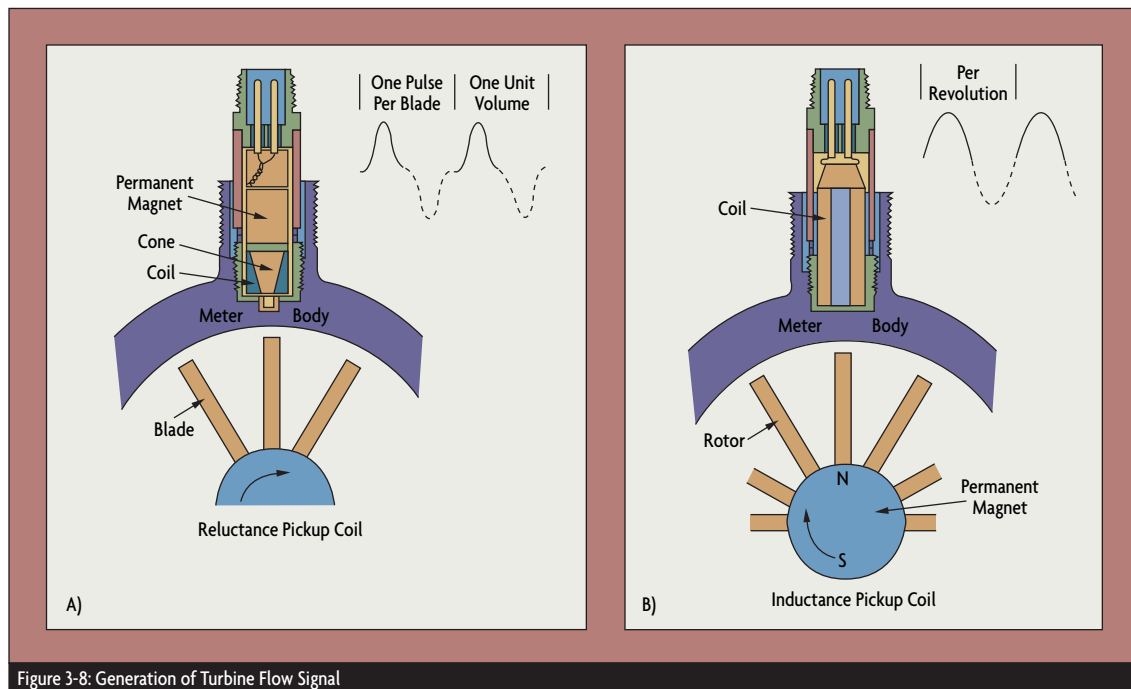

Figure 3-8: Generation of Turbine Flow Signal

in the coil (Figure 3-8A). Each pulse represents a discrete volume of liquid. The number of pulses per unit volume is called the meter's K-factor.

In the inductance pick-up, the permanent magnet is embedded in the rotor, or the blades of the rotor

Capacitive sensors produce a sine wave by generating an RF signal that is amplitude-modulated by the movement of the rotor blades. Instead of pick-up coils, Hall-effect transistors also can be used. These transistors change their state when

(typically a 10.8-V square wave), permitting distances up to 3,000 ft. between the sensor and the electronics without amplification.

In the water distribution industry, mechanical-drive Woltman-type turbine flowmeters continue to be the

standard. These turbine meters use a gear train to convert the rotation of the rotor into the rotation of a vertical shaft. The shaft passes between the metering tube and the register section through a mechanical stuff-

turbine meters must register between 98-102% of actual rate at maximum flow when tested. Class II turbine meters must register between 98.5-101.5% of actual rate. Both Class I and Class II meters must

whereas turbine meters intended for municipal water service are bronze or cast iron. The rotor and bearing materials are selected to match the process fluid and the service. Rotors are often made from stainless steel, and bearings of graphite, tungsten carbide, ceramics, or in special cases of synthetic ruby or sapphire combined with tungsten carbide. In all cases, bearings and shafts are designed to provide minimum friction and maximum resistance to wear. Some corrosion-resistant designs are made from plastic materials such as PVC.

Small turbine meters often are called barstock turbines because in sizes of 3/4 in to 3 in. they are machined from stainless steel hexagonal barstock. The turbine is suspended by a bearing between two hanger assemblies that also serve to condition the flow. This design is suited for high operating pressures (up to 5,000 psig).

Similar to a pitot tube differential pressure flowmeter, the insertion turbine meter is a point-velocity device. It is designed to be inserted into either a liquid or a gas line to a depth at which the small-diameter rotor will read the average velocity in the line.

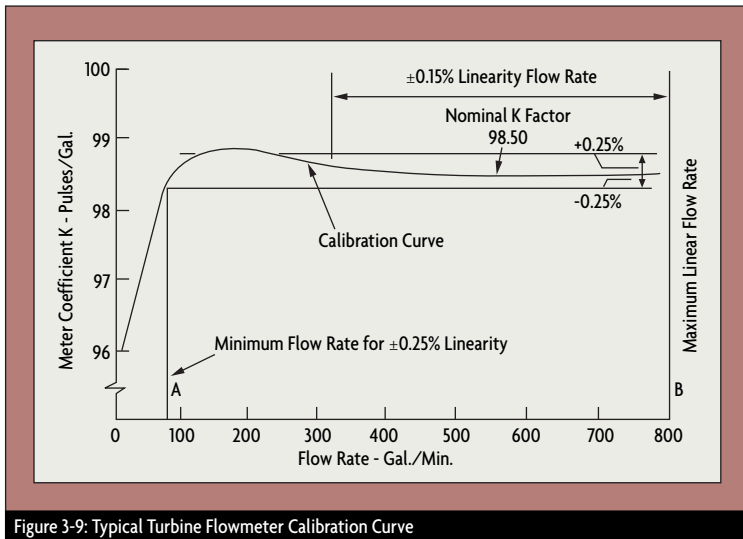

Figure 3-9: Typical Turbine Flowmeter Calibration Curve

ing box, turning a geared mechanical register assembly to indicate flow rate and actuate a mechanical totalizer counter.

More recently, the water distribution industry has adopted a magnetic drive as an improvement over high maintenance mechanical-drive turbine meters. This type of meter has a sealing disc between the measuring chamber and the register. On the measuring chamber side, the vertical shaft turns a magnet instead of a gear. On the register side, an opposing magnet is mounted to turn the gear. This permits a completely sealed register to be used with a mechanical drive mechanism.

In the United States, the AWWA sets the standards for turbine flowmeters used in water distribution systems. Standard C701 provides for two classes (Class I and Class II) of turbine flowmeters. Class I

have mechanical registers.

Solid state pickup designs are less susceptible to mechanical wear than AWWA Class I and Class II meters.

• **Design & Construction Variations**

Most industrial turbine flowmeters are manufactured from austenitic stainless steel (301, 303, 304SS),



This innovative turbine meter trades out a transmitted signal for local LCD indication.

Because they are very sensitive to the velocity profile of the flowing stream, they must be profiled at several points across the flow path.

Insertion turbine meters can be designed for gas applications (small, lightweight rotor) or for liquid (larger rotor, water-lubricated bearings). They are often used in large diameter pipelines where it would be cost-prohibitive to install a full size meter. They can be hot-tapped into existing

bility is from  $\pm 0.2\%$  to  $\pm 0.02\%$  over the linear range.

Because there are minor inconsistencies in the manufacturing process, all turbine flowmeters are calibrated prior to shipment. The resulting K-factor in pulses per volume unit will vary within the stated linearity specification. It is possible, however, to register several K-factors for different portions of the flow range and to electronically switch

downs if accuracy is de-rated to 1% of full scale (FS).

• **Sizing & Selection**

Turbine meters should be sized so that the expected average flow is between 60% and 75% of the maximum capacity of the meter. If the pipe is oversized (with flow velocity under 1 ft/sec), one should select a Hall-effect pick-up and use a meter smaller than the line size. Flow velocities

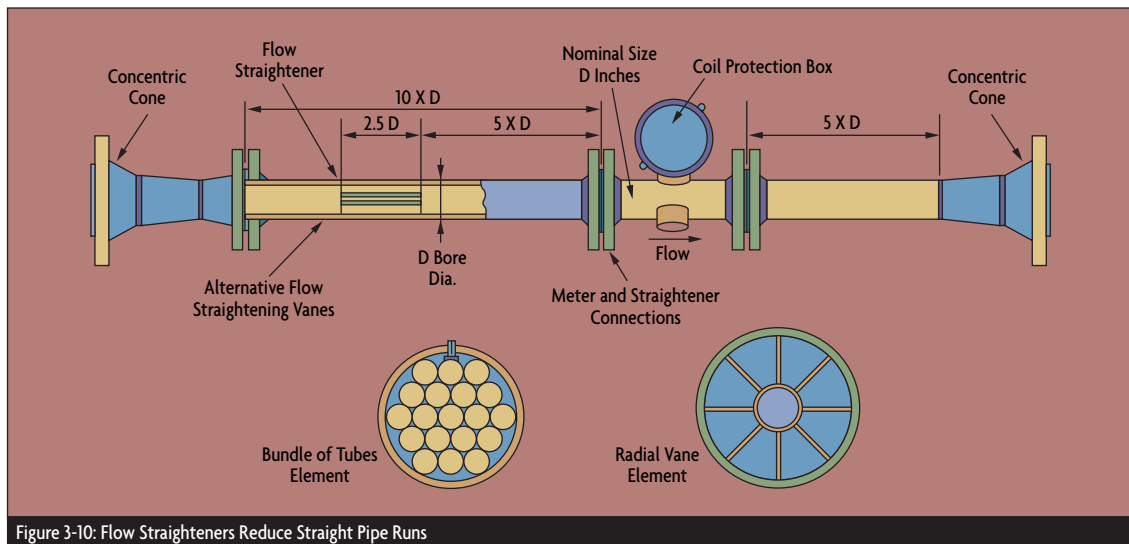

Figure 3-10: Flow Straighteners Reduce Straight Pipe Runs

pipelines (6 in or larger) through a valving system without shutting down the process. Typical accuracy of an insertion turbine meter is 1% FS, and the minimum flow velocity is about 0.2 ft/sec.

• **Turbine Meter Accuracy**

Figure 3-9 shows a typical turbine-meter calibration curve describing the relationship between flow and K-factor (pulses/gallon). The accuracy of turbine meters is typically given in percentage of actual rate (% AR). This particular meter has a linearity tolerance band of  $\pm 0.25\%$  over a 10:1 flow range and a  $\pm 0.15\%$  linearity in a 6:1 range. The repeatability

from one to the other as the measured flow changes. Naturally, the K-factor is applicable only to the fluid for which the meter was calibrated.

Barstock turbine meters typically are linear to  $\pm 0.25\%$  AR over a 10:1 flow range. The linearity of larger meters is  $\pm 0.5\%$  AR over a 10:1 flow range. Turbine meters have a typical nonlinearity (the turbine meter hump, shown in Figure 3-9) in the lower 25-30% of their range. Keeping the minimum flow reading above this region will permit linearity to within 0.15% on small and 0.25% on larger turbine meters. If the range of 10:1 is insufficient, some turbine flowmeters can provide up to 100:1 turn-

under 1 ft/sec can be insufficient, while velocities in excess of 10 ft/sec can result in excessive wear. Most turbine meters are designed for maximum velocities of 30 ft/sec.

Turbine flowmeters should be sized for between 3 and 5 psid pressure drop at maximum flow. Because pressure drop increases with the square of flow rate, reducing the meter to the next smaller size will raise the pressure drop considerably.

Viscosity affects the accuracy and linearity of turbine meters. It is therefore important to calibrate the meter for the specific fluid it is intended to measure. Repeatability is generally not greatly affected by changes in viscosity,



and turbine meters often are used to control the flow of viscous fluids. Generally, turbine meters perform well if the Reynolds Number is greater than 4,000 and less than or equal to 20,000.

- upstream straight-pipe runs
- 20 diameters for 90° elbow, tee, filter, strainer, or thermowell;
  - 25 diameters for a partially open valve; and

Turbine meters also can be damaged by solids entrained in the fluid. If the amount of suspended solids exceeds 100 mg/l of +75 micron size, a flushing y-strainer or a

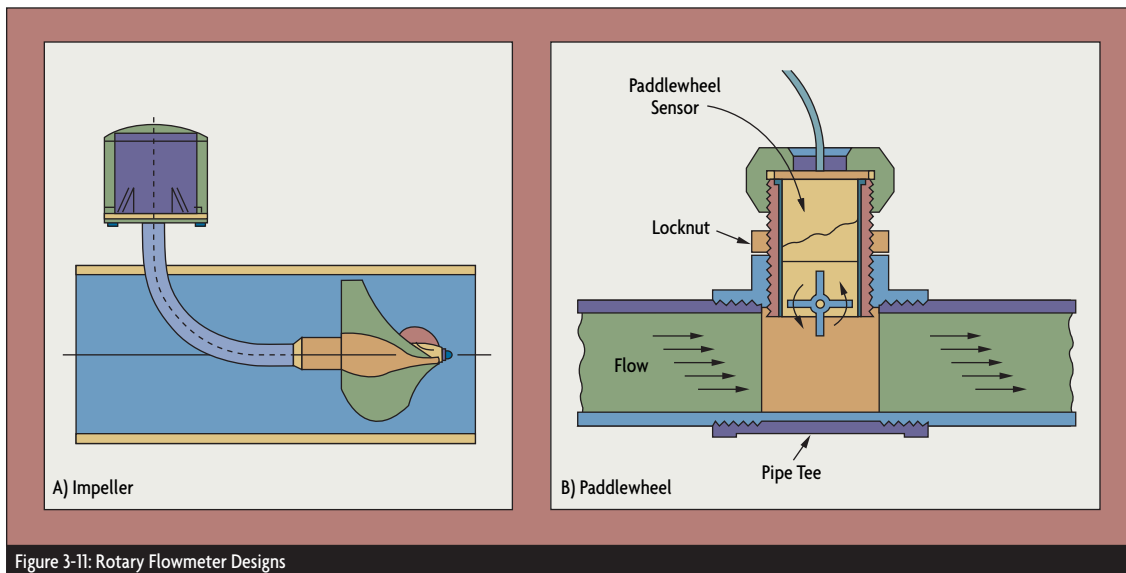

Figure 3-11: Rotary Flowmeter Designs

Because it affects viscosity, temperature variation can also adversely affect accuracy and must be compensated for or controlled. The turbine meter's operating temperature ranges from -200 to 450°C (-328 to 840°F).

Density changes do not greatly affect turbine meters. On low density fluids (SG < 0.7), the minimum flow rate is increased due to the reduced torque, but the meter's accuracy usually is not affected.

• **Installation & Accessories**

Turbine meters are sensitive to upstream piping geometry that can cause vortices and swirling flow. Specifications call for 10-15 diameters of straight run upstream and five diameters of straight run downstream of the meter. However, the presence of any of the following obstructions upstream would necessitate that there be more than 15 diameters of

- 50 or more diameters if there are two elbows in different planes or if the flow is spiraling or corkscrewing.

In order to reduce this straight-run requirement, straightening vanes are installed. Tube bundles or radial vane elements are used as external flow straighteners located at least 5 diameters upstream of the meter (Figure 3-10).

Under certain conditions, the pressure drop across the turbine can cause flashing or cavitation. The first causes the meter to read high, the second results in rotor damage. In order to protect against this, the downstream pressure must be held at a value equaling 1.25 times the vapor pressure plus twice the pressure drop. Small amounts of air entrainment (100 mg/l or less) will make the meter read only a bit high, while large quantities can destroy the rotor.

motorized cartridge filter must be installed at least 20 diameters of straight run upstream of the flowmeter.

• **New Developments**

Dual-rotor liquid turbines increase the operating range in small line size (under 2 in) applications. The two rotors turn in opposite directions. The front one acts as a conditioner, directing the flow to the back rotor. The rotors lock hydraulically and continue to turn as the flow decreases even to very low rates.

The linearity of a turbine meter is affected by the velocity profile (often dictated by the installation), viscosity, and temperature. It is now possible to include complex linearization functions in the preamplifier of a turbine flowmeter to reduce these nonlinearities. In addition, advances in fieldbus technology make it possible

to recalibrate turbine flowmeters continuously, thereby correcting for changes in temperature and viscosity.

Flow computers are capable of linearization, automatic temperature compensation, batching, calculation of BTU content, datalogging, and storage of multiple K-factors. The batching controller is set with the desired target volume and, when its totalizer has counted down to zero, it terminates the batch. Such packages are equipped with dribble flow, pre-warn, or trickle-cut-off circuits. Whether functioning through a relay contact or a ramp function, these features serve to minimize splashing or overflow and to accurately terminate the batch.

• **Gas Turbine & Shunt Meters**

Gas meters compensate for the lower driving torque produced by the relatively low density of gases. This compensation is obtained by very large rotor hubs, very light rotor assemblies, and larger numbers of rotor blades. Gas turbine meters are available from 2" to 12" and with flow ratings up to 150,000 ft<sup>3</sup>/hr. When operating at elevated gas pressures (1,400 psig), a rangeability of 100:1 can be obtained in larger size meters. Under lower pressure conditions, typical rangeability is 20:1 with ±1% linearity. The minimum upstream straight pipe-run requirement is 20 pipe diameters.

Shunt flowmeters are used in gas and steam service. They consist of an orifice in the main line and a rotor assembly in the bypass. These meters are available in sizes 2 in. and larger and are accurate to ±2% over a range of 10:1.

**Other Rotary Flowmeters**

Other types of rotary element flowmeters include propeller (impeller), shunt, and paddlewheel designs.

Propeller meters are commonly used in large diameter (over 4 in) irrigation and water distribution systems. Their primary trade-off is low cost and low accuracy (Figure 3-11A). AWWA Standard C-704 sets the accuracy criterion for propeller meters at 2% of reading. Propeller meters have a rangeability of about 4:1 and exhibit very poor performance if the velocity drops below 1.5 ft/sec. Most propeller meters are equipped with mechanical registers. Mechanical wear, straightening, and conditioning requirements are the same as for turbine meters.

Paddlewheel flowmeters use a rotor whose axis of rotation is parallel to the direction of flow (Figure 3-11B). Most paddlewheel meters have flat-bladed rotors and are inherently bi-directional. Several manufacturers, however, use crooked rotors that only rotate in

the forward direction. For smaller pipes (1/2" to 3"), these meters are available only with a fixed insertion depth, while for larger pipe sizes (4" to 48") adjustable insertion depths are available. The use of capacitively coupled pick-ups or Hall-effect sensors extends the range of paddlewheel meters into the low-flow velocity region of 0.3 ft/sec.

Low-flow meters (usually smaller than 1 in.) have a small jet orifice that projects the fluid onto a Pelton wheel. Varying the diameter and the shape of the jet orifice matches the required flow range and provides a flowmeter that is accurate to 1% FS and has a rangeability of 100:1. Higher accuracy can be achieved by calibrating the meter and by lowering its range. Because of the small size of the jet orifice, these meters can only be used on clean fluids and they incur a pressure drop of about 20 psid. Materials of construction include polypropylene, PVDF, TFE and PFA, brass, aluminum, and stainless steel. T

**References & Further Reading**

- *OMEGA Complete Flow and Level Measurement Handbook and Encyclopedia*®, OMEGA Press, 1995.
- *OMEGA Volume 29 Handbook & Encyclopedia, Purchasing Agents Edition*, OMEGA Press, 1995.
- *Flow Measurement Engineering Handbook*, Miller, McGraw-Hill, 1982.
- *Flow Measurement*, D. W. Spitzer, ISA, 1991.
- *Flowmeters in Water Supply*, Manual M33, AWWA, 1989.
- *Industrial Flow Measurement*, D. W. Spitzer, ISA 1984.
- *Instrument Engineer's Handbook*, Bela Liptak, editor, CRC Press, 1995.
- "Turbine Flowmeter Extends Flow Range", E. Piechota, *Flow Control*, February, 1997.
- *Water Meters—Selection, Installation, Testing and Maintenance*, Manual M6, AWWA, 1986.

- Magnetic Flowmeters
- Vortex Flowmeters
- Ultrasonic Flowmeters

# Electronic Flowmeters

While the flow measurement technologies discussed in this chapter—magnetic, vortex, and ultrasonic—are neither exclusively nor exhaustively electronic in nature, they do represent a logical grouping of flow measurement technologies. All have no moving parts (well, maybe vibrating), are relatively non-intrusive, and are made possible by today's sophisticated electronics technology.

Magnetic flowmeters, for example, are the most directly electrical in nature, deriving their first principles of operation from Faraday's law. Vortex meters depend on piezoelectric sensors to detect vortices shed from a stationary shedder bar. And today's ultrasonic flowmeters owe their successful application to sophisticated digital signal processing.

## Magnetic Flowmeters

The operation of magnetic flowmeters is based on Faraday's law of electromagnetic induction. Magmeters can detect the flow of conductive fluids only. Early magmeter designs required a minimum fluidic conductivity of 1-5 microsiemens per centimeter for their operation. The newer designs have reduced that requirement a hundredfold to between 0.05 and 0.1.

The magnetic flowmeter consists of a non-magnetic pipe lined with an insulating material. A pair of magnetic coils is situated as shown in Figure 4-1, and a pair of electrodes penetrates the pipe and its lining. If a conductive fluid flows through a pipe of diameter (D) through a magnetic field density

(B) generated by the coils, the amount of voltage (E) developed across the electrodes—as predicted by Faraday's law—will be proportional to the velocity (V) of the liquid. Because the magnetic field density and the pipe diameter are fixed values, they can be combined into a calibration factor (K) and the equation reduces to:

$$E = KV$$

The velocity differences at different points of the flow profile are compensated for by a signal-weighting factor. Compensation is also provided by shaping the magnetic coils such that the magnetic flux will be greatest where the signal weighing factor is lowest, and vice versa.

Manufacturers determine each magmeter's K factor by water calibration of each flowtube. The K value thus obtained is valid for any other conductive liquid and is linear over the entire flowmeter range. For this reason, flowtubes are usually calibrated at only one velocity. Magmeters can measure flow in both directions, as reversing direction will change the polarity but not

the magnitude of the signal.

The K value obtained by water testing might not be valid for non-Newtonian fluids (with velocity-dependent viscosity) or magnetic slurries (those containing magnetic particles). These types of fluids can affect the density of the magnetic field in the tube. In-line calibration and special compensating designs should be considered for both of these fluids.

### • Magmeter Excitation

The voltage that develops at the electrodes is a millivolt signal. This signal is typically converted into a standard current (4-20 mA) or frequency output (0-10,000 Hz) at or near the flowtube. Intelligent magnetic transmitters with digital outputs allow direct connection to a distributed control system. Because the magmeter signal is a weak one, the lead wire should be shielded and twisted if the transmitter is remote.

The magmeter's coils can be powered by either alternating or direct current (Figure 4-2). When ac excitation is used, line voltage is applied to

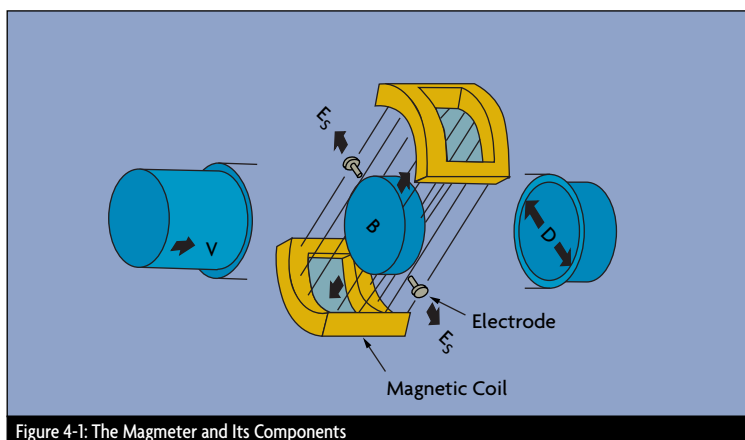

Figure 4-1: The Magmeter and Its Components

the magnetic coils. As a result, the flow signal (at constant flow) will also look like a sine wave. The amplitude of the wave is proportional to velocity. In addition to the flow signal, noise voltages can be induced in the electrode loop. Out-of-phase noise is easily filtered, but in-phase noise requires that the flow be stopped (with the pipe full) and the transmitter output set to zero. The main problem with ac magmeter designs is that noise can vary with process conditions and frequent re-zeroing is required to maintain accuracy.

In dc excitation designs, a low frequency (7-30 Hz) dc pulse is used to excite the magnetic coils. When the coils are pulsed on (Figure 4-2), the transmitter reads both the flow and noise signals. In between pulses, the transmitter sees only the noise signal. Therefore, the noise can be continuously eliminated after each cycle.

This provides a stable zero and eliminates zero drift. In addition to being more accurate and able to measure lower flows, dc meters are less bulky, easier to install, use less energy, and have a lower cost of ownership than ac meters. One new dc design uses significantly more power than the earlier generations and thereby creates a stronger flow-tube signal.

Another new design uses a unique dual excitation scheme that pulses the coils at 7 Hz for zero stability and also at 70 Hz to obtain a stronger signal. Magmeter transmitters can be supplied with either ac or dc power. A two-wire, loop-powered dc magnetic flowmeter is also available in an intrinsically safe design, but its performance is reduced because of power limitations.

Pulsed ac meters have also been introduced recently, eliminating the

zero stability problems of traditional ac designs. These devices contain circuitry that periodically disrupts the ac power, automatically zeroing out the effects of process noise on the output signal.

Today, dc excitation is used in about 85% of installations and ac magmeters claim the other 15% when

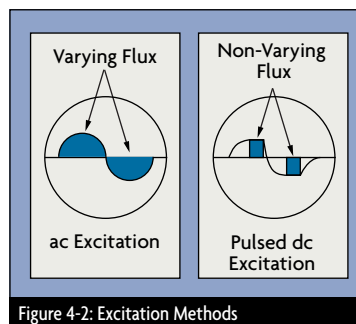

Figure 4-2: Excitation Methods

justified by the following conditions:

- When air is entrained in large quantities in the process stream;
- When the process stream is a slurry and the solid particle sizes are not uniform and/or the solid phase is not homogeneously mixed within the liquid; or
- When the flow is pulsating at a frequency under 15 Hz.

When any of the above three conditions exist, the output of a pulsed dc meter is likely to be noisy. In some cases, one can minimize the noise problem (hold the fluctuations within 1% of setpoint) by filtering and damping the output signal. If more than 1 to 3 seconds of damping is required to eliminate the noise, it is always better to use an ac meter.

#### • Flowtubes, Liners, & Probes

The face-to-face dimensions of flanged flowtubes (lay lengths) usually meet the recommendations of the International Organization for Standardization (ISO). The dimensions of short-form magmeters usually

meet these guidelines as well. Magnetic flowtubes and liners are available in many materials and are widely used in all the process industries, including food, pharmaceutical, mining, and metals.

Some liner materials (particularly Teflon®) can be damaged when pry bars are used while installing it or removing it from process piping. They can also be damaged by over-torquing the flange bolts. Liner protectors are available to help prevent such damage.

Any flowtube can generally be used with any transmitter offered by the same manufacturer. Depending on its construction and features, the cost of a 2-in. magnetic flowmeter can range from \$1,500 to \$5,000. This cost has been coming down, but is still higher than that of the least expensive flow sensors.

Magnetic flowmeters also can be packaged as probes and inserted into process pipes through taps. These probes contain both the electrodes and magnetic coils. The flowing process fluid induces a voltage at the electrodes, which reflects the velocity at the probe tip and not the average fluid velocity across the pipe. These magmeters are inexpensive and retractable. Therefore, the process does not have to be shut down to install or remove them. Metering accuracy is highly dependent on the relationship between the measured velocity and the average velocity in the pipe.

#### • Electrodes

In conventional flowtubes, the electrodes are in contact with the process fluid. They can be removable or permanent if produced by a droplet of liquid platinum as it sinters through a ceramic liner and fuses with the aluminum oxide to form a perfect seal.

This design is preferred due to its low cost, its resistance to abrasion and wear, its insensitivity to nuclear radiation, and its suitability for sanitary applications because there are no cavities in which bacteria can grow. On the other hand, the ceramic tube cannot tolerate bending, tension, or sudden cooling and cannot handle oxidizing acids or hot and concentrated caustic.

the pipe diameter) in order to remain covered by the fluid. Compensation is provided for wave action and calibration is provided for full pipe, no flow (static level), and partially filled pipe operation.

Another recent development is a magnetic flowmeter with an unlined carbon steel flowtube. In this design, the measuring electrodes mount externally to the unlined flowtube

It is important that the conductivity of the process fluid be uniform. If two fluids are mixed and the conductivity of one additive is significantly different from that of the other process fluid, it is important that they be completely intermixed before the blend reaches the magmeter. If the blend is not uniform, the output signal will be noisy. To prevent that, pockets of varying conductivity can

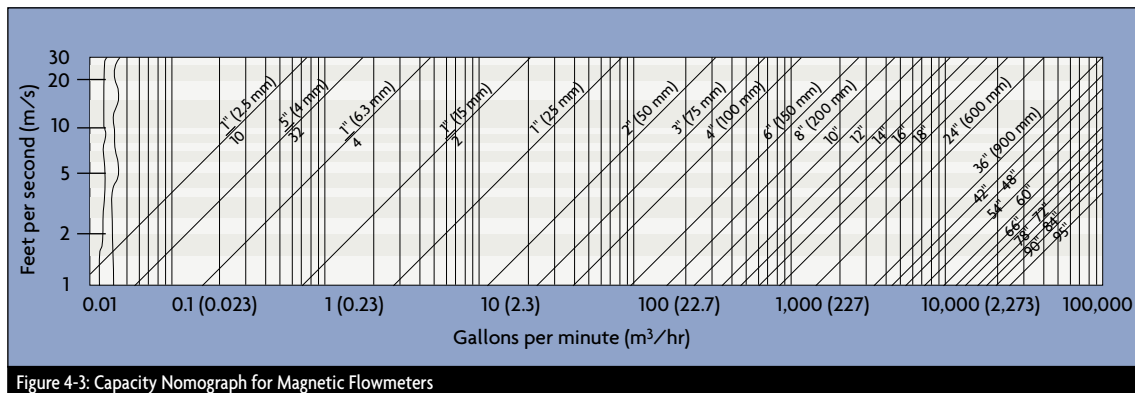

Figure 4-3: Capacity Nomograph for Magnetic Flowmeters

In a more recent capacitively-coupled design, non-contacting electrodes are used. These designs use areas of metal sandwiched between layers of liner material. They are available in sizes under eight inches in diameter and with ceramic liners. Magmeters using these non-contacting electrodes can “read” fluids having 100 times less conductivity than required to actuate conventional flowtubes. Because the electrode is behind the liner, these designs are also better suited for severe coating applications.

• Recent Developments

When a magnetic flowmeter is provided with a capacitance level sensor embedded in the liner, it can also measure the flow in partially full pipes. In this design, the magmeter electrodes are located at the bottom of the tube (at approximately 1/10

and the magnetic coils generate a field 15 times stronger than in a conventional tube. This magnetic field penetrates deep into the process fluid (not just around the electrode as with standard magmeter probes). The main advantage is low initial and replacement costs, since only the sensors need be replaced.

• Selection & Sizing

Magnetic flowmeters can detect the flow of clean, multi-phase, dirty, corrosive, erosive, or viscous liquids and slurries as long as their conductivity exceeds the minimum required for the particular design. The expected inaccuracy and rangeability of the better designs are from 0.2-1% of rate, over a range of 10:1 to 30:1, if the flow velocity exceeds 1 ft/sec. At slower flow velocities (even below 0.1 ft/s), measurement error increases, but the readings remain repeatable.

be eliminated by installing a static mixer upstream of the magmeter.

Magmeter size is determined by capacity tables or charts published by the manufacturer. Figure 4-3 provides a flow capacity nomograph for line sizes from 0.1 in. to 96 in. For most applications, flow velocities should fall between 3 ft/sec and 15 ft/sec. For corrosive fluids, the normal velocity range should be 3-6 ft/sec. If the flowtube is continuously operated below 3 ft/sec, metering accuracy will deteriorate, while continuous operation exceeding the upper limit of the normal velocity range will shorten the life of the meter.

The obstructionless nature of the magmeter lowers the likelihood of plugging and limits the unrecovered head loss to that of an equivalent length of straight pipe. The low pressure drop is desirable because it

lowers pumping costs and aids gravity feed systems.

• **Problem Applications**

The magmeter cannot distinguish entrained air from the process fluid; therefore, air bubbles will cause the magmeter to read high. If the trapped air is not homogeneously dispersed, but takes the form of air slugs or large air bubbles (the size of the electrode), this will make the output signal noisy or even disrupt it. Therefore, in applications where air entrainment is likely, the meter should be sized so that the flow velocity under normal flow conditions is 6-12 ft/sec.

Coating of the electrodes is another common magmeter problem. Material build-up on the inner surfaces of the meter can electrically isolate the electrodes from the process fluid. This can cause a loss of signal or a measurement error, either by changing the diameter of the flowtube or by causing span and zero shifts. Naturally, the best solution is prevention. One preventive step is to size the meter such that, under normal flow conditions, the flowing velocity will be relatively high: at least 6-12 ft/sec, or as high as practical considering the possibility of erosion and corrosion.

Another method of prevention is to use electrodes that protrude into the flow stream to take advantage of the turbulence and washing effect. In more severe service, a mechanical cleaning system can be installed and used intermittently or continuously to eliminate coating and build-ups.

• **Installation**

The magnetic flowmeter must always be full of liquid. Therefore, the preferred location for magmeters is in vertical upward flow lines.

Installation in horizontal lines is acceptable if the pipe section is at a low point and if the electrodes are not at the top of the pipe. This prevents air from coming into contact with the electrodes. When the process fluid is a slurry and the magmeter is installed at a low point, it should be removed during long periods of shutdown, so that solids will not settle and coat the internals.

If it is essential to drain the magmeter periodically, it should be provided with an empty tube zero option. When this option is activated, the output of the transmitter will be clamped to zero. Detection of empty tube conditions is by circuitry connected to extra sets of electrodes in the flowtube. The empty tube zero feature can also be activated by an external contact, such as

liner wear. Liner protectors are available to protect the leading edge of the liners from the abrasive effects of process fluids. If the magmeter is installed in a horizontal pipe exceeding 30 ft in length, the pipe should be supported on both sides of the meter.

The magnetic flowmeter must be electrically grounded to the process liquid. This is because the magmeter is part of the path for any stray current traveling down the pipeline or through the process liquid. Bonding, by grounding the meter at both ends to the process fluid, provides a short circuit for stray currents, routing them around the flowtube instead of through it. If the system is not properly grounded, these currents can create a zero shift in the magnetic flowmeter output.

Electrical bonding to the process

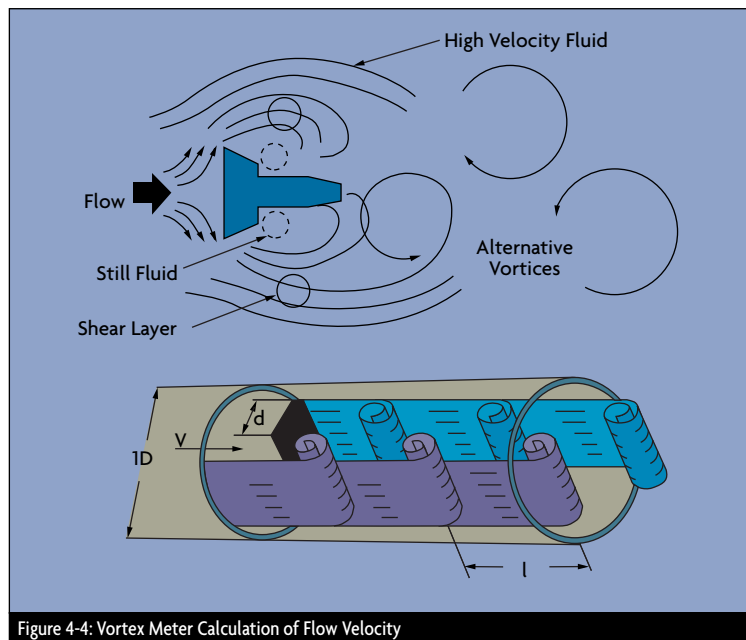

Figure 4-4: Vortex Meter Calculation of Flow Velocity

a pump status contact.

Magmeters require five diameters of straight pipe upstream and two diameters downstream in order to maintain their accuracy and minimize

fluid can be achieved by metal ground straps. These straps connect each end of the flowtube to the adjacent pipeline flanges, which, in turn, are in contact with the process



liquid. Straps are used when the piping is electrically conductive. When the pipe is non-conductive or lined, grounding rings are used. The grounding ring is like an orifice plate with a bore equal to the nominal size (inside diameter) of the flowtube. It is installed between the flanges of the flowtube and adjacent process piping on the upstream and downstream sides. The flowtube is bonded to the process fluid by being connected to the metallic grounding rings, and is grounded by being wired to a good conductor, such as a cold water pipe.

In larger sizes and in exotic materials, grounding rings can become expensive; grounding electrodes (a

Theodor von Karman discovered that, when a non-streamlined object (also called a bluff body) is placed in the path of a fast-flowing stream, the fluid will alternately separate from the object on its two downstream sides, and, as the boundary layer becomes detached and curls back on itself, the fluid forms vortices (also called whirlpools or eddies). He also noted that the distance between the vortices was constant and depended solely on the size of the rock that formed it.

On the side of the bluff body where the vortex is being formed, the fluid velocity is higher and the pressure is lower. As the vortex

a flagpole (which acts as a bluff body); this is what causes the regular rippling one sees in a flag. Vortices are also shed from bridge piers, pilings, offshore drilling platform supports, and tall buildings. The forces caused by the vortex-shedding phenomenon must be taken into account when designing these structures. In a closed piping system, the vortex effect is dissipated within a few pipe diameters downstream of the bluff body and causes no harm.

• **Vortex Meter Design**

A vortex flowmeter is typically made of 316 stainless steel or Hastelloy and includes a bluff body, a vortex sensor assembly and the transmitter electronics, although the latter can also be mounted remotely (Figure 4-5). They are typically available in flange sizes from 1/2 in. to 12 in. The installed cost of vortex meters is competitive with that of orifice meters in sizes under six inches. Wafer body meters (flangeless) have the lowest cost, while flanged meters are preferred if the process fluid is hazardous or is at a high temperature.

Bluff body shapes (square, rectangular, t-shaped, trapezoidal) and dimensions have been experimented with to achieve the desired characteristics. Testing has shown that linearity, low Reynolds number limitation, and sensitivity to velocity profile distortion vary only slightly with bluff body shape. In size, the bluff body must have a width that is a large enough fraction of the pipe diameter that the entire flow participates in the shedding. Second, the bluff body must have protruding edges on the upstream face to fix the lines of flow separation, regardless of the flow rate. Third, the bluff body

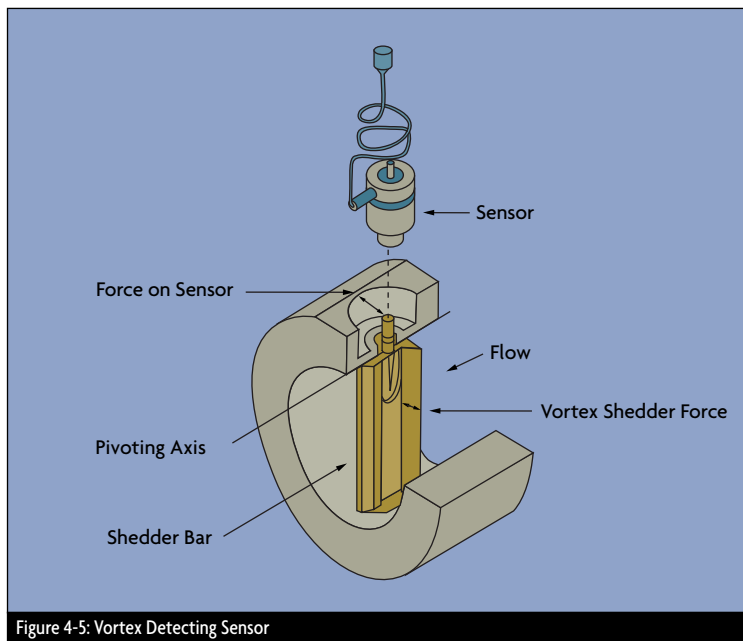

Figure 4-5: Vortex Detecting Sensor

third electrode placed in the flowtube for bonding with the process fluid) can be used instead. Another cost-saving option is to use a plastic grounding ring with a metal electrode insert.

**Vortex Flowmeters**

As a young person fishing in the mountain streams of the Transylvanian Alps,

moves downstream, it grows in strength and size, and eventually detaches or sheds itself. This is followed by a vortex's being formed on the other side of the bluff body (Figure 4-4). The alternating vortices are spaced at equal distances.

The vortex-shedding phenomenon can be observed as wind is shed from

length in the direction of the flow must be a certain multiple of the bluff body width.

Today, the majority of vortex meters use piezoelectric or capacitance-type sensors to detect the pressure oscillation around the bluff body. These detectors respond to the pressure oscillation with a low voltage output signal which has the same frequency as the oscillation. Such sensors are modular, inexpensive, easily replaced, and can operate over a wide range of temperature ranges—from cryogenic liquids to superheated steam. Sensors can be located inside the meter body or outside. Wetted sensors are stressed directly by the vortex pressure fluctuations and are enclosed in hardened cases to withstand corrosion and erosion effects.

External sensors, typically piezoelectric strain gages, sense the vortex shedding indirectly through the force exerted on the shedder bar. External sensors are preferred on highly erosive/corrosive applications to reduce maintenance costs, while internal sensors provide better rangeability (better low flow sensitivity). They are also less sensitive to pipe vibrations. The electronics housing usually is rated explosion- and weatherproof, and contains the electronic transmitter module, termination connections, and optionally a flow-rate indicator and/or totalizer.

• **Sizing & Rangeability**

Vortex shedding frequency is directly proportional to the velocity of the fluid in the pipe, and therefore to volumetric flow rate. The shedding frequency is independent of fluid properties such as density, viscosity, conductivity, etc., except that the flow must be turbulent for vortex shedding

to occur. The relationship between vortex frequency and fluid velocity is:

$$St = f(d/V)$$

Where St is the Strouhal number, f is the vortex shedding frequency, d is

area available for flow (A):

$$Q = AV = (A f d B)/St$$

where B is the blockage factor, defined as the open area left by the bluff body divided by the full bore

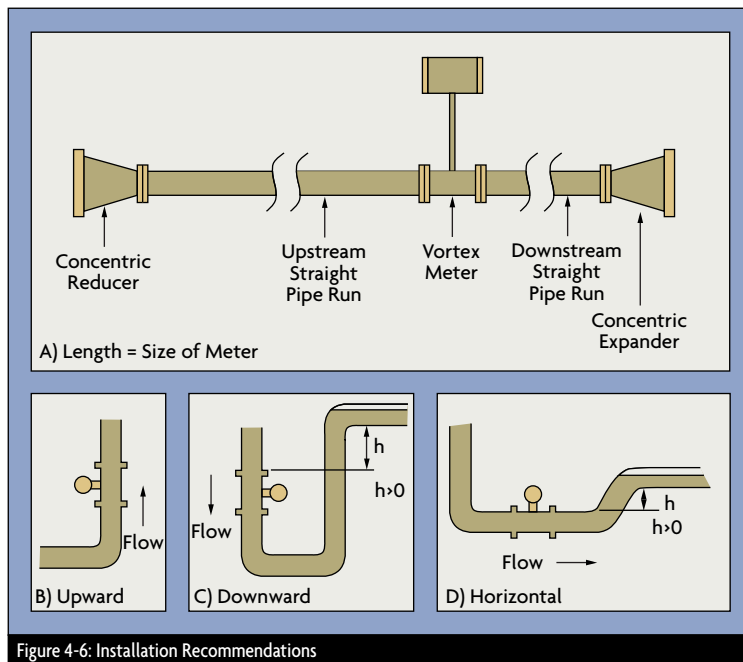

Figure 4-6: Installation Recommendations

the width of the bluff body, and V is the average fluid velocity. The value of the Strouhal number is determined experimentally, and is generally found to be constant over a wide range of Reynolds numbers. The Strouhal number represents the ratio of the interval between vortex shedding (l) and bluff body width (d), which is about six (Figure 4-4). The Strouhal number is a dimensionless calibration factor used to characterize various bluff bodies. If their Strouhal number is the same, then two different bluff bodies will perform and behave similarly.

Because the volumetric flowrate Q is the product of the average fluid velocity and of the cross-sectional

area of the pipe. This equation, in turn, can be rewritten as:

$$Q = f K$$

where K is the meter coefficient, equal to the product (A f d B). As with turbine and other frequency-producing flowmeters, the K factor can be defined as pulses per unit volume (pulses per gallon, pulses per cubic foot, etc.). Therefore, one can determine flowrate by counting the pulses per unit time. Vortex frequencies range from one to thousands of pulses per second, depending upon the flow velocity, the character of the process fluid, and the size of the meter. In gas service, frequencies are

about 10 times higher than in liquid applications.

The K factor is determined by the manufacturer, usually by water calibration in a flow lab. Because the K factor is the same for liquid, gas and vapor applications, the value determined from a water calibration is valid

the density or viscosity of the fluid differs from that of water, the meter range will change.

In order to minimize measurement noise, it is important to select a meter that will adequately handle both the minimum and maximum process flows that will be measured.

than 10,000, error can reach 10% of actual flow.

While most flowmeters continue to give some indication at near zero flows, the vortex meter is provided with a cut-off point. Below this level, the meter output is automatically clamped at zero (4 mA for analog

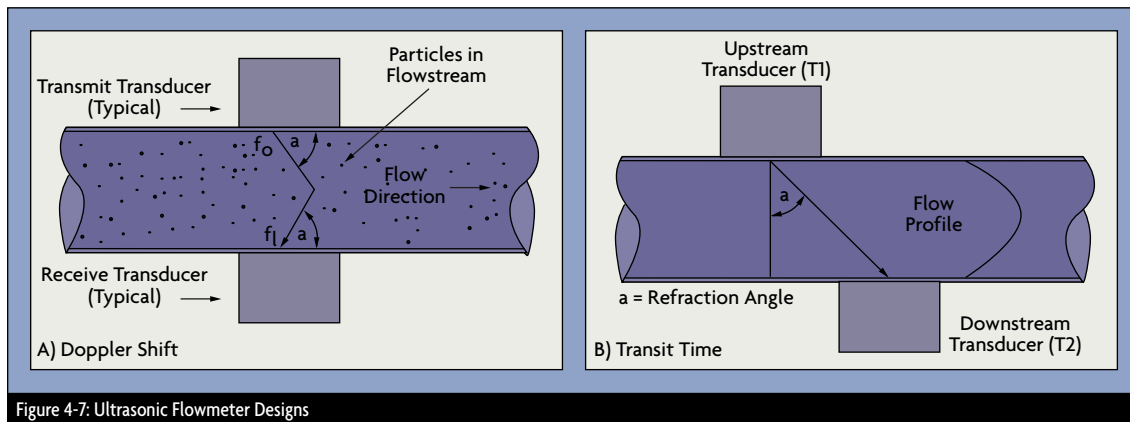

Figure 4-7: Ultrasonic Flowmeter Designs

for any other fluid. The calibration factor (K) at moderate Reynolds numbers is not sensitive to edge sharpness or other dimensional changes that affect square-edged orifice meters.

Although vortex meter equations are relatively simple compared to those for orifice plates, there are many rules and considerations to keep in mind. Manufacturers offer free computer software for sizing, wherewith the user enters the fluid's properties (density, viscosity, and desired flow range) and the program automatically sizes the meter.

The force generated by the vortex pressure pulse is a function of fluid density multiplied by the square of fluid velocity. The requirement that there be turbulent flow and force sufficient to actuate the sensor determines the meter's rangeability. This force has to be high enough to be distinguishable from noise. For example, a typical 2-in. vortex meter has a water flow range of 12 to 230 gpm. If

It is recommended that the minimum flow rate to be measured be at least twice the minimum flow rate detectable by the meter. The maximum capacity of the meter should be at least five times the anticipated maximum flowrate.

• Accuracy & Rangeability

Because the Reynolds number drops as viscosity rises, vortex flowmeter rangeability suffers as the viscosity rises. The maximum viscosity limit, as a function of allowable accuracy and rangeability, is between 8 and 30 centipoises. One can expect a better than 20:1 rangeability for gas and steam service and over 10:1 for low-viscosity liquid applications if the vortex meter has been sized properly for the application.

The inaccuracy of most vortex meters is 0.5-1% of rate for Reynolds numbers over 30,000. As the Reynolds number drops, metering error increases. At Reynolds numbers less

than 10,000, error can reach 10% of actual flow. This cut-off point corresponds to a Reynolds number at or below 10,000. If the minimum flow that one needs to measure is at least twice the cut-off flow, this does not pose a problem. On the other hand, it can still be a drawback if low flowrate information is desired during start-up, shutdown, or other upset conditions.

• Recent Developments

Smart vortex meters provide a digital output signal containing more information than just flow rate. The microprocessor in the flowmeter can automatically correct for insufficient straight pipe conditions, for differences between the bore diameter and that of the mating pipe, for thermal expansion of the bluff body, and for K-factor changes when the Reynolds number drops below 10,000.

Intelligent transmitters are also provided with diagnostic subroutines

to signal component or other failures. Smart transmitters can initiate testing routines to identify problems with both the meter and with the application. These on-demand tests can also assist in ISO 9000 verification.

Some recently introduced vortex flowmeters can detect mass flow. One such design measures both the vortex frequency and the vortex pulse strength simultaneously. From these readings, the density of the process fluid can be determined and the mass flow calculated to within 2% of span.

Another newer design is provided with multiple sensors to detect not only the vortex frequency, but also the temperature and pressure of the process fluid. Based on that data, it determines both the density and the mass flow rate. This meter offers a 1.25% of rate accuracy when measuring the mass flow of liquids and a 2% of rate accuracy for gases and steam. If knowledge of process pressure and temperature is of value for other reasons, this meter provides a convenient, less costly alternative to installing separate transmitters.

• **Applications & Limitations**

Vortex meters are not usually recommended for batching or other intermittent flow applications. This is because the dribble flow-rate setting of the batching station can fall below the meter's minimum Reynolds number limit. The smaller the total batch, the more significant the resulting error is likely to be.

Low pressure (low density) gases do not produce a strong enough pressure pulse, especially if fluid velocities are low. Therefore, it is likely that in such services the rangeability of the meter will be poor and low flows will not be

measurable. On the other hand, if reduced rangeability is acceptable and the meter is correctly sized for normal flow, the vortex flowmeter can still be considered.

If the process fluid tends to coat or build-up on the bluff body, as in sludge and slurry service, this will eventually change the meter's K factor. Vortex-shedding flowmeters are not recommended for such applications. If, however, a dirty fluid has only moderate amounts of non-coating solids, the application is likely to be acceptable. This was demonstrated by a 2-year test on a limestone slurry. At the end of the test, the K factor was found to have changed only 0.3% from the original factory calibration, although the bluff body and flowtube were badly scarred and pitted.

When measuring multi-phase flow (solid particles in gas or liquid; gas bubbles in liquid; liquid droplets in gas), vortex meter accuracy will drop

liquid phase is likely to travel on the bottom of the pipe, and therefore the inner area of the pipe should be kept open at the bottom. This can be achieved by installing the bluff body horizontally. Measurement inaccuracy in such applications is about 5% of actual flow, but with good repeatability.

The permanent pressure loss through a vortex meter is about half that of an orifice plate, roughly two velocity heads. (A velocity head is defined as  $V^2/g$ , where V is the flow velocity and g is the gravitational constant in consistent units.) If the pipe and meter are properly sized and of the same size, the pressure drop is likely to be only a few psi. However, downsizing (installing a smaller-than-line-size meter) in order to increase the Reynolds can increase the head loss to more than 10 psi. One should also make sure that the vena contracta pressure does not drop below the vapor pres-

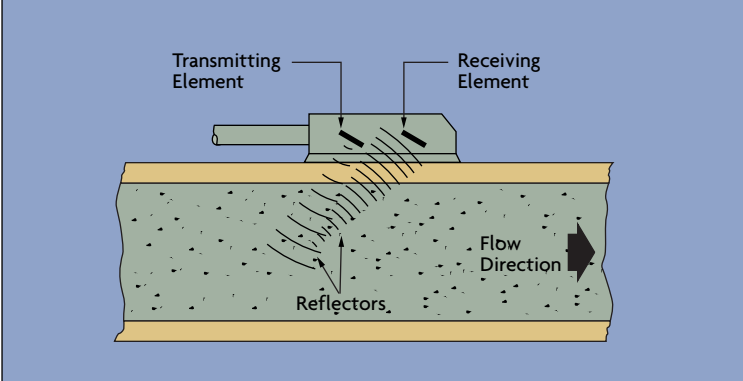

Figure 4-8: Clamp-On Ultrasonic Flowmeter

because of the meter's inability to differentiate between the phases. Wet, low-quality steam is one such application: the liquid phase should be homogeneously dispersed within the steam, and vertical flow lines should be avoided to prevent slugging. When the pipe is horizontal, the

sure of the process fluid, because that would cause cavitation. Naturally, if the back-pressure on the meter is below the vapor pressure, the process fluid will flash and the meter reading will not be meaningful.

The main advantages of vortex meters are their low sensitivity to

variations in process conditions and low wear relative to orifices or turbine meters. Also, initial and maintenance costs are low. For these reasons, they have been gaining wider acceptance among users.

• **Installation Recommendations**

When installing a vortex flowmeter in an existing process where the flow rate is not known, it is recommended

About half of all vortex meter installations require the “necking down” of oversized process piping by concentric reducers and expanders. Even if flow straighteners are installed, some straight (relaxation) piping will still be required.

Vortex meters can be installed vertically, horizontally, or at any angle, as long as they are kept flooded. The meter can be kept flooded

meter. The bores of the meter, the gaskets and the adjacent piping must be carefully aligned to eliminate any obstructions or steps.

Excessive pipe vibration can be eliminated by supporting the piping on both sides of the meter, or by rotating the meter so that the sensor is moved out of the plane of the vibration. Process noise due to valve chattering, steam traps, or pumps can

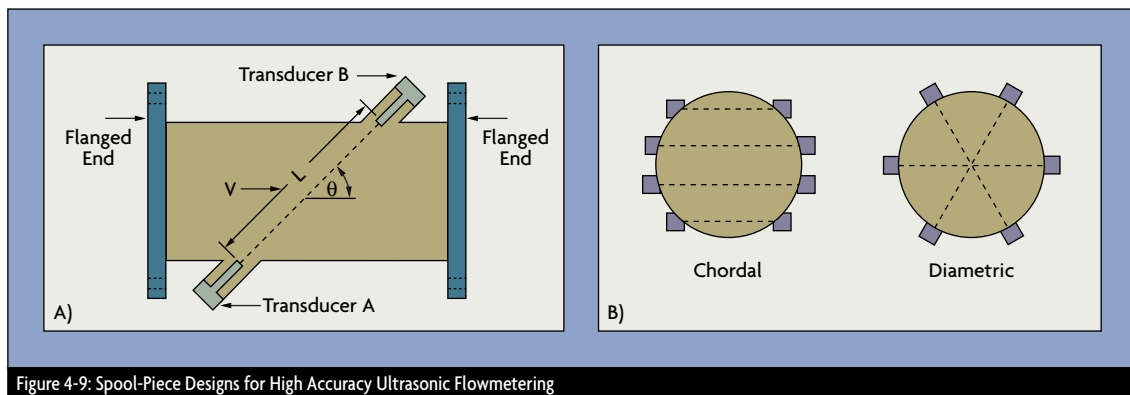

Figure 4-9: Spool-Piece Designs for High Accuracy Ultrasonic Flowmetering

to first make some approximate measurements (using portable pitot or clamp-on ultrasonic devices). Otherwise, there is no guarantee that a line-size vortex meter will work at all.

The vortex meter requires a well-developed and symmetrical flow velocity profile, free from any distortions or swirls. This necessitates the use of straight up- and downstream piping to condition the flow. The straight length of pipe must be the same size as the meter (Figure 4-6) and its length should be about the same as required for an orifice installation with a beta ratio of 0.7 (see Chapter 2). Most vortex flowmeter manufacturers recommend a minimum of 30 pipe diameters downstream of control valves, and 3 to 4 pipe diameters between the meter and downstream pressure taps. Temperature elements should be small and located 5 to 6 diameters downstream.

by installing it in a vertical upward flow line (Figure 4-6B). When installing the flowmeter in a downward (Figure 4-6C) or horizontal (Figure 4-6D) flow, the downstream piping should be kept elevated. Check valves can be used to keep the piping full of liquid when there is no flow. Block and bypass valves are required if the replacement of the sensor in the particular design requires the stopping of the flow and the opening up of the process.

Mating flanges (on the schedule 40 or schedule 80 mating piping) must have the same diameter and smooth bore as the flowmeter. Weld neck flanges are preferred, and reducing flanges should not be used. The inner surface of the mating pipe should be free from mill scale, pits, holes, reaming scores and bumps for a distance of 4 diameters upstream and 2 diameters downstream of the

result in high readings or non-zero readings under zero-flow conditions. Most meter electronics allow for increasing the noise filter settings, but increased noise reduction usually also decreases the low-flow sensitivity of the meter. One option is to relocate the meter to a less noisy part of the process.

**Ultrasonic Flowmeters**

The speed at which sound propagates in a fluid is dependent on the fluid’s density. If the density is constant, however, one can use the time of ultrasonic passage (or reflection) to determine the velocity of a flowing fluid.

Some manufacturers produce transducer systems that operate in the shear-mode, sending a single pulse and receiving a single pulse in return. Narrow-beam systems are commonly subject to walk-away (the

signal completely missing the downstream transducer). Wide-beam systems overcome beam refraction and work better in changing liquid density and temperature. With the advent of digital signal processing, it has become possible to apply digital signal coding to the transmitted signal. This can eliminate many of the problems associated with noise and variations in liquid chemistry.

• **The Doppler Shift**

In 1842, Christian Doppler discovered that the wavelength of sound perceived by a stationary observer appears shorter when the source is approaching and longer when the source is moving away. This shift in frequency is the basis upon which all Doppler-shift ultrasonic flowmeters work.

Doppler flowmeter transducers operate at 0.640 MHz (in clamp-on designs) and at 1.2 MHz in wetted sensor designs. The transducer sends an ultrasonic pulse or beam into the flowing stream. The sound waves are reflected back by such acoustical discontinuities as particles, entrained gas bubbles, or even by turbulence vortices (Figure 4-7A). For clamp-on designs, measurement inaccuracy ranges from ±1% to ±5% full scale (FS).

The meter detects the velocity of the discontinuities, rather than the velocity of the fluid, in calculating the flow rate. The flow velocity (V) can be determined by:

$$V = (f_0 - f_1)C_t / 2f_0 \cos(a)$$

Where  $C_t$  is the velocity of sound inside the transducer,  $f_0$  is the transmission frequency,  $f_1$  is the reflected frequency, and  $a$  is the angle of the transmitter and receiver crystals with respect to the pipe axis.

Because  $C_t / 2f_0 \cos(a)$  is a constant (K), the relationship can be simplified to:

$$V = (f_0 - f_1)K$$

Thus, flow velocity V (ft/sec) is directly proportional to the change in frequency. The flow (Q in gpm) in a pipe having a certain inside diameter (ID in inches) can be obtained by:

$$Q = 2.45V(ID)^2 = 2.45[(f_0 - f_1)K](ID)^2$$

The presence of acoustical discontinuities is essential for the proper operation of the Doppler flowmeter. The generally accepted rule of thumb is that for proper signal reflection there be a minimum of 80-100 mg/l of solids with a particle size of +200 mesh (+75 micron). In the case of bubbles, 100-200 mg/l with diameters between +75 and +150 microns is desirable. If either the size or the concentration of the discontinuities changes, the amplitude of the reflected signal will shift, introducing errors.

Doppler flowmeters are often used to measure the flow of such fluids as

will attenuate the reflected Doppler signal to the point where it cannot be distinguished from the background noise in the pipe.

The reflected Doppler signal is shifted from the transmitted frequency by approximately 6 Hz for every foot per second of velocity. Therefore, if the flow velocity is less than 1 ft/sec, ultrasonic flowmetering is not practical. There seems to be no upper limit to detectable flow velocity, as successful installations at velocities in the 40-50 ft/sec range are well documented.

• **Transit Time Measurement**

In this design, the time of flight of the ultrasonic signal is measured between two transducers—one upstream and one downstream (Figure 4-7B). The difference in elapsed time going with or against the flow determines the fluid velocity.

When the flow is zero, the time for the signal  $T_1$  to get to  $T_2$  is the same as that required to get from  $T_2$  to  $T_1$ . When there is flow, the effect is to boost the speed of the signal in the downstream direction, while decreasing it in the upstream direction. The

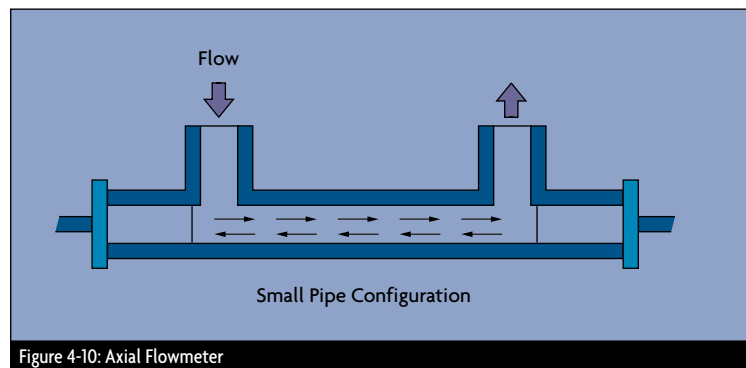

Figure 4-10: Axial Flowmeter

slurries. If the solids concentration is too high (in excess of 45% by weight), or if too much air or gas is entrained (especially if the bubbles are very fine), these discontinuities

flowing velocity ( $V_f$ ) can be determined by the following equation:

$$V_f = Kdt / T_L$$



where  $K$  is a calibration factor for the volume and time units used,  $dt$  is the time differential between upstream and downstream transit times, and  $T_L$  is the zero-flow transit time.

Theoretically, transit-time ultrasonic meters can be very accurate

In the single-sensor version, the transmit and receive crystals are potted into the same sensor body, which is clamped onto a single point of the pipe surface (Figure 4-8). In the dual-sensor version, the transmit crystal is in one sensor body, while the receive

transmitted signal or attenuate the return signal. This dramatically decreases flowmeter accuracy (to within only  $\pm 20\%$ ), and, in most cases, clamp-on meters will not work at all if the pipe is lined.

Wetted transducer designs—both Doppler and transit time—are available—overcome many of these signal attenuation limitations. The full-pipe transit-time meter originally consisted of a flanged spool section with wetted transducers mounted in the pipe wall in transducer wells opposite to one another but at 45-degree angles to the flow (Figure 4-9A). Transit-time flowmeters can be either single-path or multiple-path designs (Figure 4-9B).

Single-path flowmeters are provided with a single pair of transducers that make a single-line velocity measurement. They use a meter factor that is pre-determined by calibration to compensate for variations in velocity profile and for flow section construction irregularities.

In the design of multi-path flowmeters, several sets of transducers are placed in different paths across the flow section, thereby attempting to measure the velocity profile across the entire cross-section of the pipe. Multi-path instruments are used in large-diameter conduits, such as utility stacks, and in other applications where non-uniform flow velocity profiles exist.

Transit-time meters can also be used to measure both very hot (e.g., liquid sulfur) and very cold (liquid nitrogen) fluids, and also to detect very low flows. Wetted-transducer designs for small pipes (down to  $\frac{1}{2}$  in.) are called axial or co-axial designs (Figure 4-10). These devices permit transit-time measurement along a path length significantly greater than the diameter of the pipe, increasing

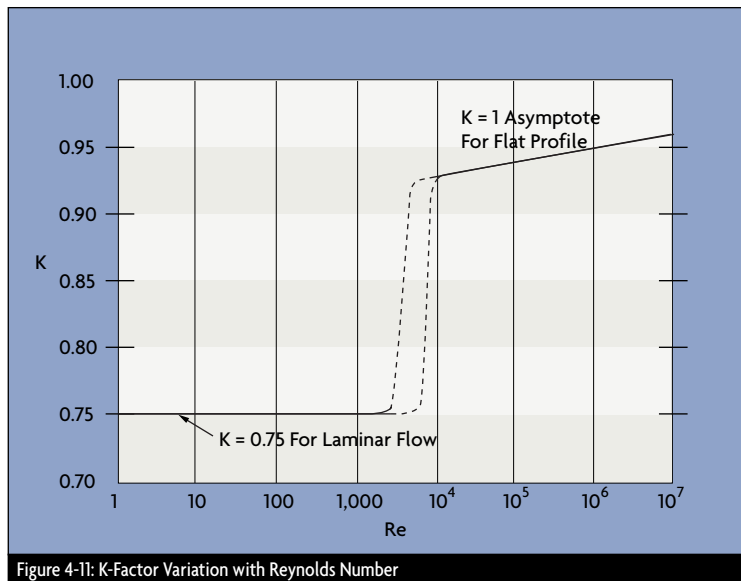

Figure 4-11: K-Factor Variation with Reynolds Number

(inaccuracy of  $\pm 0.1\%$  of reading is sometimes claimed). Yet the error in these measurements is limited by both the ability of the signal processing electronics to determine the transit time and by the degree to which the sonic velocity ( $C$ ) is constant. The speed of sound in the fluid is a function of both density and temperature. Therefore, both have to be compensated for. In addition, the change in sonic velocity can change the refraction angle (“ $a$ ” in Figure 4-7B), which in turn will affect the distance the signal has to travel. In extreme cases, the signal might completely miss the downstream receiver. Again, this type of failure is known as walk-away.

• Design Variations

Clamp-on ultrasonic meters come in either single or dual-sensor versions.

crystal is in another.

Clamp-on transit time meters have been available since the early 1970s. Their aim is to rival the performance of wetted spool-piece designs, but without the need to break the pipe or stop the process to install the meter. This goal has not yet been reached.

Clamp-on Doppler flowmeters are subject to interference from the pipe wall itself, as well as from any air space between the sensor and the wall. If the pipe wall is made of stainless steel, it might conduct the transmit signal far enough so that the returning echo will be shifted enough to interfere with the reading. There are also built-in acoustic discontinuities in concrete-lined, plastic-lined, and fiberglass-reinforced pipes. These are significant enough to either completely scatter the

low-flow sensitivity.

Originally, ultrasonic flowmeters were divided into those using the Doppler-shift principle and those using the transit-time principle. More recently, flowmeters are capable of measuring the flow of both clean fluids and of slurries with entrained solids or other acoustical discontinuities. Microprocessors have made it possible to switch automatically from clean fluid mode to particulate mode based on the "correlation factor". This figure of merit dramatically improves the accuracy of overall performance. In some carefully engineered applications, installed accuracy to within 0.5% of reading has been reported.

#### • Applications & Performance

Doppler flowmeters are not recommended for clean fluid applications. Transit-time flowmeters, on the other hand, are often used to measure the flow of crude oils and simple fractions in the petroleum industry. They also work well with viscous liquids, provided that the Reynolds number at minimum flow is either less than 4,000 (laminar flow) or above 10,000 (turbulent flow). Serious non-linearities are present in the transition region (Figure 4-11).

Transit-time flowmeters are the standard for measuring cryogenic liquids down to -300°C and are also used in molten metal flowmetering. Measurement of liquid argon, liquid nitrogen, liquid helium and molten sulfur have often been reported. Spool-section type flowmeters are most often used for these applications, especially the axial and co-axial designs.

Raw wastewater applications usually have too few acoustic discontinuities for Doppler flowmeters. On

the other hand, raw wastewater is not clean enough all the time for transit-time measurement. Other wastewater-related applications are equally problematic, as the solids concentration can be too high for either transit-time or Doppler flowmeters to work properly. In still other wastewater applications, the problem is that the acoustical absorbency of the mostly organic solids in wastewater attenuates the ultrasonic signals.

The use of multi-path flowmeters in raw wastewater and storm water applications is common, while Doppler or cross-correlation hybrid designs are most often used to measure activated sludge and digested sludge flows.

For mining slurries, Doppler flowmeters typically work well. Among the few problem applications

are those in HDPE pipe, because the pipe wall flexes enough to change the diameter of the measurement area. This affects the accuracy of the meter. In addition, the flexure of the pipe wall can often break the acoustic coupling of the transducer to the outside of the pipe, causing failure. Another problem area is the measurement of slurries that are acoustically absorbent, such as lime or kaolin slurries. These applications fail because the highly absorbent solids attenuate the signal below usable strength. Lower frequency (0.45 MHz) sensors have been tried for these applications, but success has been limited.

Multi-path, transit-time flowmeters also measure stack gas flows in power-plant scrubbers, even in very large diameter stacks. 

### References & Further Reading

- OMEGA *Complete Flow and Level Measurement Handbook and Encyclopedia*®, OMEGA Press, 1995.
- OMEGA *Volume 29 Handbook & Encyclopedia, Purchasing Agents Edition*, OMEGA Press, 1995.
- "An Intelligent Vortex Flowmeter," T. Kamano and others, *ISA/92 Proceedings*, Instrument Society of America, 1992.
- "Application and Installation Guidelines for Volumetric and Mass Flowmeters," D. Ginesi and C. Annarummo, *ISA Transactions*, 1994.
- "Clamp-On Leak Detectors Protect Mid-Valley Line," S. Douglas and J. Baumuel, *Pipeline & Gas Journal*, April 1993.
- "Committee Report: Transit Time Ultrasonic Flowmeters," AWWA Subcommittee on Ultrasonic Devices, *AWWA Journal*, July 1997.
- *Flow Measurement Engineering Handbook*, R.W. Miller, McGraw Hill, 1996.
- *Flow Measurement*, D.W. Spitzer, editor, Instrument Society of America, 1991.
- "Flow Sensing: The Next Generation," D. Ginesi, *Control Engineering*, November 1997.
- *Flowmeters in Water Supply*, Manual M33, AWWA, 1989.
- *Industrial Flow Measurement*, D.W. Spitzer, ISA, 1984
- *Instrument Engineers' Handbook*, Bela Liptak, editor, CRC Press, 1995.
- Ultrasonic Clamp-On Flowmeters: Have They Finally Arrived?," P. Espina, *Flow Control*, January 1997.
- *Water Meters - Selection, Installation, Testing and Maintenance*, Manual M6, AWWA, 1986.

- Coriolis Mass Flowmeters
- Thermal Mass Flowmeters
- Hot-Wire Anemometers

# Mass Flowmeters

**M**ass flow measurement is the basis of most recipe formulations, material balance determinations, and billing and custody transfer operations throughout industry. With these being the most critical flow measurements in a processing plant, the reliability and accuracy of mass flow detection is very important.

In the past, mass flow was often calculated from the outputs of a volumetric flowmeter and a densitometer. Density was either directly measured (Figure 5-1A), or was calculated using the outputs of process temperature and pressure transmitters. These measurements were not very accurate, because the relationship between process pressure or temperature and density are not always precisely known—each sensor adds its

own separate error to the overall measurement error, and the speed of response of such calculations is usually not sufficient to detect step changes in flow.

using angular momentum (Figure 5-1B). It had a motor-driven impeller that imparted angular momentum (rotary motion) by accelerating the fluid to a constant angular velocity. The higher the density, the more angular momentum was required to obtain this angular velocity. Downstream of the driven impeller, a spring-held stationary turbine was exposed to this angular momentum. The resulting torque (spring torsion) was an indication of mass flow.

These meters all had moving parts and complex mechanical designs. First developed for the measurement of aircraft fuel, some are still in use. However, because of their complex nature and high maintenance costs, they are gradually being replaced by more robust and less maintenance-demanding designs.

output of the top d/p cell will vary with the level in the tank, while the lower one will measure the hydrostatic head over a fixed elevational distance. This pressure differential yields the density of the material in the tank. Such systems have been used to measure the total mass flow of slurries.

## Coriolis Mass Flowmeters

It was G.G. Coriolis, a French engineer, who first noted that all bodies moving on the surface of the Earth tend to drift sideways because of the eastward rotation of the planet. In the Northern Hemisphere the deflection is to the right of the motion; in the Southern, it is to the left. This drift plays a principal role in both the tidal activity of the oceans and the weather of the planet.

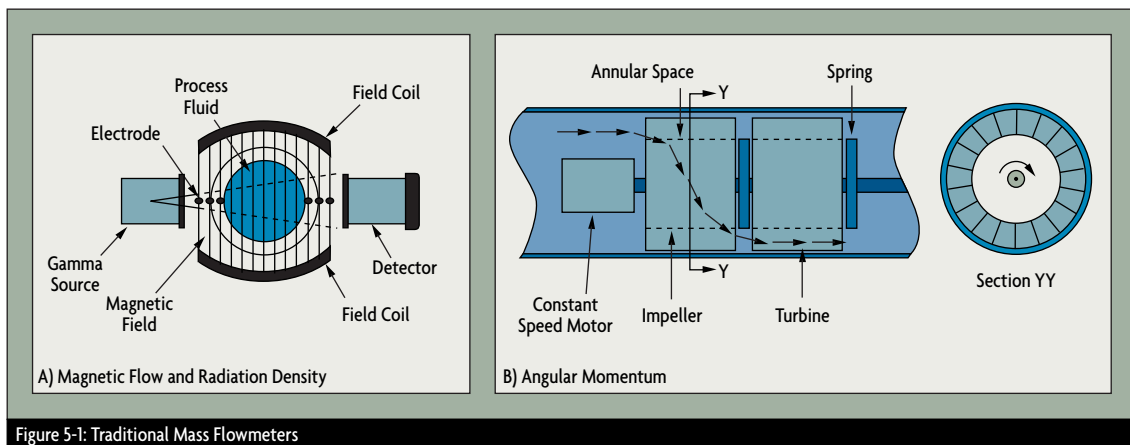

Figure 5-1: Traditional Mass Flowmeters

own separate error to the overall measurement error, and the speed of response of such calculations is usually not sufficient to detect step changes in flow.

One of the early designs of self-contained mass flowmeters operated

Mass flow also can be measured by batch weighing or by combining an accurate level sensor with a densitometer. Another method is to mount two d/p transmitters on the lower part of an atmospheric tank at different elevations. In this case, the

Because a point on the equator traces out a larger circle per day than a point nearer the poles, a body traveling towards either pole will bear eastward, because it retains its higher (eastward) rotational speed as it passes over the more slowly

rotating surface of the earth. This drift is defined as the Coriolis force.

The first industrial Coriolis patents date back to the 1950s, and the first Coriolis mass flowmeters were built in the 1970s. These flowmeters artificially introduce a Coriolis acceleration into the flowing stream and measure mass flow by detecting the resulting angular momentum.

centripetal acceleration directed toward P and a Coriolis acceleration acting at right angles to  $a_r$ :

$$\begin{aligned} a_r \text{ (centripetal)} &= w^2r \\ a_t \text{ (Coriolis)} &= 2wv \end{aligned}$$

In order to impart the Coriolis acceleration ( $a_t$ ) to the fluid particle, a force of  $a_t (dm)$  has to be generated by

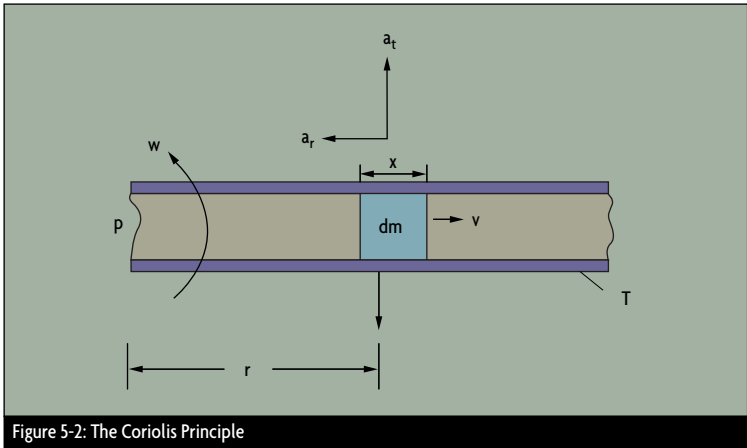

Figure 5-2: The Coriolis Principle

When a fluid is flowing in a pipe and it is subjected to Coriolis acceleration through the mechanical introduction of apparent rotation into the pipe, the amount of deflecting force generated by the Coriolis inertial effect will be a function of the mass flow rate of the fluid. If a pipe is rotated around a point while liquid is flowing through it (toward or away from the center of rotation), that fluid will generate an inertial force (acting on the pipe) that will be at right angles to the direction of the flow.

With reference to Figure 5-2, a particle ( $dm$ ) travels at a velocity ( $V$ ) inside a tube ( $T$ ). The tube is rotating about a fixed point ( $P$ ), and the particle is at a distance of one radius ( $R$ ) from the fixed point. The particle moves with angular velocity ( $w$ ) under two components of acceleration, a

the tube. The fluid particle reacts to this force with an equal and opposite Coriolis force:

$$F_c = a_t(dm) = 2wv(dm)$$

Then, if the process fluid has density  $D$  and is flowing at constant speed inside a rotating tube of cross-sectional area  $A$ , a segment of the tube of length  $x$  will experience a Coriolis force of magnitude:

$$F_c = 2wvDAx$$

Because the mass flowrate is  $dm = DvA$ , the Coriolis force  $F_c = 2w(dm)x$  and, finally:

$$\text{Mass Flow} = F_c / (2wx)$$

This is how measurement of the Coriolis force exerted by the flowing

fluid on the rotating tube can provide an indication of mass flowrate. Naturally, rotating a tube is not practical when building a commercial flowmeter, but oscillating or vibrating the tube can achieve the same effect. Coriolis flowmeters can measure flow through the tube in either the forward or reverse directions.

In most designs, the tube is anchored at two points and vibrated between these anchors.

This configuration can be envisioned as vibrating a spring and mass assembly. Once placed in motion, a spring and mass assembly will vibrate at its resonant frequency, which is a function of the mass of that assembly. This resonant frequency is selected because the smallest driving force is needed to keep the filled tube in constant vibration.

• Tube Designs

A tube can be of a curved or straight form, and some designs can also be self-draining when mounted vertically (Figure 5-3). When the design consists of two parallel tubes, flow is divided into two streams by a splitter near the meter's inlet and is recombined at the exit. In the single continuous tube design (or in two tubes joined in series), the flow is not split inside the meter.

In either case, drivers vibrate the tubes. These drivers consist of a coil connected to one tube and a magnet connected to the other. The transmitter applies an alternating current to the coil, which causes the magnet to be attracted and repelled by turns, thereby forcing the tubes towards and away from one another. The sensor can detect the position, velocity, or acceleration of the tubes. If electromagnetic sensors are used, the magnet and coil in the sensor change their

relative positions as the tubes vibrate, causing a change in the magnetic field of the coil. Therefore, the sinusoidal voltage output from the coil represents the motion of the tubes.

When there is no flow in a two-tube design (Figure 5-3A), the vibration caused by the coil and magnet drive results in identical displacements at the two sensing points (B1 and B2). When flow is present, Coriolis forces act to produce a secondary twisting vibration, resulting in

output from the meter.

The natural resonance frequency of the tube structure is a function of its geometry, materials of construction, and the mass of the tube assembly (mass of the tube plus the mass of the fluid inside the tube). The mass of the tube is fixed. Since mass of the fluid is its density ( $D$ ) multiplied by its volume (which is also fixed), the frequency of vibration can be related to the density of the process fluid ( $D$ ). Therefore, the

the sturdiest tubing will be thinner than the process piping. In addition, some designs use small bore tubing, which drastically increases the flowing velocity (from 5-10 ft/sec to more than 25 ft/sec). Designs with thin walls and high fluid velocities (that is, small bore tubing), may require the use of exotic materials because of erosion concerns. One will obtain the longest meter life by selecting the design with the thickest wall and the slowest flow velocity that can provide

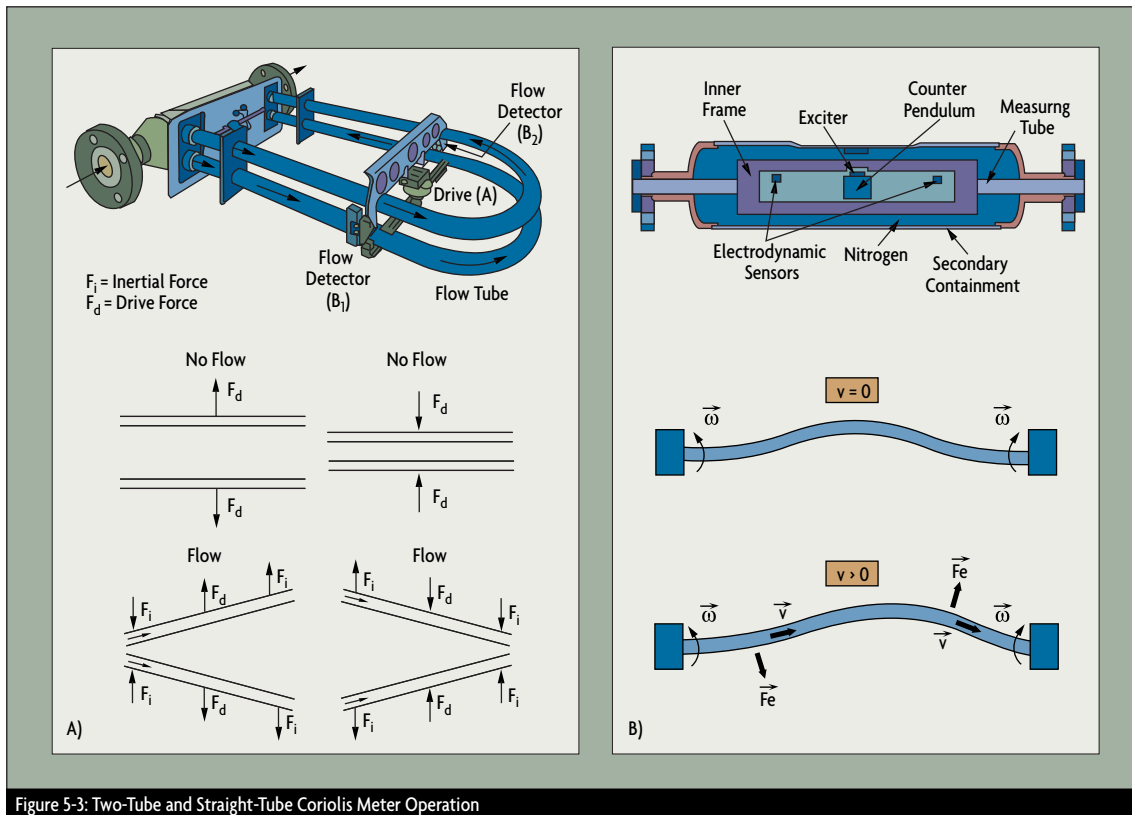

Figure 5-3: Two-Tube and Straight-Tube Coriolis Meter Operation

a small phase difference in the relative motions. This is detected at the sensing points. The deflection of the tubes caused by the Coriolis force only exists when both axial fluid flow and tube vibration are present. Vibration at zero flow, or flow without vibration, does not produce an

density of the fluid can be determined by measuring the resonant frequency of oscillation of the tubes. (Note that density can be measured at zero flow, as long as the tubes are filled with fluid and vibrating.)

Wall thickness varies considerably from design to design; however, even

the required accuracy and range.

The Coriolis meter may need to be made out of exotic materials because of corrosion considerations or to prevent pitting. Carbon or stainless steel can often be used in process piping, because a small amount of pitting can be tolerated. In case of the

Coriolis meter, even a small amount of pitting cannot be tolerated because the walls are thin, and pitting induces stress concentrations within the tube structure. Therefore, standard corrosion tables (based on weight loss criteria) are not suitable for selecting Coriolis tube materials, and the stricter guidelines of the manufacturers must be used.

• **Transmitter Designs**

Transmitters can operate on either ac or dc power and require separate wiring for the power supply and for their output signals. The Coriolis flowmeter transmitter can be integrally or remotely mounted (Figure 5-4). The transmitter controls the operation of the driver and processes and transmits the sensor signals. The calibration factor (K) in the transmitter's memory matches the transmitter to the particular flow tube. This calibration factor defines the constant of proportionality between the Coriolis force and the mass flow rate for the dynamic spring constant of the particular vibrating tubes.

The transmitter does more than convert sensor inputs into standardized output signals. Most transmitters also offer multiple outputs, including mass flow rate, total mass flow, density, and temperature. Analog and/or pulse outputs are both available, and intelligent transmitters can generate digital outputs for integration into DCS systems.

Transmitters are often provided with a local displays and keypads to allow easy access to process data. Coriolis transmitters provide more than just flow information and ancillary functions. Batch control functions, percent Brix or percent HFCS monitoring, viscosity, percent solids, PID, API gravity, and specific gravity

also are available. When viscosity information is desired, the meter pressure drop needs to be measured. Other features may require information to be pre-programmed into the transmitter memory. In addition,

reference to a fixed point or plane. The tubes were excited in such a way that localized high amplitude bending forces were created at the anchor points. This resulted in severe vibration problems, which were alleviated

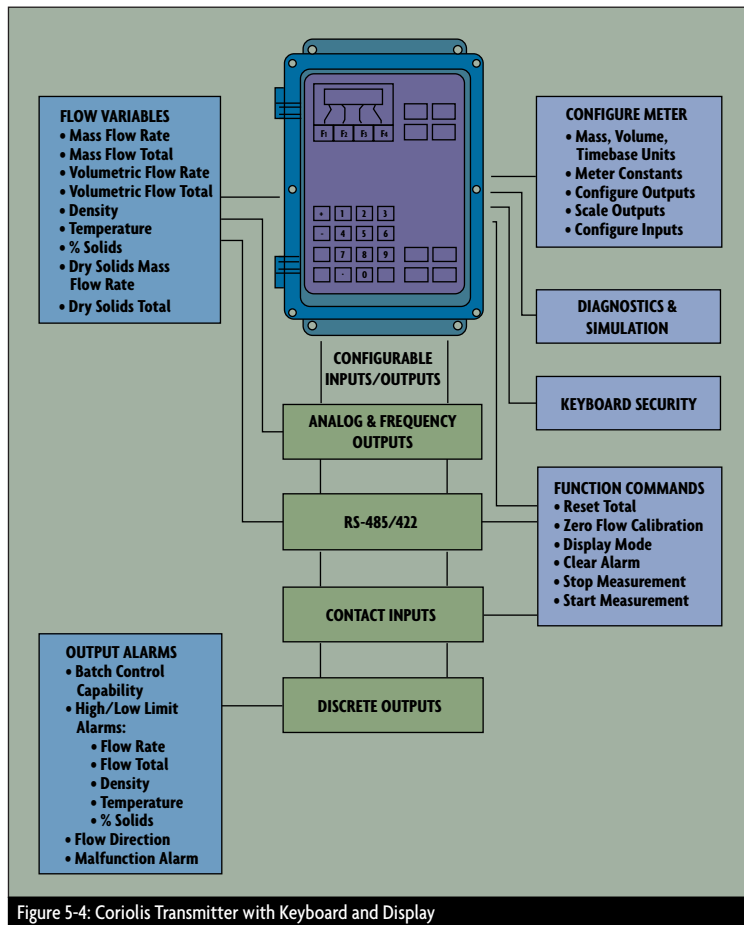

Figure 5-4: Coriolis Transmitter with Keyboard and Display

transmitters have other hardware and software options which allow the user to customize them to the application.

• **Coriolis Evolution**

The first generation of Coriolis meters consisted of a single curved and a thin-walled tube, in which high fluid velocities were created by reducing the tube cross-sectional area in relation to the process pipe. The tube distortion was measured in

by two-tube designs (Figure 5-3A).

These designs reduced external vibration interference, decreased the power needed to vibrate the tubes, and minimized the vibrational energy leaving the tube structure. One driver was used to initiate tube vibration, and two sensors were used to detect the Coriolis deflections. While this design greatly improved performance, the combination of reduced bore, thin-walled tubing, and high fluid

velocities (up to 50 ft/sec) still resulted in premature meter failure, including potentially catastrophic spills

the number of suppliers and contributed to the development of a new generation of Coriolis meters

tube temperature is continuously measured by an RTD element and is used to continuously compensate

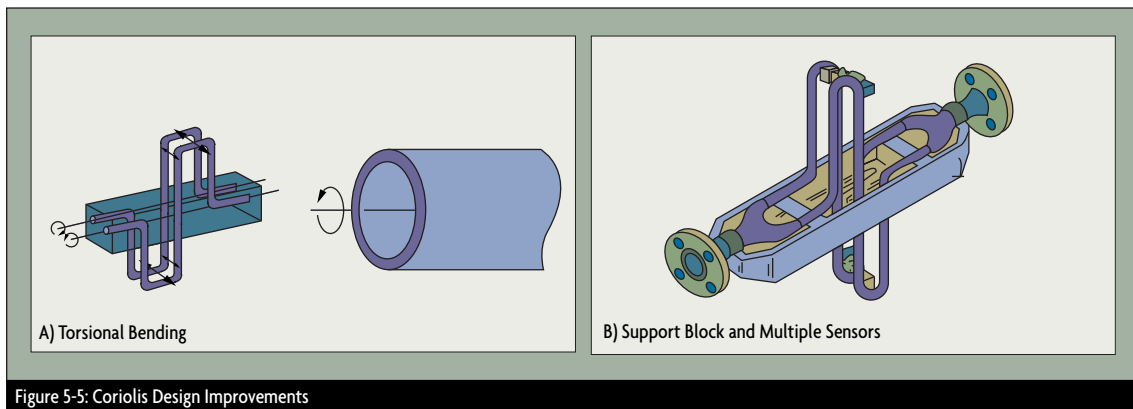

Figure 5-5: Coriolis Design Improvements

when the meter was used on corrosive and erosive services. In addition, the unrecovered head losses were high (sometimes over 50 psid), and accuracy was not high enough to allow users to convert batch processes into continuous ones.

More recent design improvements include the introduction of a variety of new tube shapes, including ones that do not split the flow (Figure 5-3B) and the use of multiple drivers (Figure 5-5A). Thick-walled tubing (five times thicker than early designs), the use of full bore diameters and heavy manifolds to isolate the tube structure from stresses induced from piping connections, and flowtube housings that double as secondary containment vessels have all contributed to improved performance.

In some designs, torsional stresses replaced bending, in order to prevent the concentration of stresses that can lead to tube cracking (Figure 5-5B). In other designs, the effects of pipeline vibration have been minimized by mounting the tube structures transverse to the pipeline.

These improvements increased

that are as reliable and rugged as traditional volumetric flowmeters. The new designs operate at lower fluid velocities (below 10 ft/sec) and at lower pressure drops (under 12 psid), can be installed in any orientation, and provide longer service life on slurry, viscous, corrosive, or erosive services. The tubes are vibrated well below their endurance limits, and typically are made of stainless steel, Hastelloy, and titanium.

• **Interferences**

The effect of the Coriolis force on the vibrating tube is small. Full-scale flow might cause a deflection of only 0.001 inch. To obtain a flow rangeability of 100:1, sensors must be able to detect deflections to an accuracy of 0.000001 inch in industrial environments where the process pressure, temperature, and fluid density are all changing, and where pipe vibration interferes with measurement.

The elasticity of metal tubes changes with temperature; they become more elastic as they get warmer. To eliminate the corresponding measurement error, the

for variations in tube elasticity.

Coriolis mass flowmeters usually are calibrated on water, because the constants are valid for all other liquids. Calibration for density is usually done by filling the tubes with two or more (stagnant) calibration fluids of known densities.

• **Accuracy & Rangeability**

Coriolis meters provide 0.1-2% of rate inaccuracy over a mass flow range of up to 100:1. In general, curved tube designs provide wider rangeability (100:1 to 200:1), while straight-tube meters are limited to 30:1 to 50:1 and their accuracy is lower. Overall meter error is the sum of base inaccuracy and zero-shift error, the error attributable to the irregular output signal generated at zero flow conditions. Zero-shift error becomes the dominant portion of total error at the lower end of the flow range, where the error is between 1% and 2% of rate. Some manufacturers state the overall accuracy as a percentage of rate for the upper portion of the flow range and as a percentage of span for the lower portion, while others state it



as a percentage of rate plus a zero-shift error. There is a fair amount of “specmanship,” and one must read sales literature carefully when comparing different devices.

When used for density measurement, the typical error range of a Coriolis measurement is 0.002-0.0005 g/cc.

Errors are caused by air or gas pockets in the process fluid. In the case of homogeneously dispersed small bubbles, more power is required to vibrate the tubes, whereas, if the gas phase separates from the liquid, a damping effect on tube vibration (and, consequently, error) develops. Small voids also cause noise because of the sloshing of the process liquid in the tubes. Larger

ambient temperature and pressure fluctuations alter these forces, performance may be affected and re-zeroing of the meter may be required.

Variations in the density of the process fluid can affect the frequency transfer function of mechanical systems, necessitating the re-zeroing of older designs to protect them from degraded performance. Because of their tube configurations, newer designs are unaffected by density changes over wide ranges of specific gravity variations.

• **Sizing & Pressure Drop**

Because of the wide rangeability of Coriolis flowmeters (30:1 to as high as 200:1), the same flow can be measured by two or three different sized

Downsizing (using a meter that is smaller than the pipe) is acceptable when the pipe is oversized and the process fluid is clean with a low viscosity. On corrosive, viscous, or abrasive slurry services, downsizing is not recommended. A list of acceptable flow tube sizes and corresponding pressure drops, inaccuracies, and flow velocities can be obtained from software provided by the manufacturer.

Different Coriolis meters incur different pressure drops, but in general they require more than traditional volumetric meters, which usually operate at less than 10 psid. (The yearly electricity cost of pumping 1 gpm across a differential of 10 psid is about \$5 U.S.). This higher head loss is due to the reduced tubing diameter

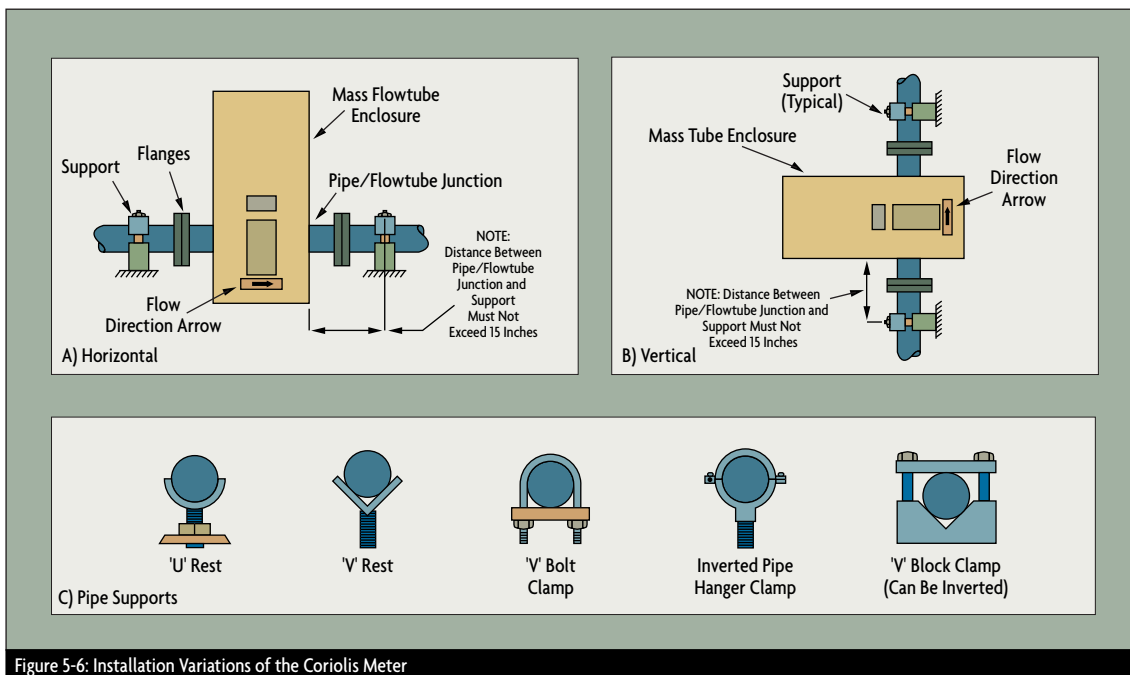

Figure 5-6: Installation Variations of the Coriolis Meter

voids will raise the energy required to vibrate the tubes to excessive levels and may cause complete failure.

Because the flowtube is subjected to axial, bending, and torsional forces during meter operation, if process or

flow tubes. By using the smallest possible meter, one will lower the initial cost and reduce coating build-up, but will increase erosion/corrosion rates and head loss, increasing pumping and operating costs.

and the circuitous path of flow. Besides pumping costs, head loss can be of concern if the meter is installed in a low-pressure system, or if there is a potential for cavitation or flashing, or if the fluid viscosity is very high.

The viscosity of non-Newtonian fluids is a function of their flowing velocity. Dilettante fluids, for example, increase their apparent viscosity (resistance to flow) as their velocity is increased. This apparent viscosity can be drastically higher than their

intrinsically safe circuits between the flow tube and the transmitter. Therefore, the amount of driving power that can be delivered to the flow tube is limited.

When fluid is unloaded from tank trucks, drums, or railroad cars, slug

still remaining homogeneously dispersed. Gas content in low viscosity fluids, like milk, will separate at concentrations as low as 1%.

The cost of an average-sized (under 2 in.) Coriolis flowmeter is between \$4,000 and \$5,000. These

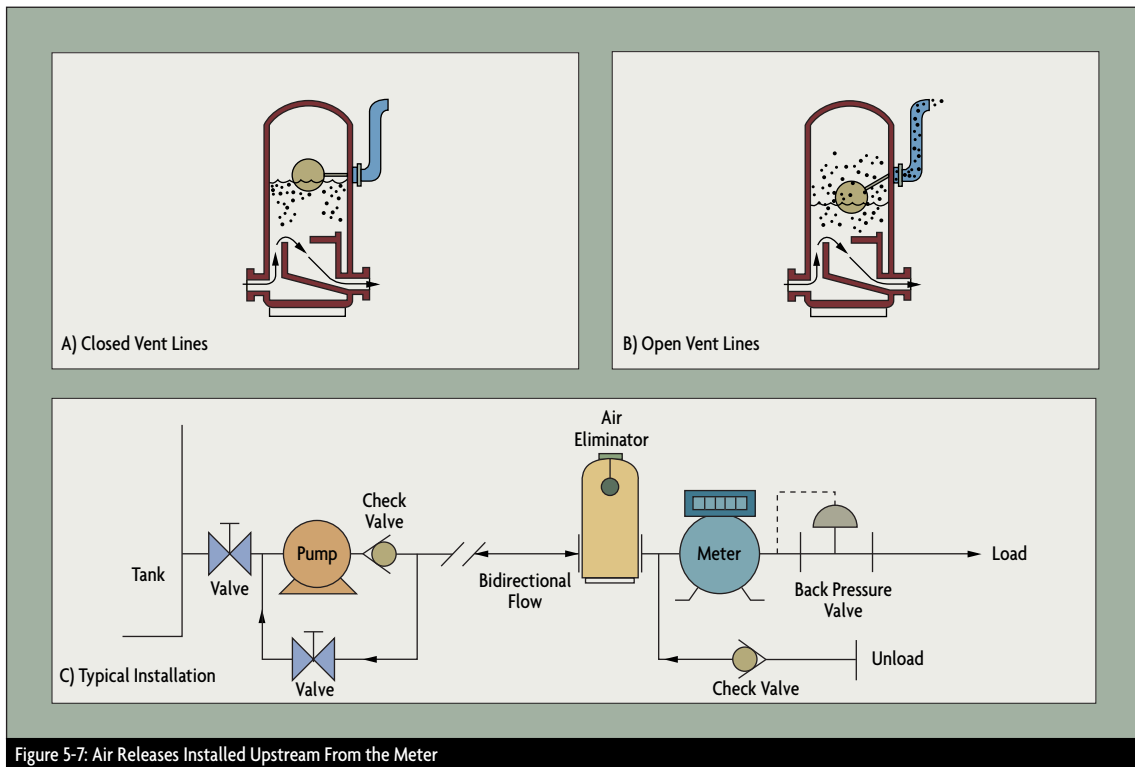

Figure 5-7: Air Releases Installed Upstream From the Meter

viscosity when stagnant. In order to provide suppliers with data on the flowing viscosity in a particular pipe, head loss per foot of pipe (used in pump sizing calculations) can be used as an approximation.

• Applications & Limitations

Coriolis mass flowmeters can detect the flow of all liquids, including Newtonian and non-Newtonian, as well as that of moderately dense gases. Self-draining designs are available for sanitary applications that meet clean-in-place requirements.

Most meters are provided with

flow can occur, making the meter output unpredictable. If a slug-flow recovery feature is provided in the transmitter, it will stop the measurement when slug flow is detected by the excessive drive power drawn or by the drop in process density (reduction in sensor output amplitude).

The amount of air in the process fluid that can be tolerated by a meter varies with the viscosity of the fluid. Liquids with viscosities as high as 300,000 centipoise can be metered with Coriolis meters. Gas content in such highly viscous liquids can be as high as 20% with the small bubbles

mass flowmeters provide short pay-back periods on applications where measurement accuracy lowers production costs (bathing, billing) or where multiple measurements (including density, temperature, pressure) are needed. On the other hand, they may not be competitive when used in simple flow measurement applications where volumetric sensors are sufficient and where repeatability is more important than precision. The ability to extract data on total mass charged, solids rate, percent solids, and viscosity from a single instrument does lower the

total cost of measurement, improves process control, and provides redundancy for other instruments.

Continuous tube designs are generally preferred for slurry and other multi-phase fluid applications. The total flow is divided by splitters in split-tube designs, and the resulting two streams do not have to be at exactly the same mass flow rate to maintain accuracy (they do, however, need to have the same density). Different densities in the two parallel tubes imbalance the system and create measurement errors. Therefore, if there is a secondary phase in the stream, a simple flow splitter may not evenly distribute the flow between the two tubes.

Continuous tube designs are also preferred for measuring fluids that can coat and/or clog the meter.

cleaned by mechanical means, while curved-tube designs are usually washed out using cleaning solutions at velocities in excess of 10 ft/sec. Straight-tube designs also are preferred for sanitary applications due to self-draining requirements.

Long, bent tubes twist more easily than do short, straight tubes and therefore will generate stronger signals under the same conditions. In general, curved-tube designs provide wider rangeability (100:1 to 200:1), while straight-tube meters are limited to 30:1 to 50:1, with lower accuracy.

Straight-tube meters are more immune to pipeline stresses and vibration, are easy to install, require less pressure drop, can be mechanically cleaned, are more compact, and require less room for installation. They are also preferred on services

of tube rupture, particularly if the process fluid is likely to vaporize under such conditions. If that is the case, secondary containment housings can be ordered that enclose the entire flow tube, including its housing. Such secondary containment enclosures can be provided with rupture disks or pressure relief valves, and with drains or vents.

• Installation Recommendations

There are no Reynolds number limitations associated with Coriolis meters. They are also insensitive to velocity profile distortion and swirl. Therefore, there is no requirement for straight runs of relaxation piping upstream or downstream of the meter to condition the flow.

The meter should be installed so that it will remain full of liquid and

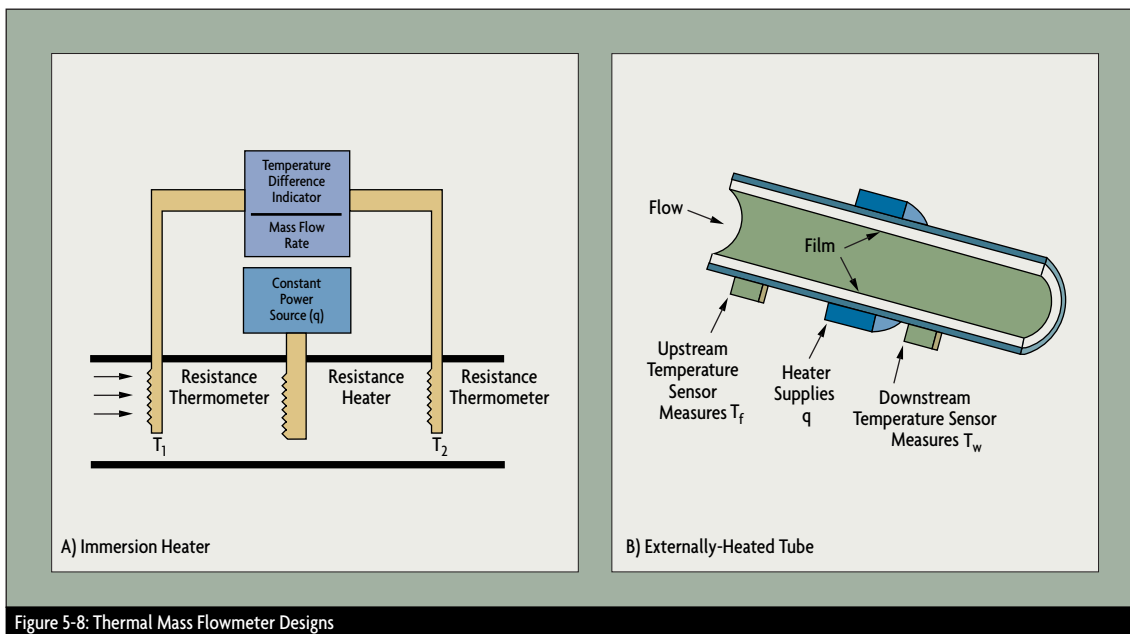

Continuous tubes, if sized to pass the largest solid particles in the process fluid, are less likely to clog and are easier to clean.

Straight-tube designs can be

where the process fluid can solidify at ambient temperatures.

Not all meter housings are designed to withstand and contain the pressurized process fluid in case

so air cannot get trapped inside the tubes. In sanitary installations, the meter must also drain completely. The most desirable installation is in vertical upward flow pipes (Figure 5-6B), but

installations in horizontal lines (Figure 5-6A) are also acceptable. Installations where the flow is downward in a vertical pipe are not recommended.

In newer Coriolis designs, normal pipe vibration should not affect the performance of the Coriolis meter if it is properly supported by the process piping (Figure 5-6C). No special supports or pads are needed for the flow tube, but standard piping supports should be located on either side of the meter. If the installation instructions require special hardware or supports, the particular meter design is likely to be sensitive to vibration, and the pulsation dampeners, flexible connectors, and mounting/clamping attachments recommended by the manufacturer should be carefully installed.

If air bubbles are likely to be present in the process fluid, it is recommended to install an air release upstream of the meter. System design characteristics that can result in the presence of air (and which can often be eliminated at the design stage) include:

- Common piping used for pumping into and out of storage tanks;
- Allowing the formation of a vortex in stirred vessels under low-level conditions;
- Allowing air leakage through packing glands of pumps that develop high vacuums on the suction side (this can occur when pumping from underground storage);
- Vaporization of stagnant process fluid in pipes exposed to the sun;
- High valve pressure drops causing vaporization and flashing;

different materials at different times; and

- Allowing foam formation by high turbulence in high velocity fluids.

It is recommended to install (upstream of the meter) strainers, filters or air/vapor eliminators as required to remove all undesirable secondary phases. Figure 5-7C illustrates an air eliminator installation. Its function is to slow the velocity of the liquid, thereby allowing time for the entrained air to separate and be removed by venting. The rise and fall of the liquid level in the eliminator due to the accumulation of free air closes and opens the vent valve and discharges the air (Figure 5-7A&B).

Prior to zeroing the meter, all air should be removed. This can be accomplished by circulating the

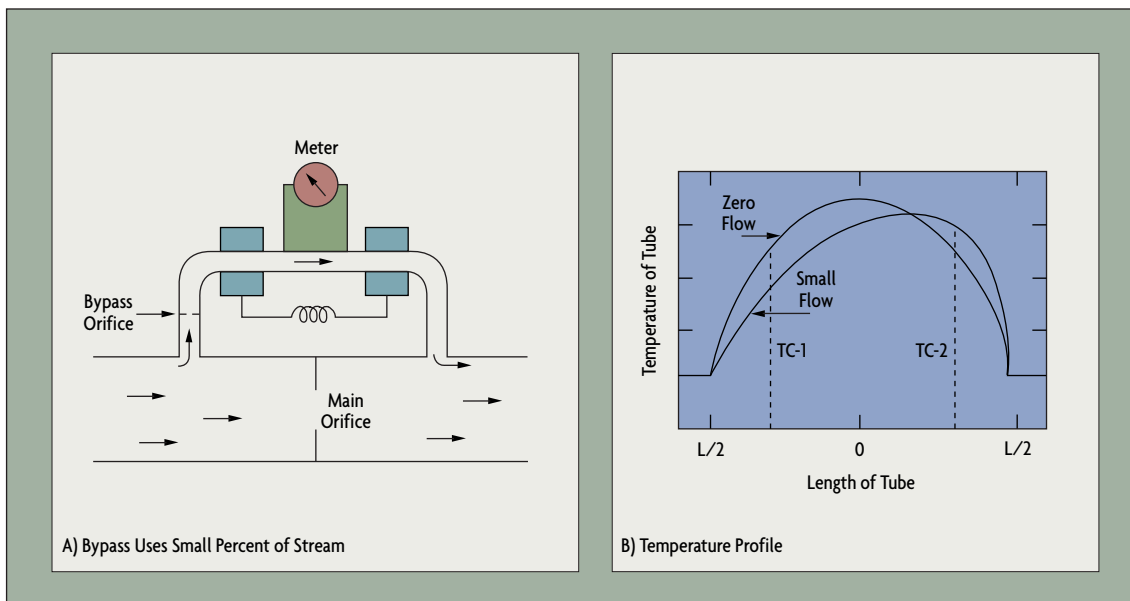

Figure 5-9: The Bypass Flowmeter Design

If your application requires that you install two Coriolis flowmeters in series or mount two Coriolis meters near each other, the manufacturer should be consulted to prevent crosstalk between the two units.

- Allowing the pipe to drain for any reason, including lack of check valves;
- Allowing storage tanks, trucks, or railroad cars to drain completely;
- Using the same pipe for pumping

process fluid through the meter for several minutes at a velocity of approximately 2-6 ft/sec. On batching or other intermittent flow applications, the meter should stay flooded so that it does not need to be

repurged. All meters should be so installed so they can be zeroed while filled with liquid.

When zeroing the meter, any associated pumps or other equipment should be running so that their

standard of higher accuracy, such as a dead-weight calibrated weigh tank. Before Coriolis meters, the reference standard was expected to be an order of magnitude more accurate than the meter being calibrated;

must be installed by the manufacturer.

When flowmetering is not required, the Coriolis meter can be used solely as a densitometer. In that case, to minimize cost, usually a small (1/2 in.) meter is installed in a by-pass line. Such a

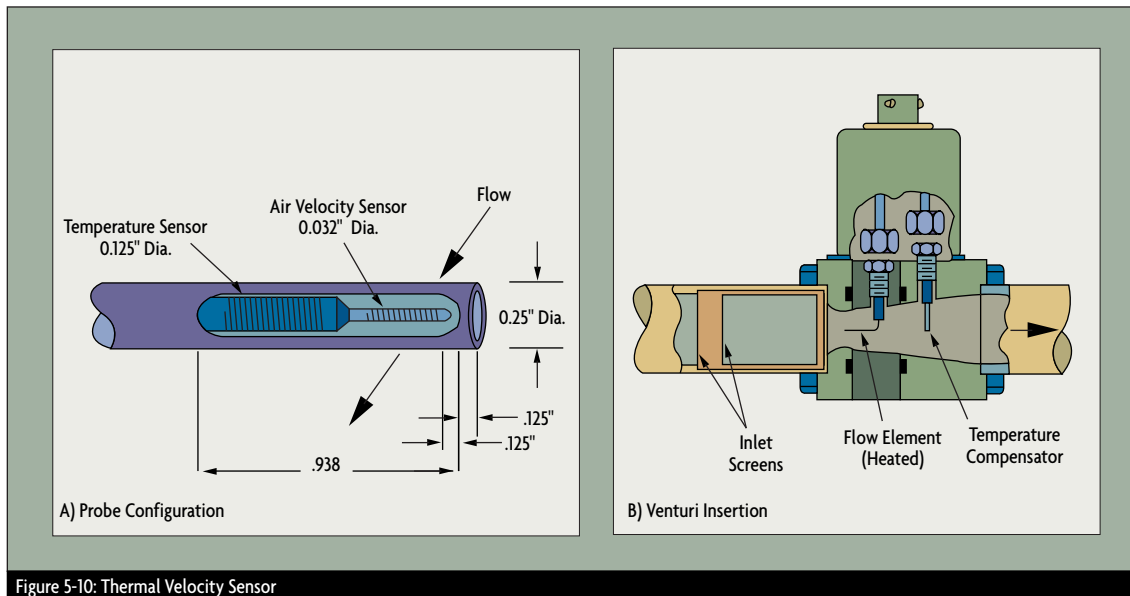

Figure 5-10: Thermal Velocity Sensor

noise can be zeroed out. This can be achieved in most cases by locating a shut-off valve downstream of the meter and either operating the pump with its discharge blocked, which is acceptable with centrifugal pumps for a short period, or by opening the pump bypass on positive displacement pumps. Valves used in zeroing the meter should provide tight shut-off; double-seated valves are preferred.

Meters that are expected to be calibrated in-line must be provided with block and bypass valves so that the reference standard (master) meter can be installed and disconnected without interrupting the process. The requirements for in-line calibration (for ISO 9000 verification) consist of comparing the output of the meter against a reference

however, due to the high accuracy of Coriolis meters, this is rare.

In less critical installations (where weigh tanks are not used), volumetric provers or master meters (typically another Coriolis or a turbine meter calibrated at a flow laboratory) are used. When a volumetric reference is used in calibrating a mass flowmeter, the fluid density must be very precisely determined.

Control valves should be installed downstream of the meter to increase the back-pressure on the meter and lower the probability of cavitation or flashing.

When the process fluid must be held at higher temperatures, some Coriolis meters can be supplied with steam jackets. As an alternative, electrical heating tape can be added to the housing. Jackets or heating tapes

configuration is acceptable only in clean services that will not clog the small bore of the meter. In addition, a restriction must be placed in the main piping (between the by-pass taps) to ensure a flow through the meter.

### Thermal Mass Flowmeters

Thermal mass flowmeters also measure the mass flowrate of gases and liquids directly. Volumetric measurements are affected by all ambient and process conditions that influence unit volume or indirectly affect pressure drop, while mass flow measurement is unaffected by changes in viscosity, density, temperature, or pressure.

Thermal mass flowmeters are often used in monitoring or controlling mass-related processes such as chemical reactions that depend on

the relative masses of unreacted ingredients. In detecting the mass flow of compressible vapors and gases, the measurement is unaffected

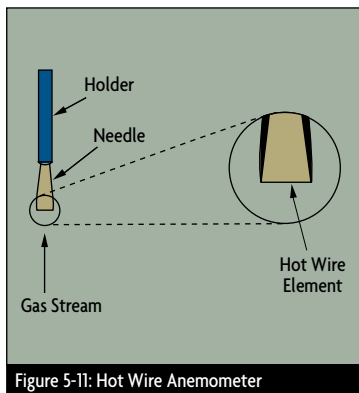

Figure 5-11: Hot Wire Anemometer

by changes in pressure and/or temperature. One of the capabilities of thermal mass flowmeters is to accurately measure low gas flowrates or low gas velocities (under 25 ft. per minute)—much lower than can be detected with any other device.

Thermal flowmeters provide high rangeability (10:1 to 100:1) if they are operated in constant-temperature-difference mode. On the other hand, if heat input is constant, the ability to detect very small temperature differences is limited and both precision and rangeability drop off. At normal flows, measurement errors are usually in the 1-2% full scale range.

This meter is available in high pressure and high temperature designs, and in special materials including glass, Monel, and Teflon®. Flow-through designs are used to measure small flows of pure substances (heat capacity is constant if a gas is pure), while bypass and probe-type designs can detect large flows in ducts, flare stacks, and dryers.

• Theory of Operation

Thermal mass flowmeters are most often used for the regulation of low

gas flows. They operate either by introducing a known amount of heat into the flowing stream and measuring an associated temperature change, or by maintaining a probe at a constant temperature and measuring the energy required to do so. The components of a basic thermal mass flowmeter include two temperature sensors and an electric heater between them. The heater can protrude into the fluid stream (Figure 5-8A) or can be external to the pipe (Figure 5-8B).

In the direct-heat version, a fixed amount of heat (q) is added by an electric heater. As the process fluid flows through the pipe, resistance temperature detectors (RTDs) measure the temperature rise, while the amount of electric heat introduced is held constant.

The mass flow (m) is calculated on

$$m = Kq / (C_p (T_2 - T_1))$$

• Heated-Tube Design

Heated-tube flowmeters were developed to protect the heater and sensor elements from corrosion and any coating effects of the process. By mounting the sensors externally to the piping (Figure 5-8B), the sensing elements respond more slowly and the relationship between mass flow and temperature difference becomes nonlinear. This nonlinearity results from the fact that the heat introduced is distributed over some portion of the pipe's surface and transferred to the process fluid at different rates along the length of the pipe.

The pipe wall temperature is highest near the heater (detected as



All-in-one mass flow controller provides both measurement and control of relatively low mass flow rates.

the basis of the measured temperature difference ( $T_2 - T_1$ ), the meter coefficient (K), the electric heat rate (q), and the specific heat of the fluid ( $C_p$ ), as follows:

$T_w$  in Figure 5-8B), while, some distance away, there is no difference between wall and fluid temperature. Therefore, the temperature of the unheated fluid ( $T_f$ ) can be detected by

measuring the wall temperature at this location further away from the heater. This heat transfer process is non-linear, and the corresponding equation differs from the one above as follows:

$$m^{0.8} = Kq / (C_p (T_w - T_f))$$

This flowmeter has two operating modes: one measures the mass flow by keeping the electric power input constant and detecting the temperature rise. The other mode holds the temperature difference constant and measures the amount of electricity

of the process fluid must stay constant when using this design.

• **Bypass-Type Design**

The bypass version of the thermal mass flowmeter was developed to measure larger flow rates. It consists of a thin-walled capillary tube (approximately 0.125 in diameter) and two externally wound self-heating resistance temperature detectors (RTDs) that both heat the tube and measure the resulting temperature rise (Figure 5-9A). The meter is placed in a bypass around a restriction in the main pipe and is sized to operate in

the speed of response of the measurement. On the other hand, because of the small size, filters are necessary to prevent plugging. One serious limitation is the high pressure drop (up to 45 psi) needed to develop laminar flow. This is typically acceptable only for high pressure gas applications where the pressure needs to be reduced in any case.

This is a low accuracy (2% full scale), low maintenance, and low cost flowmeter. Electronic packages within the units allow for data acquisition, chart recording, and computer interfacing. These devices are popular

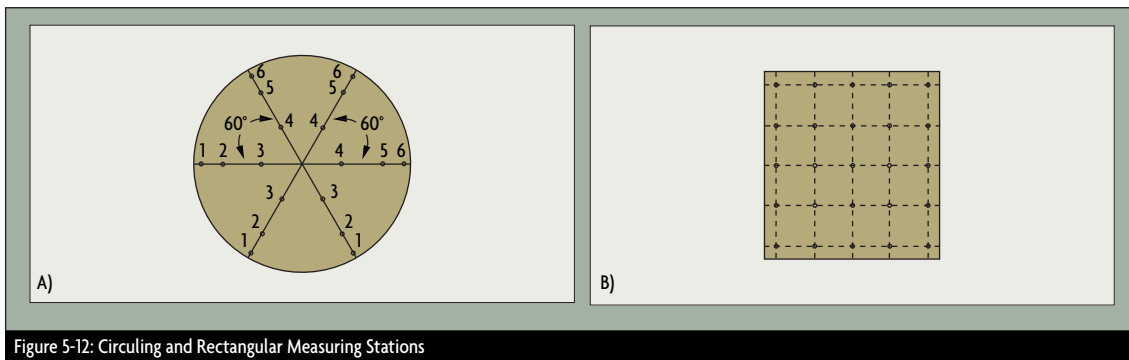

Figure 5-12: Circuling and Rectangular Measuring Stations

needed to maintain it. This second mode of operation provides for a much higher meter rangeability.

Heated-tube designs are generally used for the measurement of clean (e.g., bottled gases) and homogeneous (no mixtures) flows at moderate temperature ranges. They are not recommended for applications where either the fluid composition or its moisture content is variable, because the specific heat ( $C_p$ ) would change. They are not affected by changes in pressure or temperature. Advantages include wide rangeability (the ability to measure very low flows) and ease of maintenance. The temperature difference (or heater power), flowmeter geometry, thermal capacity, specific heat, and viscosity

the laminar flow region over its full operating range.

When there is no flow, the heaters raise the bypass-tube temperature to approximately 160°F above ambient temperature. Under this condition, a symmetrical temperature distribution exists along the length of the tube (Figure 5-9B). When flow is taking place, the gas molecules carry the heat downstream and the temperature profile is shifted in the direction of the flow. A Wheatstone bridge connected to the sensor terminals converts the electrical signal into a mass flow rate proportional to the change in temperature.

The small size of the bypass tube makes it possible to minimize electric power consumption and to increase

in the semiconductor processing industry. Modern day units are also available as complete control loops, including a controller and automatic control valve.

• **Air Velocity Probes**

Probe-style mass flowmeters are used to measure air flows and are insensitive to the presence of moderate amounts of dust. They maintain a temperature differential between two RTDs mounted on the sensor tube. The upper sensor measures the ambient temperature of the gas (Figure 5-10A) and continuously maintains the second RTD (near the tip of the probe) at 60°F above ambient. The higher the gas velocity, the more current is required to maintain



the temperature differential.

Another version of the velocity probe is the venturi-type thermal mass flowmeter, which places a heated mass flow sensor at the minimum diameter of a venturi flow element and a temperature compensation probe downstream (Figure 5-10B). An inlet screen mixes the flow to make the temperature uniform. This design is used for both gas and liquid measurement (including slurries), with flow range a function of the size of the venturi. Pressure drop is relatively low and precision is dependent upon finding the proper probe insertion depth.

A flow switch version is also available that contains two temperature sensors in the tip. One of the sensors is heated and the temperature difference is a measure of velocity. The switch can be used to detect high or low flow within 5%.

• **Uses & Limitations**

Thermal mass flowmeters can have very high rangeability and reasonable accuracy, but they also have serious limitations. Potential problems include the condensation of moisture (in saturated gases) on the temperature detector. Such condensation will cause the thermometer to read low and can lead to corrosion. Coating or material build-up on the sensor also will inhibit heat transfer and cause the meter to read low. Additional potential sources of error include variations in the specific heat caused by changes in the gas's composition.

Some common gas-flow applications for thermal mass flowmeters include combustion air measurement in large boilers, semiconductor process gas measurement, air sampling in nuclear power plants, process gas measurements in the

chemical and petrochemical industries, research and development applications, gas chromatography, and filter and leak testing. While hot-wire anemometers are best suited for clean gases at low velocities, venturi meters can also be considered for some liquid (including slurry) flow

rate of cooling corresponds to the mass flowrate.

The circuitry of the heated sensing element is controlled by one of two types of solid-state electronic circuits: constant-temperature or constant-power. The constant-temperature sensor maintains a constant temperature



Air velocity probe provides 1.5% accuracy for local flow rate measurement.

applications. Thermal mass flowmeters are well suited for high rangeability measurements of very low flows, but also can be used in measuring large flows such as combustion air, natural gas, or the distribution of compressed air.

**Hot-Wire Anemometers**

The term anemometer was derived from the Greek words *anemos*, “wind,” and *metron*, “measure.” Mechanical anemometers were first developed back in the 15th century to measure wind speed.

A hot-wire anemometer consists of an electrically heated, fine-wire element (0.00016 inch in diameter and 0.05 inch long) supported by needles at its ends (Figure 5-11). Tungsten is used as the wire material because of its strength and high temperature coefficient of resistance. When placed in a moving stream of gas, the wire cools; the

differential between a heated sensor and a reference sensor; the amount of power required to maintain the differential is measured as an indication of the mass flow rate.

Constant-temperature anemometers are popular because of their high-frequency response, low electronic noise level, immunity from sensor burnout when airflow suddenly drops, compatibility with hot-film sensors, and their applicability to liquid or gas flows.

Constant-power anemometers do not have a feedback system. Temperature is simply proportional to flowrate. They are less popular because their zero-flow reading is not stable, temperature and velocity response is slow, and temperature compensation is limited.

• **Air Duct Traversing**

Anemometers are widely used for air duct balancing. This is accomplished

by placing multiple anemometers in a cross-section of the duct or gas pipe and manually recording the velocity readings at numerous points. The mass flow rate is obtained by calculating the mean velocity and multiplying this by the density and by the cross-sectional area measurement of the duct.

For cylindrical ducts, the log-linear method of traversing provides the highest accuracy because it takes into account the effects of friction along the walls of the duct. Because of the number of measurements (Figure 5-12), air duct traversing is a time-consuming task. Microprocessor-based anemometers are available to automate this procedure.

Because of the small size and fragility of the wire, hot-wire anemometers are susceptible to dirt build-up and breakage. A positive consequence of their small mass is fast speed of response. They are widely used in HVAC and ventilation applications. Larger and more rugged anemometers are also available for more demanding industrial applications. To ensure the proper formation of the velocity profile, a straight duct section is usually provided upstream of the anemometer station (usually 10 diameters long). A conditioning nozzle is used to eliminate boundary layer effects. If there is no room for the straight pipe section, a honeycomb flow straightener can be incorporated into the sensor assembly. 

## References & Further Reading

- *OMEGA Complete Flow and Level Measurement Handbook and Encyclopedia*<sup>®</sup>, OMEGA Press, 1995.
- *OMEGA Volume 29 Handbook & Encyclopedia, Purchasing Agents Edition*, OMEGA Press, 1995.
- “Air Elimination Techniques for Accurate Liquid Measurement,” J. R. Chester, *Mechanical Engineering*, February 1983.
- “Application and Installation Guidelines for Volumetric and Mass Flowmeters,” D. Ginesi and C. Annarummo, *ISA Transactions*, Instrument Society of America, 1994.
- *Automated Process Control Electronics*, John Harrington, Delmar Publishing Inc., 1989.
- “Coriolis for the Masses,” G. J. Blickley, *Control Engineering*, June 1995.
- “Coriolis Mass Flowmeter is Ready for the Tough Jobs,” W. Chin, *I&CS*, February 1992.
- “Field Proving Coriolis Mass Flowmeter,” R. Harold and C. Strawn, *ISA/91 Proceedings*, Instrument Society of America, 1991.
- *Flow Measurement*, D.W. Spitzer (editor), Instrument Society of America, 1991.
- “Flow Sensing: The Next Generation,” D. Ginesi, *Control Engineering*, November 1997.
- *Instrument Engineers’ Handbook*, Bela Liptak, CRC Press, 1995.
- *Instrumentation for Process Measurement and Control*, 3rd edition, Norman A. Anderson, Chilton Co., 1980.
- *Instruments of Science*, Robert Bud and Deborah Jean Warner, Garland Publishing Inc., 1998.
- “Metering Mass Flow,” H. van der Bent, *Process Engineering*, May 1993.
- “On-line Viscosity Measurement with Coriolis Mass Flowmeters,” P. Kalotry and D. Schaffer, *ISA/91 Proceedings*, Instrument Society of America, 1991.
- *Process/Industrial Instruments and Controls Handbook*, 4th edition, Douglas M. Considine, McGraw-Hill, 1993.
- “Technical Application Guide to Mass Flow Measurement,” Wayne Shannon, Magnetrol International, 1998.
- *The McGraw-Hill Encyclopedia of Science and Technology*, 8th edition, John H. Zifcak, McGraw-Hill, 1997.

- Level Sensor Selection
- Boiling & Cryogenic Fluids
- Sludge, Foam, & Molten Metals

# A Level Measurement Orientation

On the 28th of March, 1979, thousands of people fled from Three Mile Island (near Harrisburg, PA) when the cooling system of a nuclear reactor failed. This dangerous situation

into the tank or should it be completely external?

- Should the sensor detect the level continuously or will a point sensor be adequate?
- Can the sensor come in contact

liquid layers, it is advisable to consult not only Table 4, but other recommendations, such as Table 5.

If it is found that a number of level detector designs can satisfy the requirements of the application, one should also consider the traditions or preferences of the particular plant or the particular process industry, because of user familiarity and the availability of spare parts. For example, the oil industry generally prefers displacement-type level sensors, while the chemical industry favors differential pressure (d/p) cells. (The petroleum industry will use d/p cells when the span exceeds 60-80 in.)

If the tank is agitated, there is often no space in which to insert probe-type sensors. Plus, because the liquid surface is not flat, sonic, ultrasonic, or radar devices typically cannot be used, either. Even with displacer or d/p sensors, agitation can cause the level signal to cycle. These pulses can be filtered out by first determining the maximum rate at

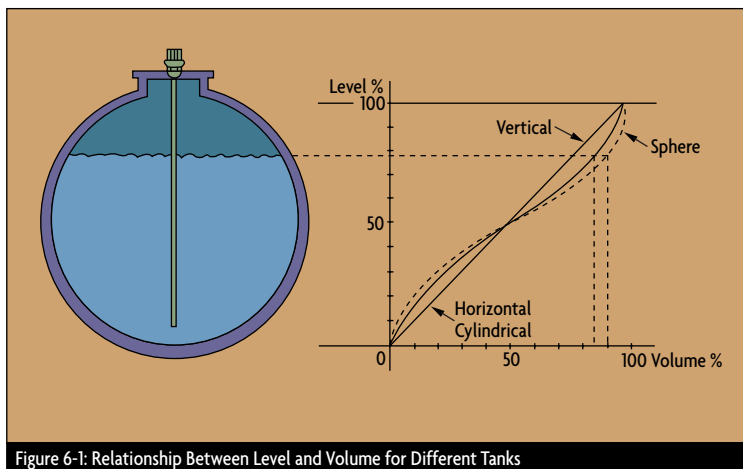

Figure 6-1: Relationship Between Level and Volume for Different Tanks

developed because the level controls turned off the coolant flow to the reactor when they detected the presence of cooling water near the top of the tank. Unfortunately, the water reached the top of the reactor vessel not because there was too much water in the tank, but because there was so little that it boiled and swelled to the top. From this example, we can see that level measurement is more complex than simply the determination of the presence or absence of a fluid at a particular elevation.

## Level Sensor Selection

When determining what type of level sensor should be used for a given application, there are a series of questions that must be answered:

- Can the level sensor be inserted

with the process fluid or must it be located in the vapor space?

- Is direct measurement of the level needed or is indirect detection of hydrostatic head (which responds to changes in both level and density) acceptable?
- Is tank depressurization or process shut-down acceptable when sensor removal or maintenance is required?

By evaluating the above choices, one will substantially shorten the list of sensors to consider. The selection is further narrowed by considering only those designs that can be provided in the required materials of construction and can function at the required accuracy, operating temperature, etc. (Table 4). When the level to be measured is a solid, slurry, foam, or the interface between two

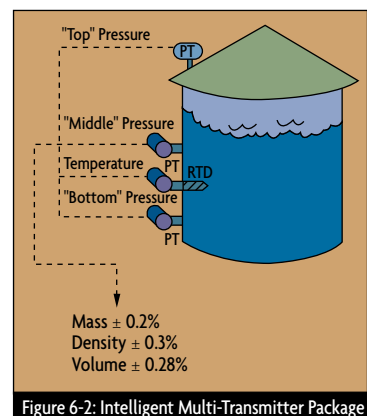

Figure 6-2: Intelligent Multi-Transmitter Package

which the level can change (due to filling or discharging) and disregarding any change that occurs faster

**Table 4: Orientation Table for Selecting Level Sensors**

TYPE	MAX. TEMP. (°F)	AVAILABLE AS NONCONTACT	INACCURACY (1 in. = 25.4 mm)	APPLICATIONS								LIMITATIONS	
				LIQUIDS				SOLIDS					
				CLEAN	VISCOUS	SLURRY/SLUDGE	INTERFACE	FOAM	POWDER	CHUNKY	STICKY		
Air Bubblers	UL		1-2% FS	G	F	P	F						Introduces foreign substance into process; high maintenance
Capacitance	2,000		1-2% FS	G	F-G	F	G-L	P	F	F	P		Interface between conductive layers and detection of foam is a problem
Conductivity Switch	1,800		1/8 in	F	P	F	L	L	L	L	L		Can detect interface only between conductive and nonconductive liquids. Field effect design for solids
Diaphragm	350		0.5% FS	G	F	F			F	F	P		Switches only for solid service
Differential Pressure	1,200		0.1% AS	E	G-E	G	P						Only extended diaphragm seals or repeaters can eliminate plugging. Purging and sealing legs are also used
Displacer	850		0.5% FS	E	P	P	F-G						Not recommended for sludge or slurry service
Float	500		1% FS	G	P	P	F						Moving parts limit most designs to clean service. Only preset density floats can follow interfaces
Laser	UL	X	0.5 in	L	G	G		F	F	F	F		Limited to cloudy liquids or bright solids in tanks with transparent vapor spaces
Level Gages	700		0.25 in	G	F	P	F						Glass is not allowed in some processes
Microwave Switches	400	X	0.5 in	G	G	F	G		G	G	F		Thick coating is a limitation
Optical Switches	260	X	0.25 in	G	F	E	F-G	F	F	P	F		Refraction-type for clean liquids only; reflection-type requires clean vapor space
Radar	450	X	0.12 in	G	G	F	P		P	F	P		Interference from coating, agitator blades, spray, or excessive turbulence
Radiation	UL	X	0.25 in	G	E	E	G	F	G	E	E		Requires NRC license
Resistance Tape	225		0.5 in	G	G	G							Limited to liquids under near-atmospheric pressure and temperature conditions
Rotating Paddle Switch	500		1 in						G	F	P		Limited to detection of dry, non-corrosive, low-pressure solids
Slip Tubes	200		0.5 in	F	P	P							An unsafe manual device
Tape-Type Level Sensors	300		0.1 in	E	F	P	G		G	F	F		Only the inductively coupled float is suited for interface measurement. Float hangup is a potential problem with most designs
Thermal	850		0.5 in	G	F	F	P	F					Foam and interface detection is limited by the thermal conductivities involved
TDR/PDS	221		3 in	F	F	F			G	G	F		Limited performance on sticky process materials
Ultrasonic	300	X	1% FS	F-G	G	G	F-G	F	F	F	G		Presence of dust, foam, dew in vapor space; sloping or fluffy process material interferes with performance
Vibrating Switches	300		0.2 in	F	G	G	F		F	G	G		Excessive material buildup can prevent operation

TDR = Time Domain Reflectometry F = Fair  
 PDS = Phase Difference Sensors G = Good  
 AS = in % of actual span L = Limited  
 E = Excellent P = Poor  
 FS = in % of full scale UL = Unlimited

than that.

The relationship between level and tank volume is a function of the cross-sectional shape of the tank. With vertical tanks, this relationship is linear, while with horizontal or spherical vessels, it is a non-linear relationship (Figure 6-1).

If the level in a tank is to be inferred using hydrostatic pressure measurement, it is necessary to use

multi-transmitter systems when it is desirable to:

- Detect the true level, while either the process temperature or density varies;
- Measure both level and density; and
- Measure the volume and the mass (weight) in the tank.

By measuring one temperature and three pressures, the system shown in

Figure 6-2 is capable of simultaneously measuring volume (level), mass (weight), and density, all with an accuracy of 0.3% of full span.

### Boiling & Cryogenic Fluids

When a d/p cell is used to measure the level in a steam drum, a reverse-acting transmitter is usually installed (Figure 6-3). An uninsulated condensing chamber is used to connect the

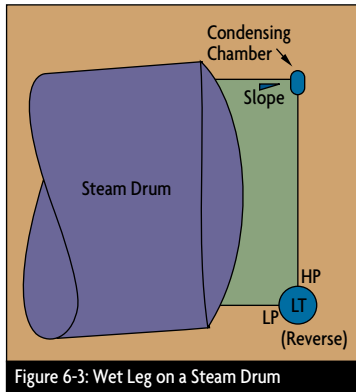

Figure 6-3: Wet Leg on a Steam Drum

high pressure (HP) side of the d/p cell to the vapor space on the top of the drum. The steam condenses in this chamber and fills the wet leg with ambient temperature water, while the low pressure (LP) side of the d/p cell detects the hydrostatic head of the boiling water inside the drum. The output of the d/p cell

reflects the amount of water in the drum. Output rises as the mass of water in the drum drops (because the steaming rate and the associated swelling increase). It is for this reason that a reverse acting d/p cell is recommended for this application.

When the process fluid is liquid nitrogen (or some other cryogenic material), the tank is usually surrounded by a thermally insulated and evacuated cold box. Here, the low pressure (LP) side of a direct acting d/p cell is connected to the vapor space above the cryogenic liquid (Figure 6-4). As the liquid nitrogen approaches the HP side of the d/p cell (which is at ambient temperature outside the cold box), its temperature rises. When the temperature reaches the boiling point of nitrogen, it will boil and,

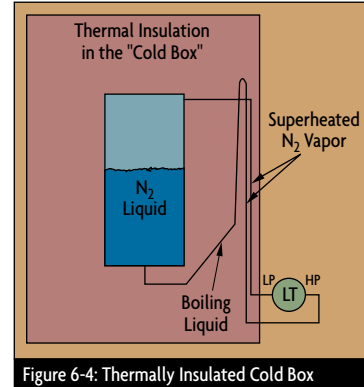

Figure 6-4: Thermally Insulated Cold Box

from that point on, the connecting line will be filled with nitrogen vapor. This can cause noise in the level measurement. To protect against this, the liquid filled portion of the connecting line should be sloped back towards the tank. The cross-section of the line should be large (about 1 inch in diameter) to

Table 5: The Applicability of Level Sensors for Different Services

	LIQUIDS		LIQUID/LIQUID INTERFACE		FOAM		SLURRY		SUSPENDED SOLIDS		POWDERY SOLIDS		GRANULAR SOLIDS		CHUNKY SOLIDS		STICKY MOIST SOLIDS	
	P	C	P	C	P	C	P	C	P	C	P	C	P	C	P	C	P	C
Beam Breaker	-	-	-	-	2	-	-	-	-	-	1	-	1	-	3	-	1	-
Bubbler	1	1	-	-	-	-	3	2	-	-	-	-	-	-	-	-	-	-
Capacitance	1	1	1	1	1	2	1	2	-	-	2	2	1	2	2	2	1	2
Conductive	1	-	2	-	1	-	1	-	-	-	3	-	3	-	3	-	1	-
Differential Pressure	2	1	2	2	-	-	2	2	-	-	3	3	-	-	-	-	-	-
Electromechanical																		
Diaphragm	1	1	2	-	-	-	2	2	-	-	1	3	1	-	3	-	2	3
Displacer	1	2	2	2	-	-	3	2	-	-	-	-	-	-	-	-	-	-
Float	1	-	2	-	-	-	3	-	-	-	-	-	-	-	-	-	-	-
Float/Tape	3	1	-	-	-	-	3	-	-	-	-	-	-	-	-	-	-	-
Paddlewheel	-	-	-	-	-	-	3	-	-	-	2	-	1	-	3	-	2	-
Weight/Cable	3	1	-	-	-	-	1	-	1	-	1	-	1	-	1	-	1	-
Gages																		
Glass	1	1	2	2	3	3	3	3	-	-	-	-	-	-	-	-	-	-
Magnetic	1	1	-	-	3	3	3	3	-	-	-	-	-	-	-	-	-	-
Inductive	-	-	-	-	-	-	2	-	-	-	2	2	2	2	2	2	3	3
Microwave	1	1	-	-	-	-	1	1	-	-	1	2	1	1	1	1	1	1
Radiation	1	1	-	-	-	-	1	1	-	-	1	1	1	1	1	1	1	1
Sonic Echo																		
Sonar	-	-	2	2	-	-	-	3	1	1	-	-	-	-	-	-	-	-
Sonic	1	1	3	3	-	-	1	1	2	2	-	3	1	1	1	1	2	1
Ultrasonic	1	2	2	2	-	-	1	2	1	1	-	3	2	2	1	2	2	2
Thermal	1	-	1	-	2	-	2	-	-	-	-	-	-	-	-	-	-	-
Vibration	2	-	3	-	-	-	2	-	1	-	1	-	1	-	2	-	1	-

minimize the turbulence caused by the simultaneous boiling and re-condensing occurring at the liquid-vapor interface.

### Sludge, Foam, & Molten Metals

Many process fluids are aggressive or difficult to handle and it's best to

episode, an automatic washing spray is activated.

When the sludge or slurry level is detected continuously, one of the goals is to eliminate dead-ended cavities where the sludge might settle. In addition, all surfaces which are exposed to the process fluid should

period of time, one aims to keep the foam level below a maximum. In other processes, it is desirable to separately control both the liquid level beneath the foam and the thickness of the foam. In the paper industry, beta radiation detectors are used for such applications (Kraft processing), while other industries detect the degree of foaming indirectly (by measuring related variables, such as heat input or vapor flow), or they use capacitance, conductivity, tuning fork, optical, or thermal switches, all provided with automatic washers.

Measuring the level of molten glass or metals is another special application. The most expensive (but also most accurate) technique available is proximity capacitance-based level measurement, which can provide a resolution of 0.1 mm over a range of 6 in. Laser-based systems can provide even better resolution from distances up to 2 ft. If such high resolution is not required and cost is a concern, one can make a float out of refractory material and attach a linear variable differential transformer (LVDT), or make a bubbler tube out of refractory material and bubble argon or nitrogen through it. T

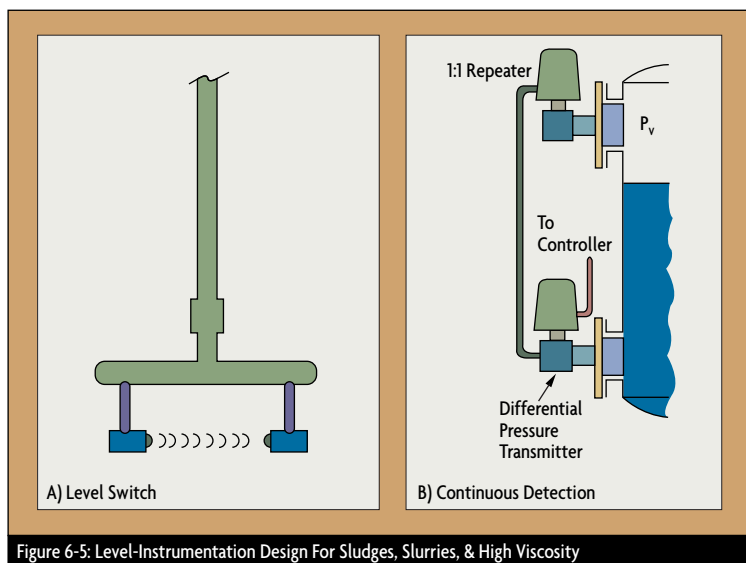

Figure 6-5: Level-Instrumentation Design For Sludges, Slurries, & High Viscosity

avoid physical contact with them. This can be accomplished by placing the level sensor outside the tank (weighing, radiation) or locating the sensor in the vapor space (ultrasonic, radar, microwave) above the process fluid. When these options are not available or acceptable, one must aim to minimize maintenance and physical contact with the process fluid.

When the process fluid is a sludge, slurry, or a highly viscous polymer, and the goal is to detect the level at one point, the design shown in Figure 6-5A is commonly considered. The ultrasonic or optical signal source and receiver typically are separated by more than six inches so that the process fluid drains freely from the intervening space. After a high-level

be covered with Teflon®. Figure 6-5B shows such an installation, employing Teflon®-coated extended diaphragms to minimize material buildup.

In strippers, where the goal is to drive off the solvent in the shortest

### References & Further Reading

- OMEGA Complete Flow and Level Measurement Handbook and Encyclopedia®, OMEGA Press, 1995.
- OMEGA Volume 29 Handbook & Encyclopedia, Purchasing Agents Edition, OMEGA Press, 1995.
- Instrument Engineer's Handbook, Bela G. Liptak, editor, CRC Press, 1995.
- Instrumentation for Process Measurement and Control, Third Edition, N. A. Anderson, Chilton, 1980.
- Measurement and Control of Liquid Level, C. H. Cho, Instrument Society of America, 1982.
- Principles of Industrial Measurement for Control Applications, E. Smith, Instrument Society of America, 1984.

# Pressure/Density Level Instrumentation

One of the primary principles underlying industrial level measurement is that different materials and different phases of the same material have different densities. This basic law of nature can be utilized to measure level via differential pressure (that at the bottom of the tank relative to that in the vapor space or to atmospheric pressure) or via a float or displacer that depends on the density differences between phases.

Level measurement based on pressure measurement is also referred to as hydrostatic tank gaging (HTG). It works on the principle that the difference between the two pressures (d/p)

level (accurate to better than 1%) over wide ranges, as long as the density of the liquid is constant. When a d/p cell is used, it will cancel out the effects of barometric pressure variations because both the liquid in the tank and the low pressure side of the d/p cell are exposed to the pressure of the atmosphere (Figure 7-1B). Therefore, the d/p cell reading will represent the tank level.

## Dry & Wet Leg Designs

When measuring the level in pressurized tanks, the same d/p cell designs (motion balance, force balance, or electronic) are used as on open tanks. It is assumed that the weight of the

leg enables the d/p cell to compensate for the pressure pushing down on the liquid's surface, in the same way as the effect of barometric pressure is canceled out in open tanks.

It is important to keep this reference leg dry because accumulation of condensate or other liquids would cause error in the level measurement. When the process vapors condense at normal ambient temperatures or are corrosive, this reference leg can be filled to form a wet leg. If the process condensate is corrosive, unstable, or undesirable to use to fill the wet leg, this reference leg can be filled with an inert liquid.

In this case, two factors must be

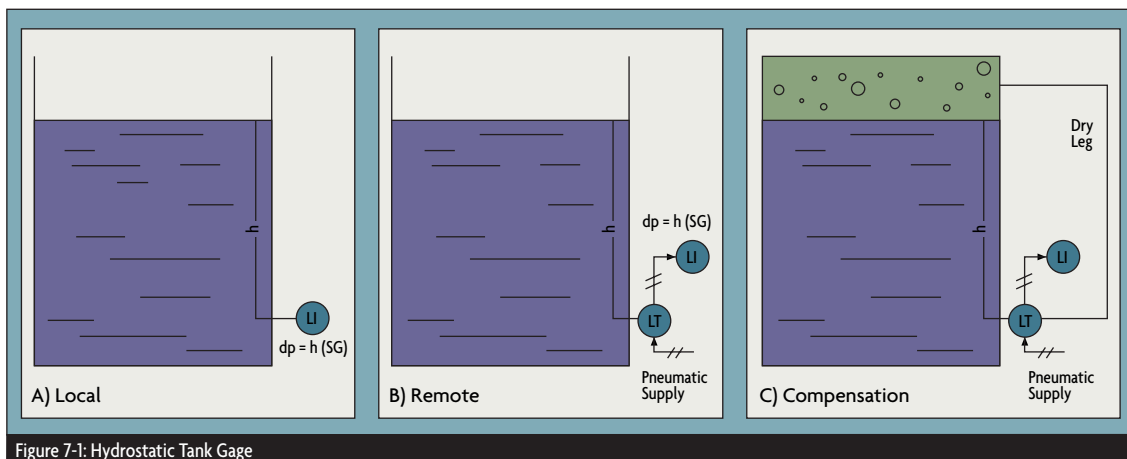

Figure 7-1: Hydrostatic Tank Gage

is equal to the height of the liquid ( $h$ , in inches) multiplied by the specific gravity ( $SG$ ) of the fluid (see Figure 7-1):

$$d/p = h (SG)$$

By definition, specific gravity is the liquid's density divided by the density of pure water at 68° F at atmospheric pressure. A pressure gage or d/p cell can provide an indication of

vapor column above the liquid is negligible. On the other hand, the pressure in the vapor space cannot be neglected, but must be relayed to the low pressure side of the d/p cell. Such a connection to the vapor space is called a dry leg, used when process vapors are non-corrosive, non-plugging, and when their condensation rates, at normal operating temperatures, are very low (Figure 7-1C). A dry

leg enables the d/p cell to compensate for the pressure pushing down on the liquid's surface, in the same way as the effect of barometric pressure is canceled out in open tanks. It is important to keep this reference leg dry because accumulation of condensate or other liquids would cause error in the level measurement. When the process vapors condense at normal ambient temperatures or are corrosive, this reference leg can be filled to form a wet leg. If the process condensate is corrosive, unstable, or undesirable to use to fill the wet leg, this reference leg can be filled with an inert liquid. In this case, two factors must be



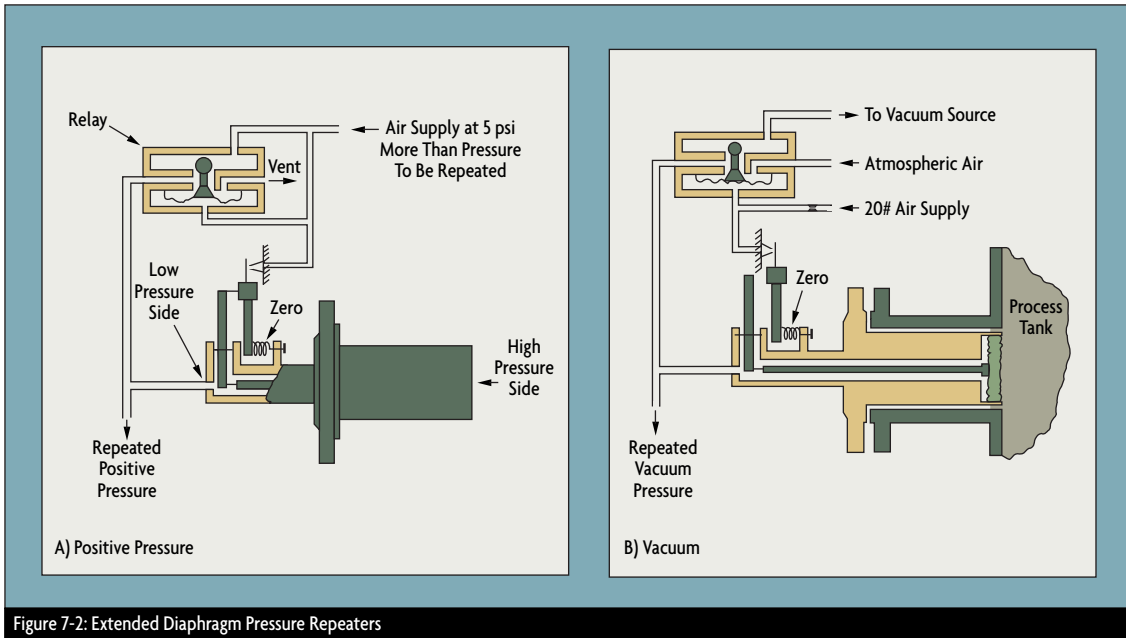

Figure 7-2: Extended Diaphragm Pressure Repeaters

Any changes in leg fill level (due to leakage or vaporization) introduce error into the level measurement. If the specific gravity of the filling fluid for the wet leg is greater than that of the process fluid, the high pressure side should be connected to the reference leg and the low to the tank.

If the condensate can be used to fill the reference leg, a condensate pot can be mounted and piped both to the high level connection of the tank and to the top of the vapor space. The condensate pot must be mounted slightly higher than the high level connection (tap) so that it will maintain a constant condensate level. Excess liquid will drain back into the tank. It is also desirable either to install a level gage on the condensate pot or to use a sight flow indicator in place of the pot, so that the level in the pot can conveniently be inspected.

Either method (wet or dry) assures a constant reference leg for the d/p cell, guaranteeing that the only variable will be the level in the

tank. The required piping and valving must always be provided on both the tank and the reference leg side of the d/p cell, so that draining and flushing operations can easily be performed. When a wet reference leg is used, a low thermal expansion filling fluid should be selected. Otherwise, the designer must correct for the density variations in the reference leg caused by ambient temperature variations.

If smart transmitters are used and if the filling fluid data is known, wet-leg temperature compensation can be provided locally. Alternatively, the host or supervisory control system can perform the compensation calculations.

If it is desired to keep the process vapors in the tank, a pressure repeater can be used. These devices repeat the vapor pressure (or vacuum) and send out an air signal identical to that of the vapor space. The measurement side of the repeater is connected to the vapor space and its output signal to the low pressure side of the d/p

cell. If the tank connection is subject to material build-up or plugging, extended diaphragm Type 1:1 repeaters can be considered for the service (Figure 7-2).

While repeaters eliminate the errors caused by wet legs, they do introduce their own errors as a function of the pressure repeated. For example, at 40 psig, repeater error is about 2 in. At 400 psig, it is 20 in. In many applications, the former is acceptable but the latter is not.

• d/p Cells

Because the designs of the various d/p cells are discussed in detail in another issue of *Transactions*, only a brief overview is provided here.

The motion balance cell is well suited for remote locations where instrument air or electric power are not available. If a bellows is used as the sensing element in a motion balance d/p cell, an increase in the pressure on either side causes the corresponding bellows to contract (Figure 7-3A). The bellows is connected to a

linkage assembly that converts the linear motion of the bellows into a rotary indicator motion, which can be

a draft range of 0-1/2 inH<sub>2</sub>O or as wide as 0-1,000 psid. Some electronic d/p cells can operate at line

can accumulate and affect the performance of the cell. Flat and extended diaphragm-type d/p cells,

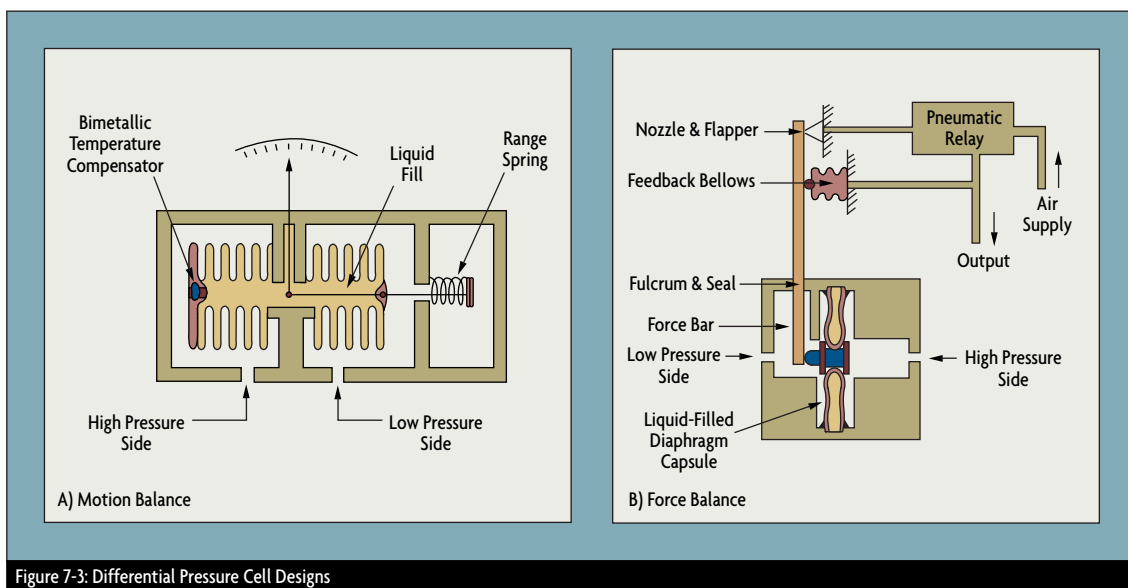

Figure 7-3: Differential Pressure Cell Designs

calibrated to indicate the tank level.

In a force-balance type of d/p cell, the sensing element (often a diaphragm) does not move. A force bar is provided to maintain the forces acting on the diaphragm in equilibrium (Figure 7-3B). In pneumatic d/p cells, this is often achieved by the use of a nozzle and flapper arrangement that guarantees that the pneumatic output signal will always be proportional to the differential pressure across the cell. The output of pneumatic d/p cells is linear and is usually ranged from 3 to 15 psig. The levels represented by such transmitted signals (pneumatic, electronic, fiberoptic or digital) can be displayed on local indicators or remote instruments. Pneumatic transmitters require a compressed air (or nitrogen) supply.

Electronic d/p cells provide ±0.5% of span or better precision typically conveyed via a 4-20 mA signal. The range of these simple and robust cells can be as narrow as

pressures up to 4,500 psig at 250°F. The drift and inaccuracy of some of these units have been tested for periods of up to 30 months, and the errors did not exceed the ±0.5% of span limit.

• **Difficult Process Fluids**

When the process fluid is a sludge, a viscous polymer or is otherwise hard to handle, the goal is to isolate the dirty process from the d/p cell. A flat diaphragm can be bolted to a block valve on the tank nozzle so that the d/p cell can be removed for cleaning or replacement without taking the tank out of service. If it is acceptable to take the tank out of service when d/p cell removal is needed, an extended diaphragm design can be considered. In this case, the diaphragm extension fills the tank nozzle so that the diaphragm is flush with the inside surface of the tank. This eliminates dead ends or pockets where solids

pressure repeaters, and chemical seals are available to protect d/p cells under these conditions.

Chemical seals, or diaphragm pressure seals, are available with fill liquids such as water, glycol, alcohol, and various oils. These seals are used when plugging or corrosion can occur on both sides of the cell. A broad range of corrosion-resistant diaphragm and lining materials is available. Teflon® lining is often used to minimize material build-up and coating. Level measurement accuracy does suffer when these seals are used. Capillary tube lengths should be as short as possible and the tubes should be shielded from the sun. In addition, either low thermal expansion filling fluids should be used or ambient temperature compensation should be provided, as discussed in connection with wet legs. If the seals leak, maintenance of these systems is usually done at the supplier's factory due to

the complex evacuation and back-filling procedures involved.

### Bubbler Tubes

Bubbler tubes provide a simple and inexpensive but less accurate ( $\pm 1-2\%$ ) level measurement system for corrosive or slurry-type applications. Bubblers use compressed air or an inert gas (usually nitrogen) introduced through a dip pipe (Figure 7-4A). Gas flow is regulated at a constant rate (usually at about 500 cc/min). A differential pressure regulator across a rotameter maintains constant flow, while the tank level determines the back-pressure. As the level drops, the

end of the dip pipe should be located far enough above the tank bottom so that sediment or sludge will not plug it. Also, its tip should be notched with a slot or "V" to ensure the formation of a uniform and continuous flow of small bubbles. An alternative to locating the dip pipe in the tank is to place it in an external chamber connected to the tank.

In pressurized tanks, two sets of dip pipes are needed to measure the level (Figure 7-4B). The two back-pressures on the two dip pipes can be connected to the two sides of a u-tube manometer, a differential pressure gage or a d/p

cell at least 10 psi greater than the expected maximum total pressure required (when the tank is full and the vapor pressure is at its maximum). An alternative to a continuous bubbler is to use a hand pump (similar to a bicycle tire pump) providing purge air only when the level is being read.

Bubblers do consume inert gases, which can later accumulate and blanket processing equipment. They also require maintenance to ensure that the purge supply is always available and that the system is properly adjusted and calibrated. When all factors are considered, d/p cells

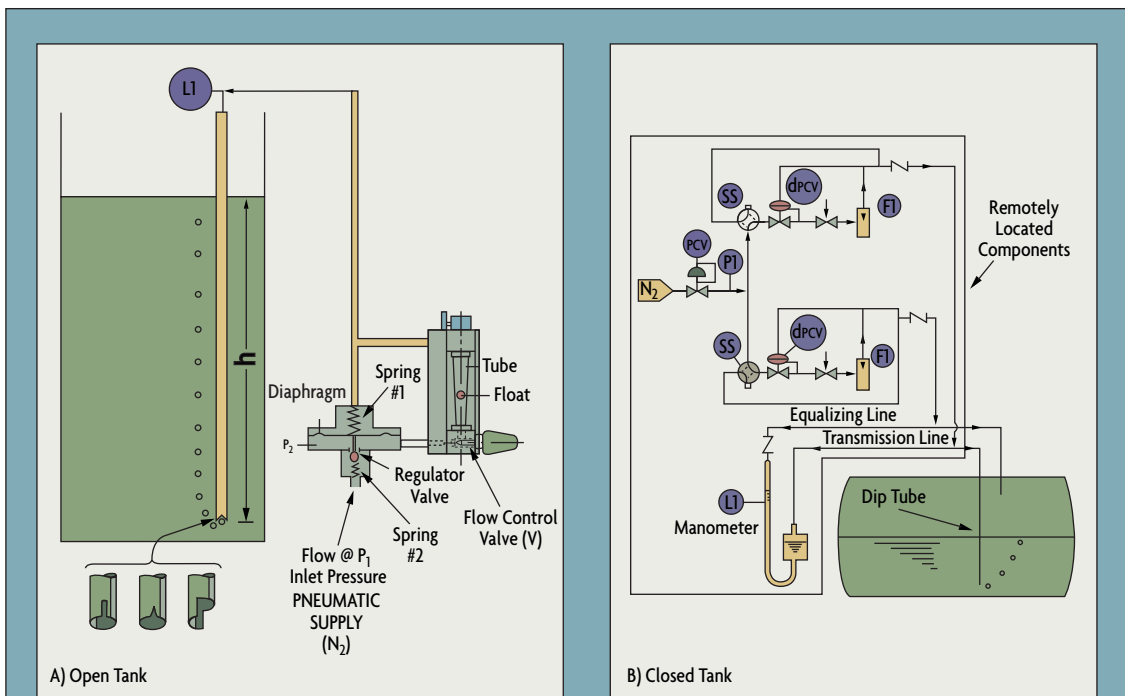

Figure 7-4: Bubbler Tube Measurement System

back-pressure is proportionally reduced and is read on a pressure gage calibrated in percent level or on a manometer or transmitter. The dip pipe should have a relatively large diameter (about 2 in.) so that the pressure drop is negligible. The bottom

cell/transmitter. The pneumatic piping or tubing in a bubbler system should be sloped toward the tank so that condensed process vapors will drain back into the tank if purge pressure is lost. The purge gas supply should be clean, dry, and available at

typically are preferred to bubblers in the majority of applications.

- Elevation & Suppression

If the d/p cell is not located at an elevation that corresponds to 0% level in the tank, it must be calibrated to

account for the difference in elevation. This calibration adjustment is called zero elevation when the cell is located above the lower tap, and is called zero suppression or zero

the high pressure side of the d/p cell should be connected to the tank if the specific gravity of the wet leg filling fluid is close to that of the light layer. It should be connected to the

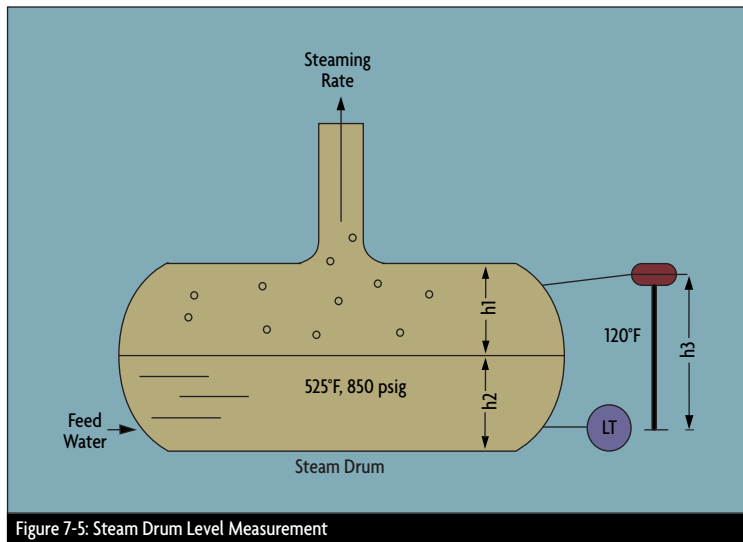

Figure 7-5: Steam Drum Level Measurement

depression when the cell is located below the lower tap. Most d/p cells are available with elevation and suppression ranges of 600% and 500% of calibrated span, respectively, as long as the calibrated span does not exceed 100% of the upper range limit of the cell.

For example, assume that an electronic d/p cell can be calibrated for spans between 0-10 psid (which is its lower range limit, LRL) and 0-100 psid (which is its upper range limit, URL). The cell is to be used on a 45-ft tall closed water tank, which requires a hydrostatic range of 0-20 psid. The cell is located about 11 feet (5 psid) above the lower tap of the tank; therefore, a zero elevation of 5 psid is needed. The d/p cell can handle this application, because the calibrated span is 20% of the URL and the elevation is 25% of the calibrated span.

On interface level measurement applications with a wet leg reference,

reference leg if the wet-leg fluid's SG is closer to that of the heavy layer.

• Special Applications

When the process fluid is boiling, such as in a steam drum, a wet reference leg is maintained by a condensate pot, which drains back into the steam drum so that the level of the wet leg is kept constant. Changes in ambient temperature (or sun exposure) will change the water density in the reference leg and, therefore, temperature compensation (manual or automatic) is needed.

Figure 7-5 describes a typical power plant steam drum level application. The differential pressure detected by the level d/p cell is:

$$d/p = h_1SG_1 + h_2SG_2 - h_3SG_3$$

$$d/p = 0.03h_1 + 0.76h_2 - 0.99h_3$$

Note that the SG of the saturated steam layer (0.03) and that of the

saturated liquid layer (0.76) vary not only with drum pressure but also with steaming rate. This causes the swelling of bubbles when the steaming rate rises (and SG<sub>2</sub> drops), as well as their collapse when the steaming rate drops (and SG<sub>2</sub> rises). Therefore, to make an accurate determination of both the level and the mass of the water in the steam drum, the calculation must consider not only the d/p cell output, but also the drum pressure and the prevailing steaming rate.

• Tank Farms

Computerized tank farm systems usually accept level signals from several tanks through field networks. These systems perform the level monitoring tasks using a variety of compensation and conversion algorithms. The algorithms provide density corrections, volumetric or mass conversions, and corrections to consider the shapes of horizontal, vertical or spherical tanks. These systems can perform safety functions, such as shutting off feed pumps to prevent overfilling.

Floats & Displacers

It was more than 2,200 years ago that Archimedes first discovered that the apparent weight of a floating object is reduced by the weight of the liquid displaced. Some 2,000 years later, in the late 1700s, the first industrial application of the level float appeared, when James Brindley and Sutton Thomas Wood in England and I. I. Polzunov in Russia introduced the first float-type level regulators in boilers.

Floats are motion balance devices that move up and down with liquid level. Displacers are force balance devices (restrained floats), whose apparent weight varies in accordance with Archimedes' principle:

the buoyant force acting on an object equals the weight of the fluid displaced. As the level changes around

to 80°C (-40 to 180° F) and up to 150 psig for rubber or plastic floats, and -40 to 260°C (-40 to 500°F) and up to

(SG) of the process fluid. For clean liquids a 0.1 SG difference might suffice, while for viscous or dirty applications,

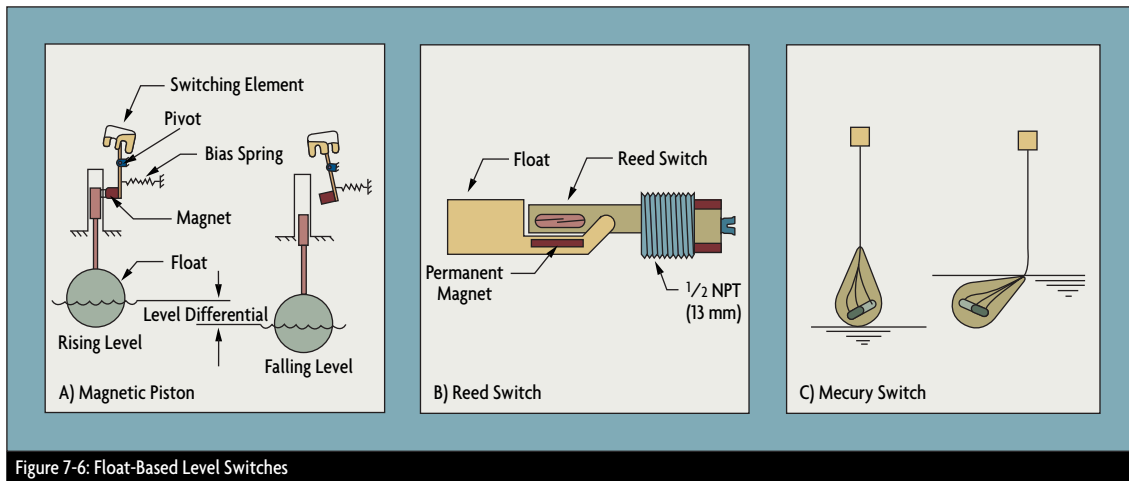

Figure 7-6: Float-Based Level Switches

the stationary (and constant diameter) displacer float, the buoyant force varies in proportion and can be detected as an indication of level. Regular and displacer floats are available as both continuous level transmitters and point-sensing level switches.

In industrial applications, displacer floats are often favored because they do not require motion. Furthermore, force can often be detected more accurately than position. However, regular floats are also used, mostly for utilities and in other secondary applications.

• **Float Level Switches**

The buoyant force available to operate a float level switch (that is, its net buoyancy) is the difference between the weight of the displaced fluid (gross buoyancy) and the weight of the float. Floats are available in spherical (Figure 7-6A), cylindrical (Figure 7-6B), and a variety of other shapes (Figure 7-6C). They can be made out of stainless steel, Teflon®, Hastelloy, Monel, and various plastic materials. Typical temperature and pressure ratings are -40

750 psig for stainless steel floats. Standard float sizes are available from 1 to 5 inches in diameter. Custom float sizes, shapes, and materials can be ordered from most manufacturers. The float of a side-mounted switch is horizontal; a permanent magnet actuates the reed switch in it (Figure 7-6B).

Floats should always be lighter than the minimum expected specific gravity

a difference of at least 0.3 SG is recommended. This provides additional force to overcome the resistance due to friction and material build-up. In dirty applications, floats should also be accessible for cleaning.

Floats can be attached to mechanical arms or levers and can actuate electrical, pneumatic, or mechanical mechanisms. The switch itself can be

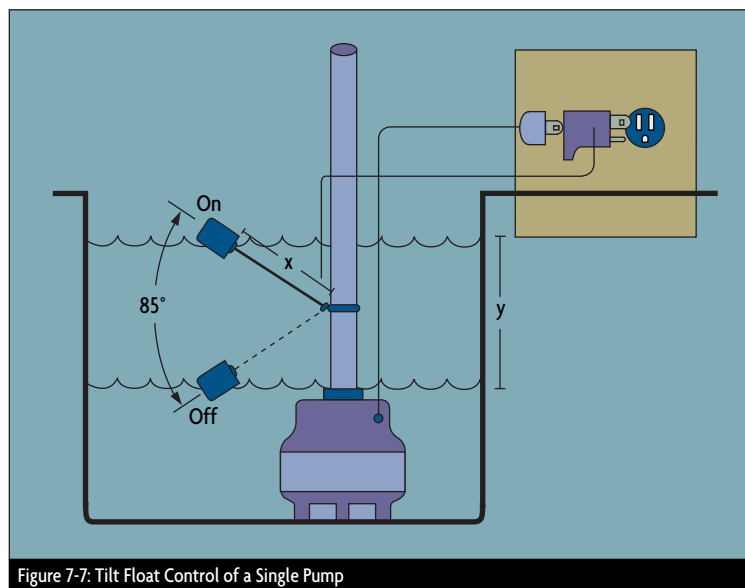

Figure 7-7: Tilt Float Control of a Single Pump

mercury (Figures 7-6A and 7-6C), dry contact (snap-action or reed type, shown in Figure 7-6B), hermetically sealed, or pneumatic. The switch can

duplex sump-pump stations. A simplex (one pump) system will use a single switch wired in series with the motor leads so that the switch

and/or visual alarm.

Figure 7-8A illustrates how a side-mounted float switch might actuate an adjacent, sealed reed switch. The main advantage of this design is that the lever extension tends to amplify the buoyant force generated by the float. Therefore the float itself can be rather small. The main disadvantage is that the tank must be opened in order to perform maintenance on the switch. If the buoyant force of the float is used mechanically to actuate a snap-action switch, a force of only one ounce is needed.

In top (or bottom) mounted magnetic float switches (Figure 7-8B), the magnet is in the cylindrical float that travels up or down on a short vertical guide tube containing a reed switch. The float's motion is restrained by clips and can be only 1/2 in or less. These float and guide tubes are available with multiple floats that can detect several levels. The switch assembly itself can be either inserted directly into the tank or side-mounted in a separate chamber.

A magnetic piston operated switch also can be mounted in an external chamber (Figure 7-8C). As the magnet slides up and down

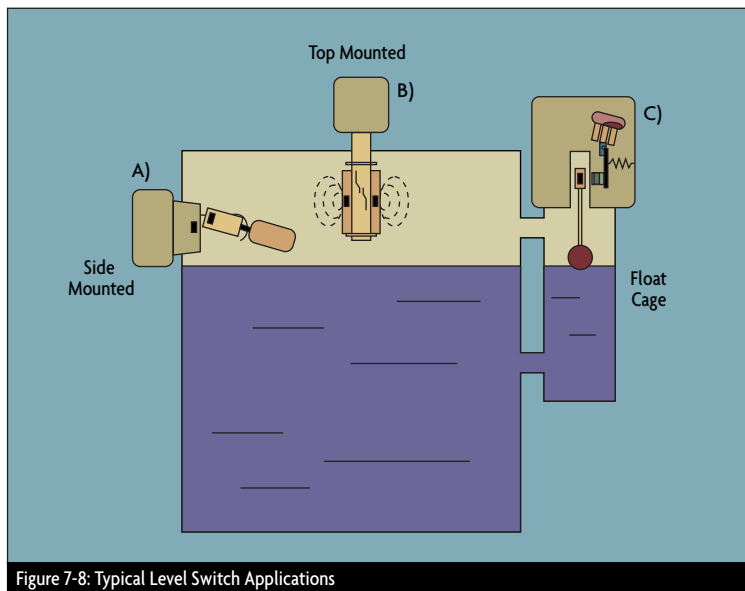

Figure 7-8: Typical Level Switch Applications

be used to actuate a visual display, annunciator, pump, or valve. The electric contacts can be rated light-duty (10-100 volt amps, VA) or heavy-duty (up to 15 A @ 120 Vac). If the switch is to operate a circuit with a greater load than the rating of the switch contacts, an interposing relay needs to be inserted. If the switch is to be inserted in a 4-20 mA dc circuit, gold-plated dry contacts should be specified to ensure the required very low contact resistance.

• Applications & Installations

In the tilt switch (Figure 7-6C), a mercury element or relay is mounted inside a plastic float; the float's electrical cable is strapped to a pipe inside the tank or sump. As the level rises and falls, the float tilts up and down, thus opening and closing its electric contact. The free length of the cable determines the actuation level. One, two, or three switches can be used to operate simplex and

directly starts and stops the pump motor (Figure 7-7).

A duplex (two pump) application might use three switches: one at the tank bottom (LO) to stop both pumps, another in the middle (HI) to start one pump, and the last at the top (HI-HI) to actuate the second pump, as well as perhaps an audible

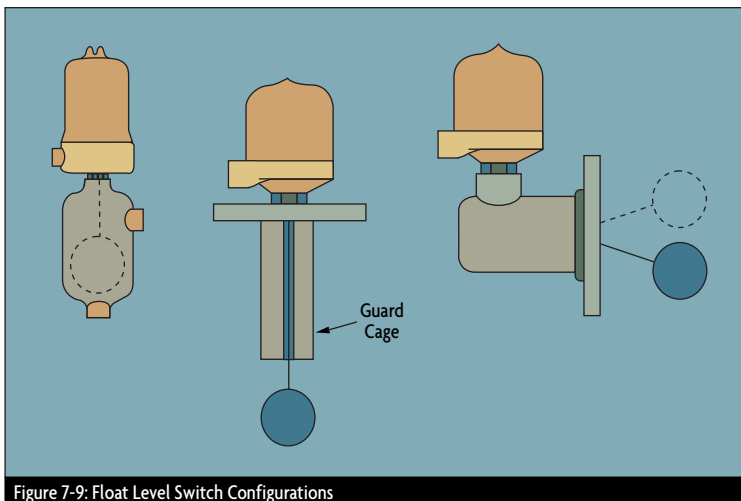

Figure 7-9: Float Level Switch Configurations

inside a non-magnetic tube, it operates the mercury switch outside the tube. These switches are completely sealed and well suited for heavy duty industrial applications up to 900 psig and 400°C (750°F), meeting ASME code requirements. These

• **Displacer Switches**

Whereas a float usually follows the liquid level, a displacer remains partially or completely submerged. As shown in Figure 7-10A, the apparent weight of the displacer is reduced as it becomes covered by more liquid.

while a displacer switch can be tested simply by lifting a suspension (Figure 7-10A). Displacer switches are available with heavy-duty cages and flanges for applications up to 5000 psig at 150°C (300°F), suitable for use on hydraulic accumulators, natural

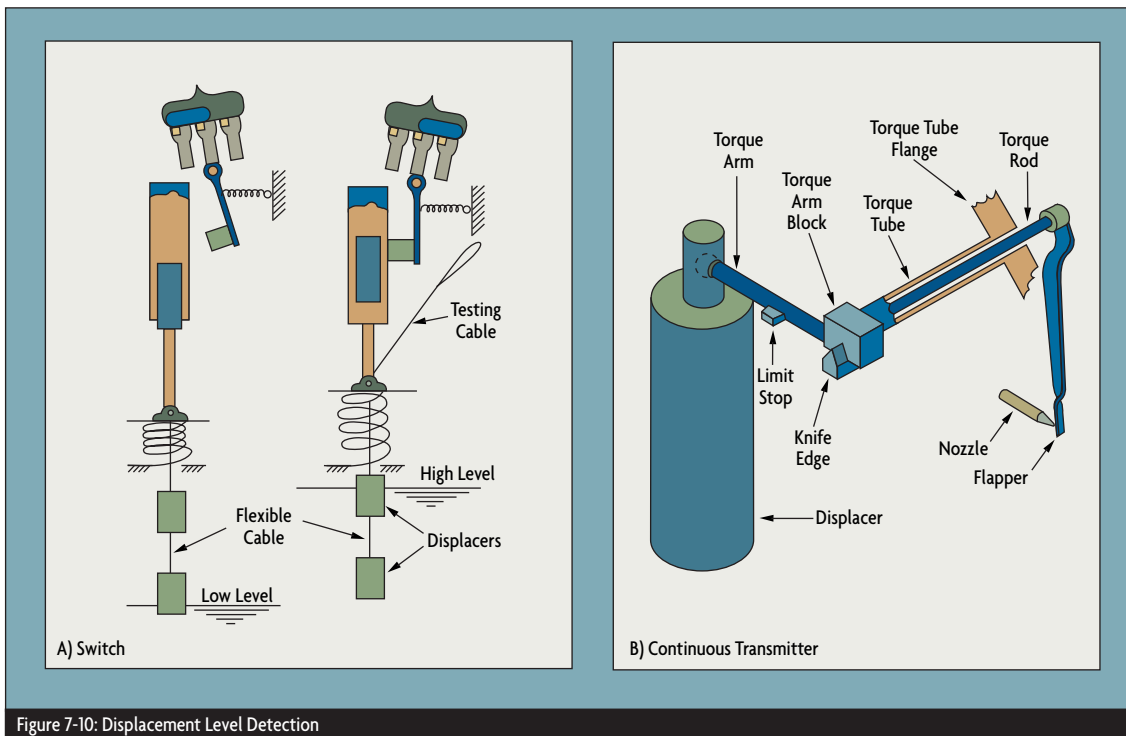

Figure 7-10: Displacement Level Detection

switches can be side, top, or cage mounted (Figure 7-9) and can serve both alarm and control functions on steam drums, feedwater heaters, condensate pots, gas/oil separators, receivers, and accumulators. Light-duty caged float switches are also available for service ratings up to 250 psig at 200°C (400°F) and 400 psig at 40°C (100°F)—suitable for many boilers, condensate receivers, flash tanks, day tanks, holding tanks, and dump valve controls. The cages can be provided with level gages. Multiple switches are available for multiple-switching applications such as boiler level alarms and controls.

When the weight drops below the spring tension, the switch is actuated. Displacer switches are more reliable than regular floats on turbulent, surging, frothy, or foamy applications. Changing their settings is easy because displacers can be moved anywhere along the suspension cable (up to 50 ft). These switches are interchangeable between tanks because differences in process density can be accommodated by changing the tension of the support spring.

Testing the proper functioning of a regular float switch may require filling the tank to the actuation level,

gas receivers, high pressure scrubbers, and hydrocarbon flash tanks.

• **Continuous Level Displacers**

Displacers are popular as level transmitters and as local level controllers, particularly in the oil and petrochemical industries. However, they are not suited for slurry or sludge service because coating of the displacer changes its volume and therefore its buoyant force. They are most accurate and reliable for services involving clean liquids of constant density. They should be temperature-compensated, particularly if variations in process temperature cause



significant changes in the density of the process fluid.

When used as a level transmitter, the displacer, which is always heavier than the process fluid, is suspended from the torque arm. Its apparent

force is balanced by a spring, there is some movement, while with a force-balance detector, the displacer stays in one position and only the level over the displacer varies.

Displacer units are available with

standpipes with level gages and isolating valves (Figure 7-11). This way it is possible to recalibrate or maintain the displacer without interrupting the process.

• Interface Applications

When measuring the interface between a heavy liquid and a light liquid (such as oil on water), the top connection of the displacer is placed into the light and the bottom connection into the heavy liquid layer. If the output of such a transmitter is set to zero when the chamber is full of the light liquid, and to 100% when it is full with the heavy phase, the output will correspond to the interface level. Naturally, when interface is being measured, it is essential that the two connections of the displacer chamber be located in the two different liquid layers and that the chamber always be flooded. Displacer diameter can be changed to match the difference in liquid densities, and displacer length can be set to match the vertical range of the level interface variation.

Regular floats can also be used for interface detection if the difference in SG between the two process liquids is more than 0.05. In such applications, a float density is needed that is greater than the lighter liquid and less than the heavier liquid. When so selected, the float will follow the interface level and, in clean services, provide acceptable performance.

• Continuous Level Floats

Of the various float sensor designs used for continuous level measurement, the oldest and arguably most accurate is the tape level gage (Figure 7-12A). In this design, a tape or cable

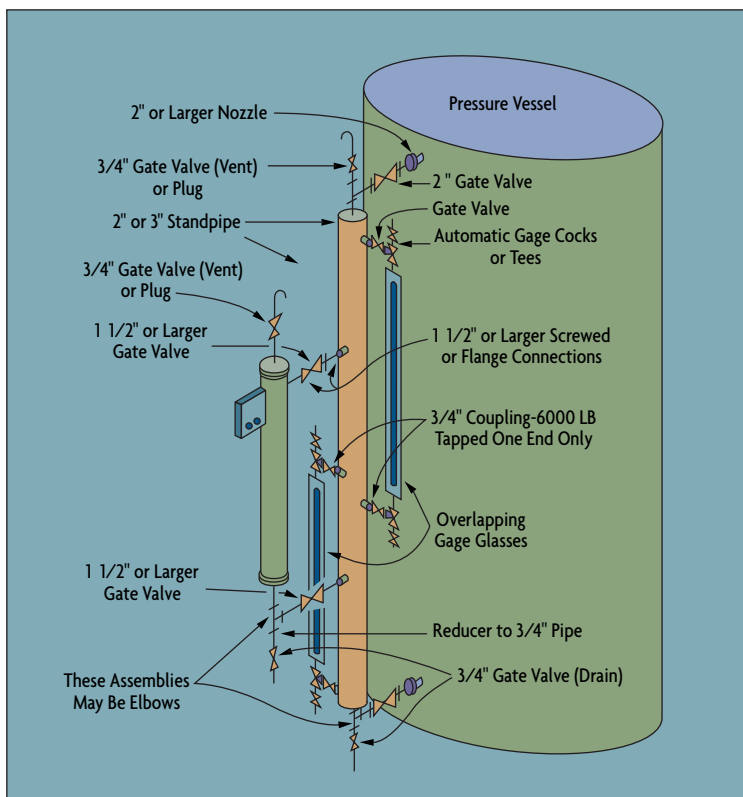

Figure 7-11: Installation to API Standards

weight causes an angular displacement of the torque tube (a torsion spring, a frictionless pressure seal). This angular displacement is linearly proportional to the displacer's weight (Figure 7-10B).

Standard displacer volume is 100 cubic inches and the most commonly used lengths are 14, 32, 48, and 60 in. (Lengths up to 60 ft are available in special designs.) In addition to torque tubes, the buoyant force can also be detected by other force sensors, including springs and force-balance instruments. When the buoyant

both pneumatic and electronic outputs and can also be configured as local, self-contained controllers. When used in water service, a 100 cubic inch displacer will generate a buoyant force of 3.6 pounds. Therefore, standard torque tubes are calibrated for a force range of 0-3.6 lb<sub>f</sub> and thin-walled torque tubes for a 0-1.8 lb<sub>f</sub> range.

For oil refineries and other processes that are operated continuously, the American Petroleum Institute recommends (in API RP 550) that displacers be installed in external

connects the float inside the tank to a gage board or an indicating take-up reel mounted on the outside of the tank. The float is guided up and down the tank by guide wires or travels inside a stilling well. These level indicators are used in remote, unattended, stand-alone applications, or they can be provided with data transmission electronics for integration into plant-wide control systems.

To install the tape gage, an opening is needed at the top of the tank and an anchor is required at its bottom. When properly maintained, tape gages are accurate to  $\pm 1/4$  in. It is important to maintain the guide wires under tension, clean and free of corrosion, and to make sure that the tape never touches the protective piping in which it travels. If this is not done, the float can get stuck on the guide wires or the tape can get stuck to the pipe. (This can happen if the level does not change for long periods or if the tank farm is

with a visual indicator, consisting of  $1/4$ -in triangular wafer elements. These elements flip over (from green to red, or any other color) when the magnet in the float reaches their level (Figure 7-12B). Alarm switches and transmitter options are available with similar magnetic coupling schemes (Figure 7-12C). In a similar design, a series of reed switches is located inside a stand-pipe. The change in output voltage as the individual reed switches are closed by the rising magnet is measured, giving an indication of level.

The operation of magnetostrictive sensors is based on the Villari effect. In the magnetic waveguide-type continuous level detector, the float (or floats, when detecting interface) travels concentrically up and down outside a vertical pipe. Inside the pipe is a concentric waveguide made of a magnetostrictive material. A low current interrogation pulse is sent down the waveguide, creating an electro-

This tank level sensing method is highly accurate, to  $\pm 0.02$  in, and therefore is ideal for precision inventory management operations. The sensor is available in lengths of 2-25 ft and can be inserted into the tank from the top of the vessel through flanged, screwed, or welded connections. For the simultaneous measurement of both interface and total level, a two-float system is available (Figure 7-12D). A resistance temperature detector (RTD) is also available for temperature compensation. Like all other float level instruments, this design too is for clean liquids. Rating is up to 150°C (300° F) and 300 psig. The transmitter output can be 4-20 mA dc analog or fieldbus-compatible digital.

• **Float Control Valves**

Float-operated control valves combine level measurement and level control functions into a single level regulator. While simple and inexpensive, they are limited to applications

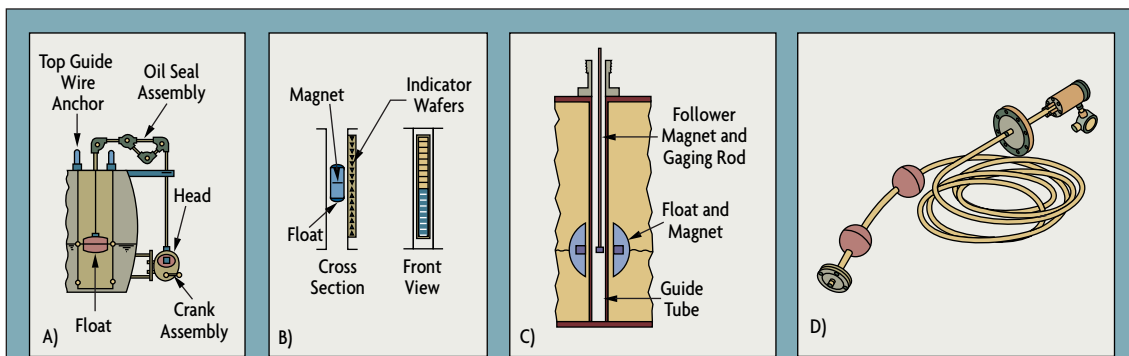

Figure 7-12: Continuous Float Level Detectors

located in a humid region.)

Another continuous level indicator is the magnetic level gage, consisting of a magnetic float that travels up and down on the inside of a long, non-magnetic (usually stainless steel) pipe. The pipe is connected to flanged nozzles on the side of the tank. The pipe column is provided

magnetic field along the length of the waveguide. When this field interacts with the permanent magnet inside the float, a torsional strain pulse (or waveguide twist) is created and detected as a return pulse. The difference in the interrogation time and the return pulse time is proportional to the liquid level in the tank.

involving small flows and small pressure drops across the valve. This is because the force available to throttle the valve is limited to that provided by the buoyant force acting on the float, multiplied by the lever action of the float arm. This does not suffice to close large valves against high pressure differentials.



Yet, for simple and unattended applications (like controlling the make-up water supply into a cooling tower basin or draining condensate from a trap), they are acceptable. It is important to understand that float regulators are simple proportional controllers: they are incapable of holding level at a single setpoint. What they can do is open or close a valve as the float travels through its control range. Therefore, instead of a setpoint, regulators have a throttling range. If the range is narrow (floats usually fully stroke their valve over a few inches of float travel), it gives the impression of a constant level.

In fact, level will vary over the throttling range because the only way for the regulator to increase the feed flow (say into a cooling tower

basin) is to first let the level drop so that the sinking of the float will further open the valve. The relationship between the maximum flow through a linear valve ( $Q_{\max}$ ) and the range in liquid level ( $h$ ) is called the proportional sensitivity of the regulator

( $K_c = Q_{\max}/h$ ), expressed in units of GPM/inch. The offset of a float regulator is the distance (in inches) between the center of the float range and the amount of elevation of the float required to deliver the flowrate demanded by the process. ⓘ

### References & Further Reading

- *OMEGA Complete Flow and Level Measurement Handbook and Encyclopedia*<sup>®</sup>, OMEGA Press, 1995.
- *OMEGA Volume 29 Handbook & Encyclopedia, Purchasing Agents Edition*, OMEGA Press, 1995.
- *Instrument Engineer's Handbook*, Bela G. Liptak, editor, CRC Press, 1995.
- *Instrumentation for Process Measurement and Control*, Third Edition, N. A. Anderson, Chilton, 1980.
- *Measurement and Control of Liquid Level*, C. H. Cho, Instrument Society of America, 1982.
- *Principles of Industrial Measurement for Control Applications*, E. Smith, Instrument Society of America, 1984.

# RF/Capacitance Level Instrumentation

Capacitance level detectors are also referred to as radio frequency (RF) or admittance level sensors. They operate in the low MHz radio frequency range, measuring admittance of an alternating current (ac) circuit that varies with level. Admittance is a measure

of the conductivity in an ac circuit, and is the reciprocal of impedance. Admittance and impedance in an ac circuit are similar to conductance and resistance in a direct current (dc) circuit. In this chapter, the term capacitance level sensor will be used instead of RF or admittance.

charge. The storage capability of a capacitor is measured in farads. As shown in Figure 8-1, the capacitor plates have an area (A) and are separated by a gap (D) filled with a non-conducting material (dielectric) of dielectric constant (K). The dielectric constant of a vacuum is 1.0; the

$$C = KA/D$$

material (that is, the less conductive it is). Capacitance (C) is calculated as:

If the area (A) of and the distance (D) between the plates of a capacitor remain constant, capacitance will vary only as a function of the dielectric constant of the substance filling the gap between the plates. If a change in level causes a change in the total dielectric of the capacitance system, because (as illustrated in Figure 8-1B) the lower part of area (A) is exposed to a liquid (dielectric  $K_l$ ) while the upper part is in contact with a vapor (dielectric  $K_v$ , which is close to 1.0), the capacitance measurement will be proportional to level.

In the case of a horizontally mounted level switch (Figure 8-2), a conductive probe forms one of the plates of the capacitor ( $A_1$ ), and the vessel wall (assuming it is made from a conductive material) forms the other ( $A_2$ ). An insulator with a low dielectric constant is used to isolate the conductive probe from the housing, which is connected to the vessel

INDUSTRY	MATERIALS SENSED
Chemical/Petrochemical	Soda Ash, Fuel, Oil, Clay, Liquids & Powders
Feed & Grain	Pellets, Granules, Flakes, Fats, Molasses, Calcium Dust
Food	Sugar, Salt, Flour, Powdered Milk, Various Liquids
Pet Food	Pellets, Rawhides, Grains
Plastics/Rubber	Plastic Pellets, Resin, Regrind, Powders, Rubber
Foundries	Silica Sand, Foundry Sand
Beer/Breweries	Malt, Barley Liquids
Pharmaceuticals	Various Powders & Liquids
Power/Utilities	Coal, Wood, Sawdust, Petro-Coke
Water/Waste Treatment	Limestone, Hydrated Lime, Water
Charcoal	Charred Sawdust, Wood
Saw Mills/Woodworking	Wood Shavings, Sawdust
Mining & Miscellaneous	Various Minerals, Clay, Metals, Stone, Glass, Bentonite

of the conductivity in an ac circuit, and is the reciprocal of impedance. Admittance and impedance in an ac circuit are similar to conductance and resistance in a direct current (dc) circuit. In this chapter, the term capacitance level sensor will be used instead of RF or admittance.

Table 6 lists some of the industries and applications where capacitance-type level sensors are used.

## Theory of Operation

A capacitor consists of two conductors (plates) that are electrically isolated from one another by a non-conductor (dielectric). When the two conductors are at different potentials (voltages), the system is capable of storing an electric

charge. The storage capability of a capacitor is measured in farads. As shown in Figure 8-1, the capacitor plates have an area (A) and are separated by a gap (D) filled with a non-conducting material (dielectric) of dielectric constant (K). The dielectric constant of a vacuum is 1.0; the

dielectric constants of a variety of materials are listed in Table 7. The dielectric constant of a substance is proportional to its admittance. The lower the dielectric constant, the lower the admittance of the

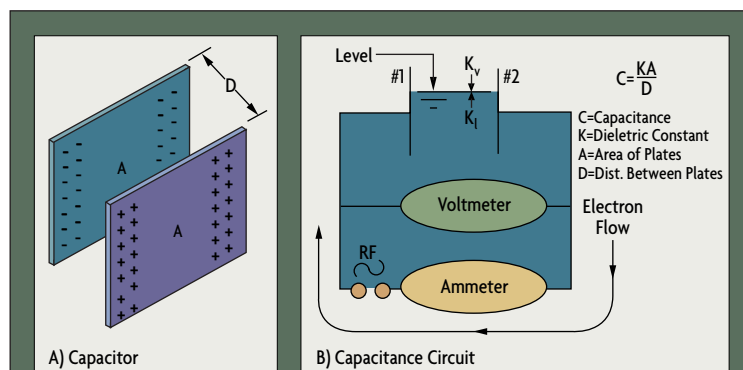

Figure 8-1: Capacitance Theory of Operation

wall. The probe is connected to the level sensor via the conductive threads of the housing. Measurement is made

longer surrounded by vapors ( $K_1$ ), but by the process material ( $K_2$ ), the resulting capacitance change is directly

detectable change in capacitance resulting from a change in dielectric constant ( $K_2 - K_1$ ).

In most level-sensing applications, the reference material is air ( $K_1 = 1.0$ ). Table 7 gives the  $K_2$  values of a variety of process materials. As the dielectric constant of the process material gets close to that of air ( $K_2$  for plastic pellets, for example, is 1.1), the measurement becomes more difficult.

### Probe Designs

The most common probe design is a stainless steel rod of 1/4 in. or 1/2 in. diameter, suitable for most non-conductive and non-corrosive materials. The probe is insulated from the housing and bin wall by a low-dielectric insulator, such as Nylon or Ryton. These polymers have maximum operating temperatures of 175-230°C (350-450°F). Ceramics can be used for higher temperature applications or if abrasion resistance is required. For applications where the process material is conductive and corrosive, the probe must be coated with Teflon® or Kynar.

Some point level sensors are available with build-up immunity, or coating rejection functionality. This is

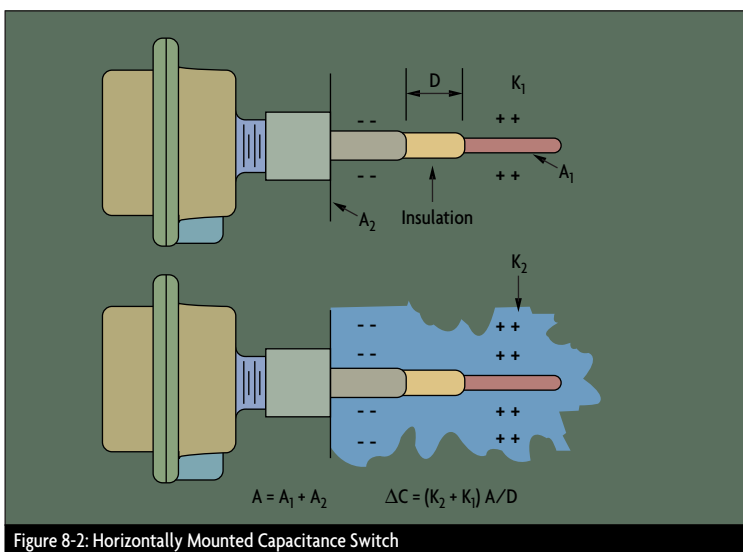

Figure 8-2: Horizontally Mounted Capacitance Switch

by applying an RF signal between the conductive probe and the vessel wall.

The RF signal results in a minute current flow through the dielectric process material in the tank from the probe to the vessel wall. When the level in the tank drops and the probe is exposed to the even less conductive vapors, the dielectric constant drops. This causes a drop in the capacitance reading and a minute drop in current flow. This change is detected by the level switch's internal circuitry and translated into a change in the relay state of the level switch. In the case of continuous level detectors (vertical probes), the output is not a relay state, but a scaled analog signal.

The total area is the combined area of the level sensor probe and the area of the conductive vessel wall ( $A = A_1 + A_2$ ), and the distance ( $D$ ) is the shortest distance between the sensor probe and the vessel wall. Both of these values are fixed. Therefore, when the probe is no

related to the difference in dielectric constant between the two media:

$$\text{Change in } C = (K_2 - K_1)(A/D)$$

The sensitivity of a capacitance sensor is expressed in pico-farads (pF). The capacitance unit is the farad, defined as the potential created when a one-volt battery connected to a capacitor causes the storage of one

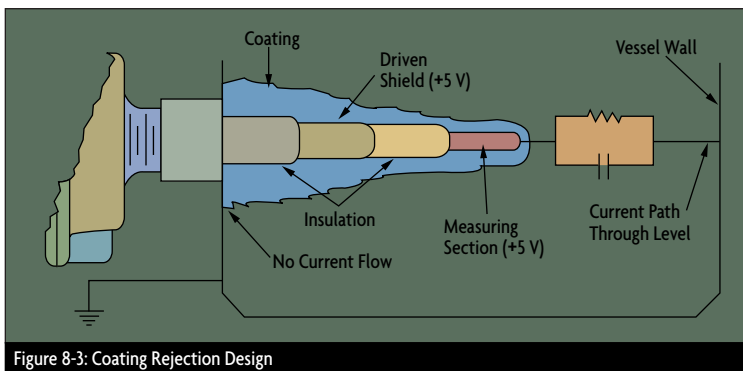

Figure 8-3: Coating Rejection Design

coulomb of electric energy. A pico-farad is one trillionth of that, and the sensitivity of an accurate capacitance detector is 0.5 pF. This is the minimum

required when the process material is wet or sticky and likely to cause permanent coating. Build-up immunity is provided by the addition of a

second active section of probe and a second insulator (Figure 8-3). This second active section (the driven shield) is driven at the same potential and frequency as the measuring probe. Because current cannot flow between equal potentials, the measuring probe

used to suspend the probe up to 15 m (50 ft) (Figure 8-4B). Most capacitance level sensors are provided with 3/4 to 1-1/2 in NPT mounting connectors. The matching female coupling is usually welded to the vessel wall and the capacitance probe is screwed into the

• **Electronics & Housings**

The electronic circuitry of the probe performs the functions of: 1) rectifying and filtering the incoming power, 2) generating the radio frequency signal, 3) measuring the changes in current flow, and 4) driving and controlling interface devices such as relays, analog signal generators and display meters. The circuitry is usually of solid state design and provided with potentiometer adjustments for setting sensitivity and time delays.

Because the level sensor will ultimately drive an external device, it is advisable to evaluate for system compatibility the number of relays required, their capacities, or the analog signals required, time delays, and power supply requirements. More advanced microprocessor-based units are self-calibrating; sensitivity and time delay adjustments are under pushbutton control. These units are often supplied with self-test capability and built-in temperature compensation.



Capacitance probes typically are coated with Teflon® (shown), Kynar, or polyethylene

does not sense material build-up between the probe and vessel wall.

Typical insertion lengths of standard capacitance probes range from 7 to 16 in. These probes typically are side-mounted (Figure 8-4A). Vertical probes can be extended by solid rods up to a length of 1.2 to 1.5 m (4 to 5 ft), or a steel cable with a weight can be

used to suspend the probe up to 15 m (50 ft) (Figure 8-4B). Most capacitance sensors also are available (Figure 8-4C) and are flange-mounted.

In applications where the vessel is non-conductive and unable to form the return path for the RF signal, a second probe placed parallel to the active one or a conductive strip can be installed.

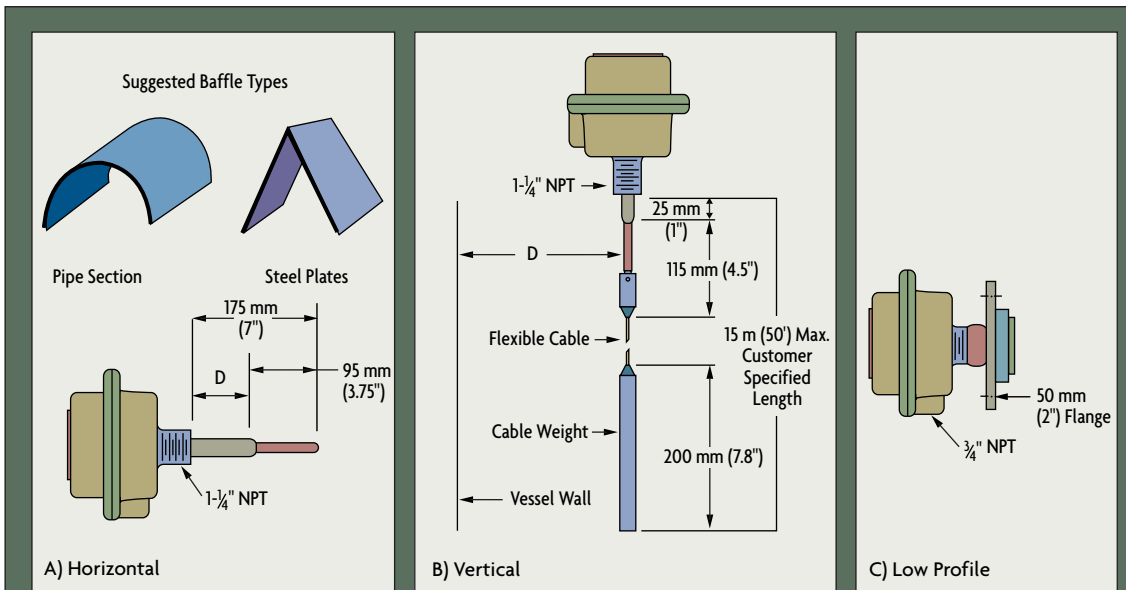

Figure 8-4: Design and Installation of Capacitance Level Sensors

The more advanced designs are also two-wire, intrinsically safe, and supply your choice of standard 4-20 mA or digitally enhanced output using the HART (Highway

with time delays for filtering out false readings caused by material shifts or splashing liquids. In addition, the feature of failsafe selectability provides a predetermined state for

### • The Dielectric Constant

The dielectric constant of the process material is the most important aspect of the process data. The higher the difference between the dielectric constants (of the process material and the vapor space or between the two layers in the case of an interface measurement), the easier the measurement. If the difference is low ( $K_2 - K_1 < 1.0$  in Figure 8-2), a high sensitivity design (0.5 pF) must be used.

Each sensor has a capacitance threshold, defined as the amount of capacitance change required to cause a change in the sensor output. The dielectric constant of a material can change due to variations in temperature, moisture, humidity, material bulk density, and particle size. If the change in dielectric constant results in a greater capacitance change than the calibrated capacitance threshold of the sensor, a false reading will result. This condition can usually be corrected by reducing the sensitivity (increasing the capacitance threshold) of the sensor.

As shown in connection with Figure 8-3, sensitivity can be increased by increasing the probe length (A) or by decreasing the size of the gap (D). Either or both changes will minimize the effect of dielectric constant fluctuations or increase sensitivity to low dielectrics. It is usually more practical to specify a longer probe than to decrease the distance (D) from the vessel wall. When the probe is installed from the side (Figure 8-4A), D is fixed, whereas if the probe is inserted from the top of the tank, D can be changed (if other considerations permit) by moving the probe closer to the wall of the vessel.

If the same vessel will hold different materials at different times, the capacitance sensor must be

Table 7: Dielectric Constants

SOLIDS					
DIELECTRIC CONSTANT			DIELECTRIC CONSTANT		
Acetic Acid	4.1		Phenol	4.3	
Asbestos	4.8		Polyethylene	4.5	
Asphalt	2.7		Polypropylene	1.5	
Bakelite	5.0		Porcelain	5.7	
Calcium Carbonate	9.1		Quartz	4.3	
Cellulose	3.9		Rubber (Hard)	3.0	
Ferrous Oxide	14.2		Sand	3.5	
Glass	3.7		Sulphur	3.4	
Lead Oxide	25.9		Sugar	3.0	
Magnesium Oxide	9.7		Urea	3.5	
Naphthalene	2.5		Zinc Sulfide	8.2	
Nylon	45.0		Teflon®	2.0	
Paper	2.0				
LIQUIDS					
	TEMP °F/°C	DIELECTRIC CONSTANT		TEMP °F/°C	DIELECTRIC CONSTANT
Acetone	71/22	21.4	Heptane	68/20	1.9
Ammonia	-27/-33	22.4	Hexane	68/20	1.9
Aniline	32/0	7.8	Hydrogen Chloride	87/28	4.6
Benzene	68/20	2.3	Iodine	224/107	118.0
Benzil	202/94	13.0	Kerosene	70/21	1.8
Bromine	68/20	3.1	Methanol	77/25	33.6
Butane	30/-1	1.4	Methyl Alcohol	68/20	33.1
Carbon Tetrachloride	68/20	2.2	Methyl Ether	78/26	5.0
Castor Oil	60/16	4.7	Mineral Oil	80/27	2.1
Chlorine	32/0	2.0	Naphthalene	68/20	2.5
Chloroform	32/0	5.5	Octane	68/20	2.0
Cumene	68/20	2.4	Pentane	68/20	1.8
Cyclohexane	68/20	2.0	Phenol	118/47	9.9
Dimethylheptane	68/20	1.9	Phosgene	32/0	4.7
Dimethylpentane	68/20	1.9	Propane	32/0	1.6
Dowtherm	70/21	3.3	Pyridine	68/20	12.5
Ethanol	77/25	24.3	Styrene	77/25	2.4
Ethyl Acetate	68/20	6.4	Sulphur	752/400	3.4
Ethyl Benzene	68/20	2.5	Toluene	68/20	2.4
Ethyl Benzene	76/24	3.0	Urethane	74/23	3.2
Ethyl Ether	68/20	4.3	Vinyl Ether	68/20	3.9
Ethylene Chloride	68/20	10.5	Water	32/0	88.0
Formic Acid	60/16	58.5	Water	68/20	80.0
Freon 12	70/21	2.4	Water	212/100	48.0
Glycol	68/20	41.2	Xylene	68/20	2.4

Addressable Remote Transducer) protocol. Accuracy (including linearity, hysteresis, and repeatability, but excluding temperature and supply voltage effects) is typically 0.25% of range. Minimum span is 4 pF, and the upper range limit (URL) is 2,500 pF.

Level switches are usually provided

the relay output in the event of a power failure or malfunction.

Sensor housings are typically made from cast aluminum, steel, or synthetic materials such as glass-reinforced nylon. Most housings are suitable for outdoor installations in dusty or wet environments.



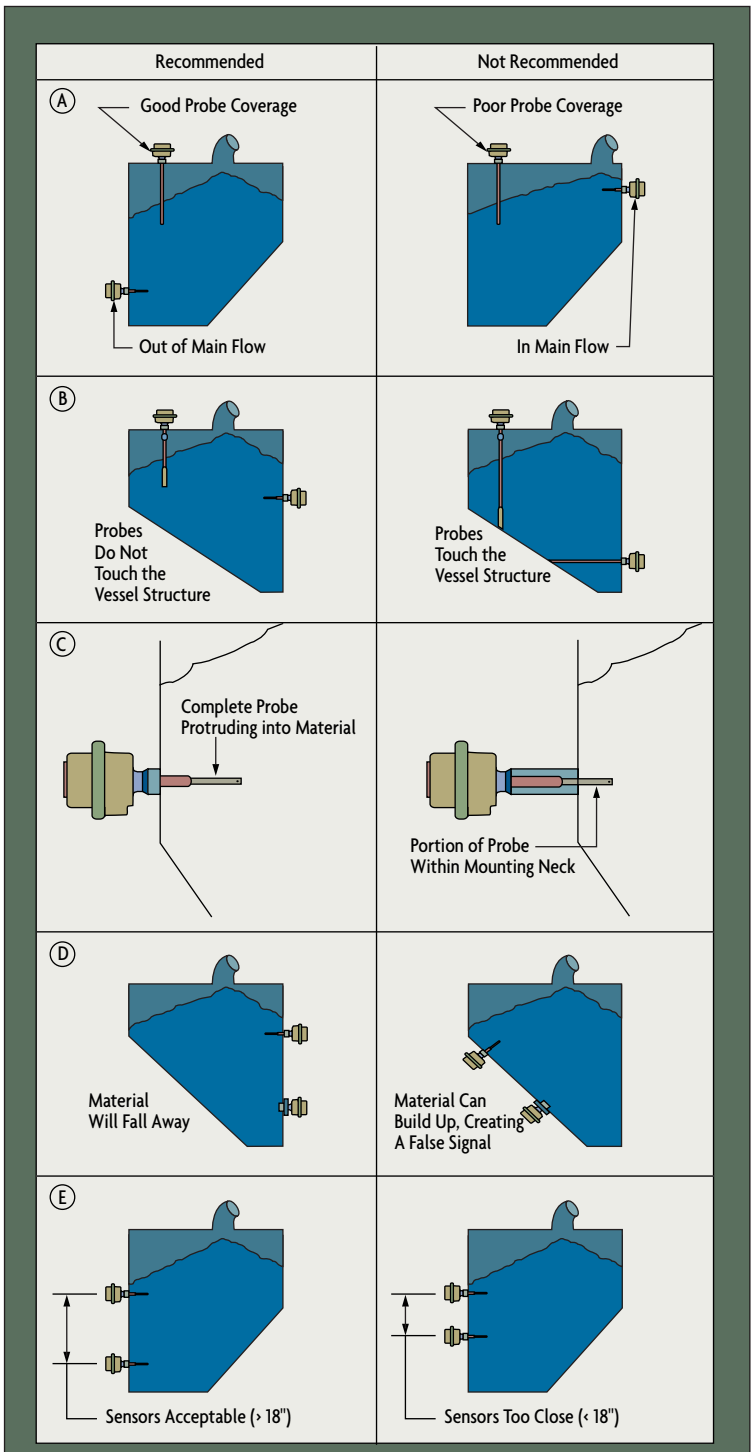

Figure 8-5: Capacitance Probe Installation Recommendations

equipped with local or remote recalibration capability.

Light density materials under 20 lb/ft<sup>3</sup> and materials with particle sizes exceeding 1/2 in. in diameter can be a problem due to their very low dielectric constants (caused by the large amount of air space between particles). These applications might not be suited for capacitance-type level measurement.

• Application Considerations

Materials that are conductive (water-based liquids with a conductivity of 100 micromhos/cm or more) can cause a short circuit between a bare stainless steel probe and the vessel wall. As the liquid level drops, the probe remains wetted, providing a conductive path between the probe and the vessel wall. The faster the level changes, the more likely this false indication is to occur. It is advisable to use Teflon® or Kynar insulator coating on the conductive probe surface when the process fluid is conductive.

Temperature affects both the sensor components inside the vessel (active probes and insulators) and the electronic components and housing outside. An active probe is typically made from stainless steel and, as such (unless it is coated), it is suitable for most applications. Probe insulators can be Teflon®, Kynar, or ceramic, and should be selected for the operating temperature of the application. The housing and the electronics are affected by both the internal and external vessel temperatures.

Ambient temperature limits usually are specified by the manufacturer, but heat conduction from a high-temperature process is more difficult to evaluate. Heat conduction can be reduced by using an extended mounting coupling or one made of a

low thermal conductivity material. If such methods are insufficient, the electronics may be mounted up to 20 ft away and connected via coaxial cable. The cable's inherent capacitance, however, reduces the overall sensitivity of the system.

Housings must also be compatible with the requirements for hazardous, wash-down, wet, and/or dusty environments. Explosion-proof environments may require the housing to be certified. In addition, the active probe might need to be intrinsically safe.

If the process material is corrosive to stainless steel, the probe should be coated with Kynar or Teflon® for protection. Ryton is a good choice for abrasive materials, and, for food grade or sanitary applications, stainless steel and Teflon® are a good probe-insulator combination.

### Installation Considerations

The capacitance probe should be mounted in such a way that its operation is unaffected by incoming or outgoing material flow (Figure 8-5A). Material impacts can cause false readings or damage to

the probe and insulator. When measuring low-dielectric materials, it's important that the entire probe be covered, not just the tip (Figure 8-5C). When rod or cable extensions are used, allow for 8-12 in. of active probe coverage.

Install the probe so that it does not contact the vessel wall (Figure 8-5B) or any structural elements of the vessel. If a cable extension is used, allow for swinging of the cable as the material level in the vessel rises, so that the plumb bob on the end of the cable does not touch the vessel wall. The probe should not be mounted where material can form a

bridge between the active probe and the vessel wall. In addition, the probe should not be mounted at an upward angle (Figure 8-5D), to avoid material build-up.

If more than one capacitance level sensor is mounted in the vessel, a minimum distance of 18 in. should be provided between the probes (Figure 8-5E). Closer than that and their electromagnetic fields might interfere. If a capacitance probe is installed through the side wall of a vessel and the weight of the process material acting on the probe is sometimes excessive, a protective baffle should be installed above the sensor (Figure 8-4A). 

### References & Further Reading

- *OMEGA Complete Flow and Level Measurement Handbook and Encyclopedia*®, OMEGA Press, 1995.
- *OMEGA Volume 29 Handbook & Encyclopedia, Purchasing Agents Edition*, OMEGA Press, 1995.
- *Instrument Engineer's Handbook*, Bela Liptak, Third Edition, CRC Press, 1995.
- *Instrumentation for Process Measurement and Control*, Third Edition, N. A. Anderson, Chilton, 1980.
- *Measurement and Control of Liquid Level*, C. H. Cho, Instrument Society of America, 1982.
- *Principles of Industrial Measurement for Control Applications*, E. Smith, Instrument Society of America, 1984.

# Radiation-Based Level Gages

An entire class of level instrumentation devices is based on a material's tendency to reflect or absorb radiation. For continuous level gages, the most common types of radiation used are radar/microwave, ultrasonic, and nuclear. Optical electromagnetic radiation also can be used, but this has found its way primarily into the point-switch applications discussed in the next chapter.

The main advantage of a radiation-based level gage is the absence of moving parts and the ability to detect level without making physical contact with the process fluid. Because they can in effect "see" through solid tank walls, nuclear radiation gages are perhaps the ultimate in non-contact sensing. Because they require a gamma radiation source and are relatively expensive, however, nuclear gages are often considered the level gage of last resort.

## Radar & Microwave

In 1925, A. Hoyt Taylor and Leo Young of the U.S. Navy used radar (Radio Detection And Ranging) to measure the height of the earth's ionosphere. By 1934, they were developing radar for Navy ships. In 1935, Robert Watson-Watt of England used radar to detect aircraft. The first radar level sensors were introduced in 1976, but they did not become economically competitive until a decade later.

Both radar signals and microwaves travel at the speed of light, but are distinguished by their frequencies (FM radio broadcast frequency is from 88 to 108 MHz, while

microwaves range from 1-300 GHz) and by their power levels (radar is around 0.01 mW/cm<sup>2</sup>, while microwaves range from 0.1-5 mW/cm<sup>2</sup>). Because microwaves operate at a higher energy level, they can withstand more coating than can radar-type sensors.

Radar sensors consist of a transmitter, an antenna, a receiver with

level. Time of flight is the period between the transmission of the radar pulse and the reception of the return echo. It is determined by the radar detector, which is simultaneously exposed to both the sent and the reflected signal. The detector output is based on the difference. The frequency-modulated (FM) signal

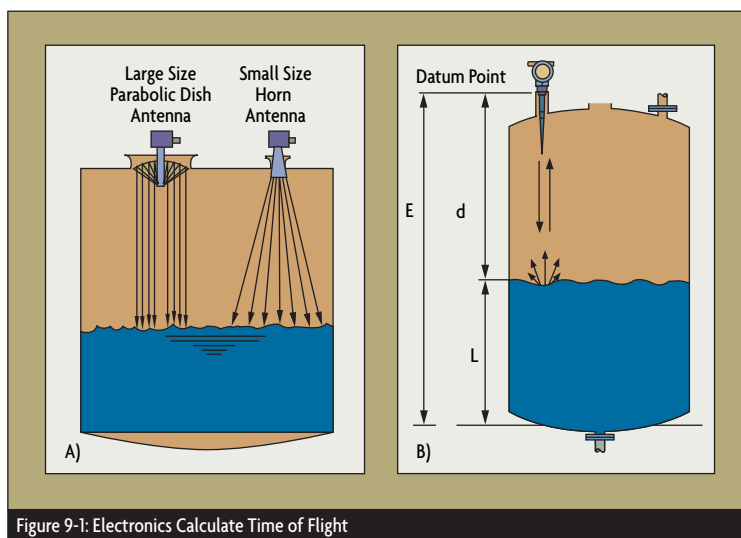

Figure 9-1: Electronics Calculate Time of Flight

signal processor, and an operator interface. The transmitter is mounted on top of the vessel. Its solid-state oscillator sends out an electromagnetic wave (using a selected carrier frequency and waveform) aimed downward at the surface of the process fluid in the tank. The frequency used is typically 10 GHz.

The signal is radiated by a parabolic dish or horn-type antenna (Figure 9-1A) toward the surface of the process liquid (Figure 1B). A portion is reflected back to the antenna, where it is collected and routed to the receiver. Here, a microprocessor calculates the time of flight and calculates the

varies from 0 to 200 Hz as the distance to the process fluid surface varies between 0 and 200 ft. Because this measurement takes place in the frequency domain, it is reasonably free of noise interference.

The depth of the vapor space (the distance between the datum point and the level in the tank, identified as "d" in Figure 9-1B) is calculated from the time of flight (t) and the speed of light (c = 186,000 miles/sec):

$$d = t/2c$$

The level (L in Figure 9-1B) is calculated by figuring the difference between

the total tank height (E) and the vapor space depth (d):

$$L = E - d$$

Knowing the signal velocity (c) and the dielectric constant (dc) of the vapor (that is, the relative ability of the vapor to oppose and reflect electromagnetic waves), the velocity of the radar wave transmission (V) can be calculated:

$$V = c / (dc)^{0.5}$$

• **Antenna Designs and Mounting**

The two commonly used antennas are the horn and the parabolic dish antenna. When the radar level gage sends out its signal, the microwaves spread out. The larger the antenna diameter, the smaller the divergence angle and the greater the signal strength (Figure 9-1A). The disadvantages of smaller antennas include higher beam spreading and the correspondingly increased possibility of reflection from obstacles within the tank. On the positive side, there is a greater chance that the emitted beam will be reflected back to the detector. Therefore, alignment of the sensor is not as critical.

Large antennas generate a more focused signal, helping to eliminate noise interference from flat and horizontal metal surfaces. On the other hand, they are more prone to errors caused by unwanted reflections from turbulent or sloping surfaces. A fully isolated antenna mounted outside the tank (Figures 9-2 and 9-4) provides both sealing and thermal isolation. If the antenna is positioned below the process seal, it is exposed to the process vapors, but gains the advantages of stronger signal amplitudes and suitability for higher operating pressures.

• **Contact & Non-Contact Radar**

Non-contact radar gages either use pulsed radar waves or frequency-modulated continuous waves (FMCW). In the first, short-duration radar pulses are transmitted and the target distance is calculated using the transit time. The FMCW sensor sends out continuous frequency-modulated signals, usually in successive (linear) ramps. The frequency

to be partially reflected. The time-of-flight is then measured (Figure 9-2B). The unreflected portion travels on to the end of the probe and provides a zero-level reference signal. Contact radar technology can be used on liquids and on small-grained bulk solids with up to 20-mm grain size.

Reflection-type microwave switches measure the change in amplitude of a reflected signal (Figure 9-3A). Air

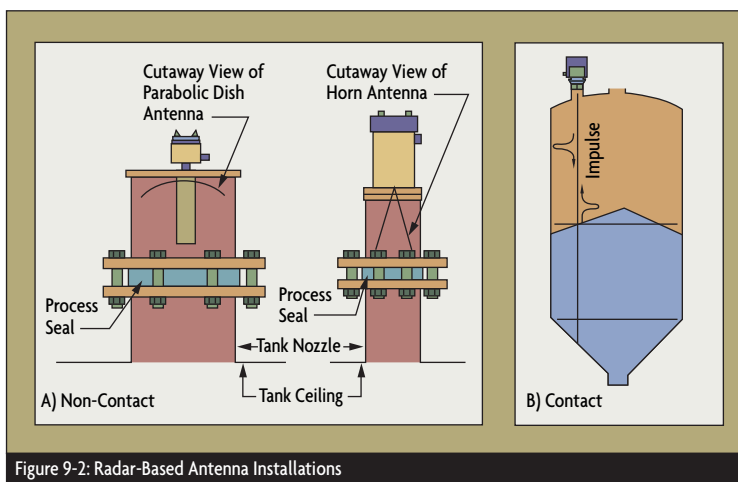

Figure 9-2: Radar-Based Antenna Installations

difference caused by the time delay between transmittal and reception indicates the distance.

Radar beams can penetrate plastic and fiberglass; therefore, non-contact radar gages can be isolated from the process vapors by a seal. The seal can be above the parabolic disc (Figure 9-1A) or can totally isolate the sensor (Figure 9-2A). The beam's low power allows for safe installation in both metallic and non-metallic vessels. Radar sensors can be used when the process materials are flammable or dirty and when the composition or temperature of the vapor space varies.

Contact radar gages send a pulse down a wire to the vapor-liquid interface. There, a sudden change in the dielectric constant causes the signal

and vapors return a small percentage of the signal because of their low dielectric constants, while high dielectric materials such as water return almost all the signal. More sensitive switches can distinguish liquid-liquid or liquid-solid interfaces having as little as 0.1 difference in dielectric constant. Low dielectric materials like plastic pellets (dielectric 1.1) can be measured if the particle diameter is less than 0.1 in (larger than that, excessive beam scattering occurs).

The beam-breaker switch sends a microwave beam from a transmitter to a receiver located on the opposite side of the tank. When the beam is blocked, the signal is weakened (Figure 9-3B). Beam-breaker alignment is not critical, and separation distance can be up to 100 ft.

Both reflection and beam-breaker microwave switches are typically used in applications where it is desirable not to penetrate the tank. These non-intrusive sensors send electromagnetic radio waves through plastic, ceramic or glass windows, or through fiberglass or plastic tank walls.

• **Advantages & Limitations**

The reflective properties of the process material affect the returned radar signal strength. Whereas liquids have good reflectivity characteristics, solids do not. Radar can detect the liquid level under a layer of light dust or airy foam, but if the dust particle size increases, or if the foam or dust gets thick, it will no longer detect the liquid level. Instead, the level of the foam or dust will be measured.

Internal piping, deposits on the antenna, multiple reflections, or reflections from the wall can all interfere with the proper operation of a radar sensor. Other sources of interference are rat-holing and bridging of solids, as well as angled process

advantages. For example, ultrasonic sensors are affected by the composition of the vapor space. On the other hand, ultrasonic sensors perform better in dirty applications, or with solids when the grain size is larger than 20 mm.

**Ultrasonic Level Gages**

The origin of ultrasonic level instrumentation goes back to the echometers used in measuring the depth of wells by firing a blank shell and timing the return of the echo. SONAR detectors used in naval navigation also predate industrial applications of this principle.

The frequency range of audible sound is 9-10 kHz, slightly below the 20-45 kHz range used by industrial level gages. The velocity of an ultrasonic pulse varies with both the substance through which it travels and with the temperature of that substance. This means that if the speed of sound is to be used in measuring a level (distance or position), the substance through which it travels must

sound in atmospheric air is 340 m/s or 762 mph. At that same temperature, an ultrasonic pulse travels through water at 1,496 m/s or 3,353 mph. If the air is heated to 100°C, the speed of sound rises to 386 m/s. Indeed, the speed of sound is proportional to the square root of temperature. At near ambient temperatures, the speed rises by 0.6 m/s per each 1°C increase, corresponding to an increase of 0.18%/°C.

Ultrasonic level switches (point sensors) operate by detecting either dampening of ultrasonic oscillation or by sensing the absorption or transmission of an ultrasonic pulse. Ultrasonic level transmitters measure actual distance by issuing an ultrasonic pulse and measuring the time required for the reflected echo to be received.

• **Ultrasonic Transducers**

The transducer that generates the ultrasonic pulse is usually piezoelectric, although in the past electrostatic units also were used. An electrostatic transducer is constructed of a thin, flexible gold-plated plastic foil,

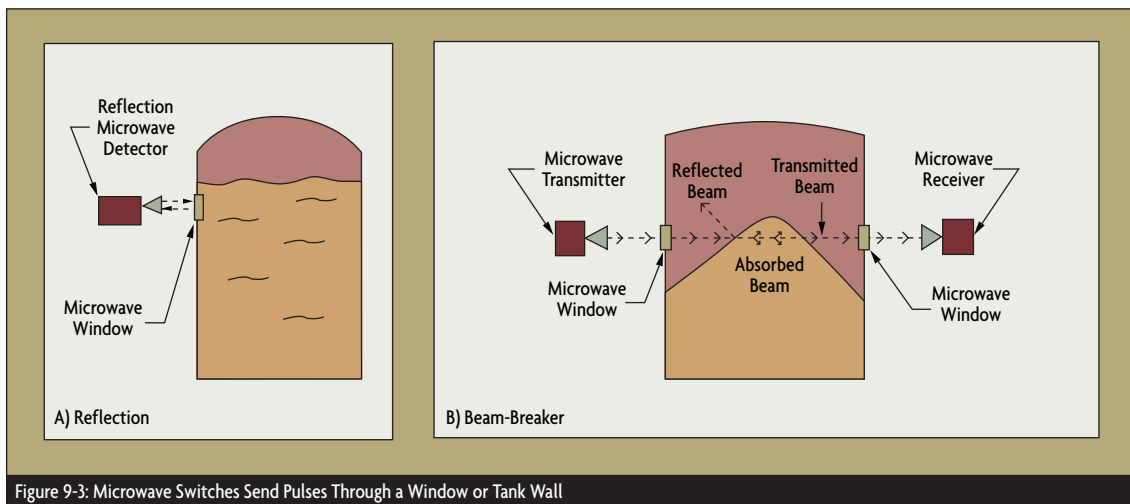

Figure 9-3: Microwave Switches Send Pulses Through a Window or Tank Wall

material surfaces that can reflect the radar beam away from the receiver.

In comparison to other radiation reflection sensors, radar has some

be well known and its temperature variations must be measured and compensated for.

At room temperature, the speed of

stretched over an aluminum backplate and held in place by a leaf spring. This design was used in early Polaroid auto-focus cameras and is

still utilized in clean environments. Piezoelectric transducers utilize

receiver elements (Figure 9-4A). Most often, however, a single transducer is

determine the volume of liquid.

If it is desired to measure the

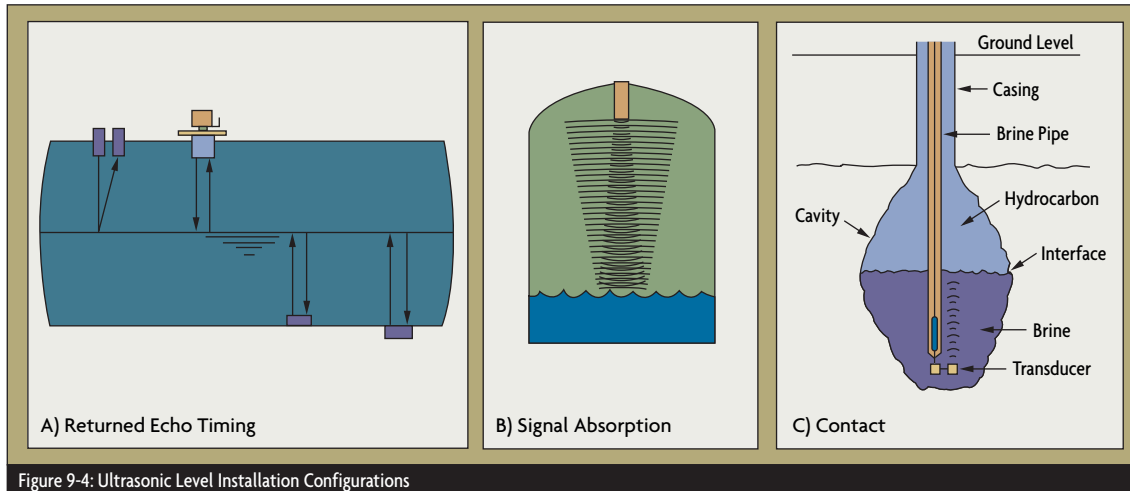

Figure 9-4: Ultrasonic Level Installation Configurations

ceramic or polymer crystals vibrated at their natural frequency. These units are much more rugged, can withstand wash-down pressures of 1,200 psig and can conform to NEMA-6P (IEC IP67) standards.

Generally, the larger the diameter of the transducer, the longer the range and the lower the frequency. This is because, after releasing an ultrasonic pulse, the transducer needs time for the vibration to settle. The oscillation frequency is inversely proportional to the element's diameter, so smaller diameter transducer elements generate higher frequencies. Standard transducers have a beam angle of about 8°, require a connection size between ¼ in and 2.5 in NPT, and are suited for operating temperatures in the range of -20 to 60°C (-30 to 140°F). Accuracy is typically within 0.25-0.5% of full range, up to about 30 ft. Output typically is 4-20 mA with a 12-amp relay output.

• Level Transmitter Configurations

The ultrasonic level sensor assembly can consist of separate transmitter and

cycled on and off at regular intervals to listen for the reflected echo (Figure 9-4A). When mounted on the top of the tank, the sensor detects the depth of the vapor space. Accurate knowl-

height of the liquid column directly, the transducer can be mounted in the bottom of the tank (Figure 9-4A). However, this configuration exposes the transducer to the process fluid and limits accessibility for maintenance. Alternately, the transducer can be mounted on the outside of the wall of the vessel bottom, but the ultrasonic pulse is likely to be substantially weakened by the absorbing and dispersing effects of the tank wall (Figure 9-4A).

Stagnant, unagitated liquids and solids consisting of large and hard particles are good reflectors, and therefore good candidates for ultrasonic level measurement. Fluff, foam, and loose dirt are poor reflectors, and dust, mist, or humidity in the vapor space tend to absorb the ultrasonic pulse. The ultrasonic signal also is attenuated by distance. If a 44-kHz sound wave is traveling in dry, clean ambient air, its sound power drops by 1-3 decibels (dB) for each meter of distance traveled. Therefore it is important, particularly when measuring greater depths,

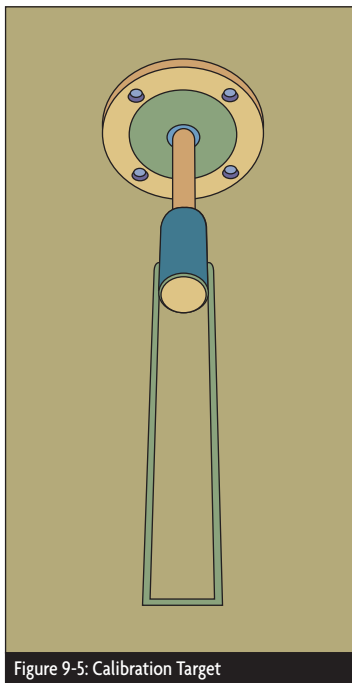

Figure 9-5: Calibration Target

edge of the shape of the tank's cross-section is required in order to

that the transducers generate a strong and well-focused ultrasonic pulse (Figure 9-4B).

It is also desirable that the surface be both flat and perpendicular to the sound wave. In liquid-level applications, the aiming angle must be within 2 degrees of the vertical. If the surface is agitated or sloping (as in the case of solids), the echo is likely to be dispersed. Therefore, the key to

time it takes for the echo to return is an indication of the location of the interface (Figure 9-4C).

• **Special Features**

Most modern ultrasonic instruments include temperature compensation, filters for data processing and response time, and some even provide self-calibration. Figure 9-5 illustrates a fixed target assembly that

which, through multiplexing, can reduce the unit costs of obtaining level measurements.

• **Level Switches**

When it is sufficient to detect the presence or absence of level at a particular elevation, dampened or absorption-type level switches can be considered. In the dampened design, a piezoelectric crystal vibrates the sensor face at

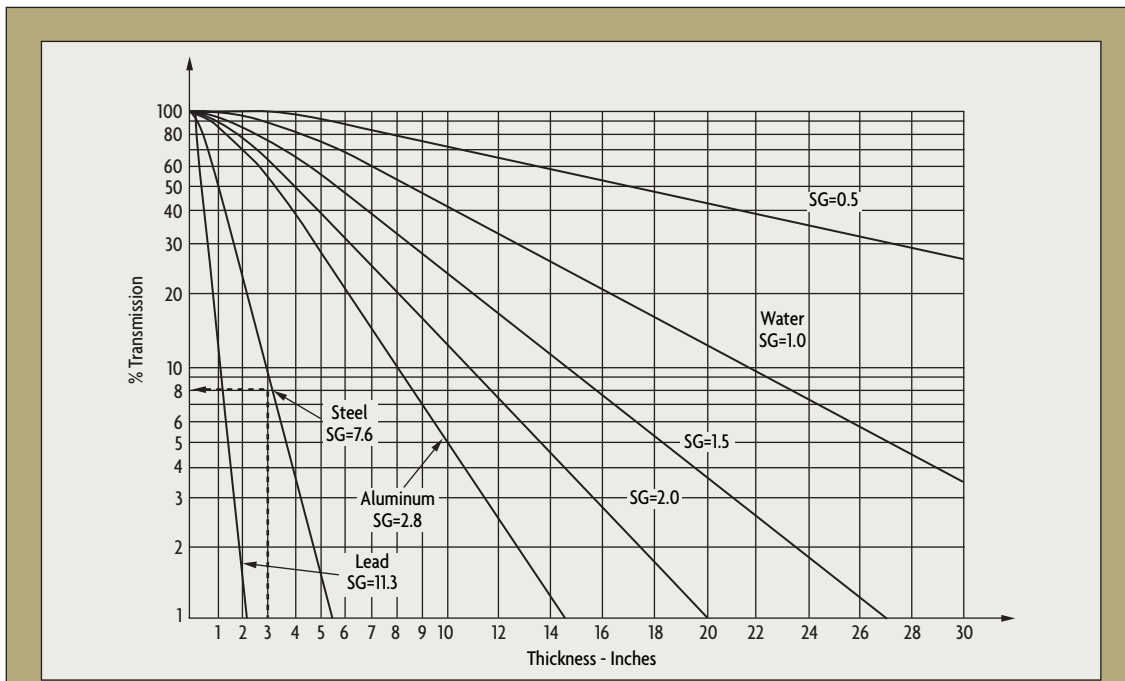

Figure 9-6: Transmission of Gamma Rays Generated by Cesium 137

successful ultrasonic level sensor installations is the careful analysis of the reflection, propagation, and absorption characteristics of the tank's contents.

When detecting the interface between two liquids, such as the hydrocarbon/brine interface in a salt dome storage well, the transducer is lowered down to the bottom of the well. The ultrasonic pulse is sent up through the heavy brine layer to the interface. The

provides a point reference to automatically recalibrate the level sensor. Multiple calibration targets can be provided by calibration ridges in sounding pipes. This can guarantee measurement accuracy of within 5 mm over a distance of 30 meters.

Intelligent units can perform automatic self-calibration or convert the level in spherical, irregular, or horizontal cylindrical tanks into actual volume. They can also be used in multi-tank or multi-silo installations,

its resonant frequency. The vibration is dampened when the probe face is submerged in process fluid. As shown in Figure 9-3A, these switches can be mounted outside or inside the tank, above or below the liquid level. The probe can be horizontal or vertical. These switches are limited to clean liquid installations because coating can dampen the vibration. Solids may not provide sufficient dampening effects to actuate the switch.

In the absorption-type level switch,



one piezoelectric crystal serves as a transmitter and another as the receiver. When the gap between them is filled with liquid, the sonic wave passes from one crystal to the other. When vapors fill the gap, however, the ultrasonic pulse does not reach the

current outputs are also used. The presence or absence of an interface between clean liquids can be measured by inserting an absorption (gap) probe at a 10° angle below the horizontal. In this configuration, as long as the probe is immersed in the

a seemingly solid, impenetrable mass of matter. In the passage, however, the gamma rays lost some of their intensity. The rays were predictably affected by the specific gravity and total thickness of the object, and by the distance between the gamma ray source and the detector.

For example, Figure 9-6 shows that, if radiation from Cesium 137 is passing through an 3-in thick steel object, 92% of the radiation energy will be absorbed and only 8% will be transmitted. Therefore, if the observer can hold all variables *except* thickness constant, the amount of gamma transmission can be used to measure the thickness of the object. Assuming that the distance between the source and detector does not change, one can make accurate measurements of either thickness (level), or, if thickness is fixed, then of the density of a process material.

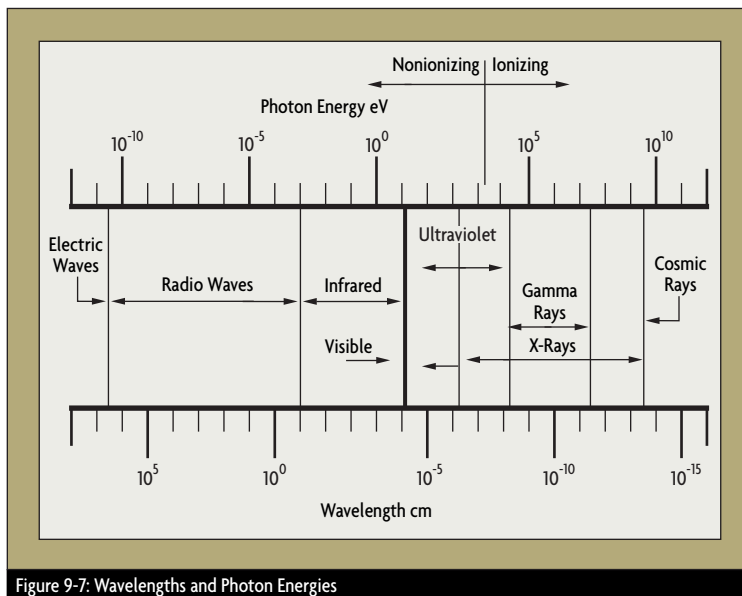

Figure 9-7: Wavelengths and Photon Energies

receiver. The crystals can be mounted on opposite sides of the tank, contained in the fingers of a fork-shaped sensor, or located on the two sides of one or more 0.5-in gaps in a horizontal or vertical probe. When the process fluid is a sludge or slurry, it is desirable to provide a large gap between the transmitter and receiver in order to make sure that sticky or coating fluids will drain completely from the gap when the level drops.

Typical accuracy of these switches is 1/2-in or better. Connection size is 3/4-in NPT. Operating temperature range is 40-90°C (100 to 195°F) (with special units capable of readings up to 400°C/750°F) and operating pressure to 1000 psig. Standard output is a 5 or 10 amp double-pole/double-throw (DPDT) relay, but voltage and

heavy or light liquid, the ultrasonic pulse will reach the receiver. When the interface moves into the gap, however, it is reflected away and does not reach the receiver.

When a sludge or slurry interface is to be detected or when the thickness of the light layer is of interest, an ultrasonic gap sensor can be attached to a float. As long as the absorption characteristics of the two layers differ, the sensor will signal if the layer is thicker or thinner than desired.

### Nuclear Level Sensors

In 1898 Marie Curie discovered radium by observing that certain elements naturally emit energy. She named these emissions gamma rays. Gamma rays exhibited mysterious properties—they could pass through

### • Radiation Sources

The development of nuclear level sensors began when this technology moved from the lab to the industrial environment. This necessitated the design and manufacture of suitable detectors and the mass production of radioisotopes. Both occurred in the 1950s.

The penetrating power of nuclear radiation is identified by its photon energy, expressed in electron volts (eV) and related to wavelength (Figure 9-7). The most common isotope used for level measurement is Cesium 137, which has a photon energy level of 0.56 MeV. Another isotope that is occasionally used is Cobalt 60, which has an energy level of 1.33 MeV. While the greater penetrating power of this higher energy radiation appears attractive at first, the penalty is that it also has a shorter half-life. As any isotope

decays, it loses strength—the time it takes to lose half of its strength is called its half-life.

The half-life of Cobalt 60 is 5.3 years. This means that, in 5.3 years, the activity of a 100 millicurie (mCi) Cobalt 60 source will be reduced to 50 mCi. (One mCi is defined as the rate of activity of one milligram of Radium 226.) When used for level measurement, the continuous loss of source strength requires not only continuous compensation, but, eventually (in the case of Cobalt 60, in about 5 years), the source must be replaced. This means not only the expense of purchasing a new source, but also the cost of disposing of the old one.

In contrast, the 33-year half-life of Cesium 137 is long enough that the source may well outlive the process. Another likelihood is that technological advances will increase the sensitivity of the detector faster than the rate at which the source is decaying. This provides users the option of replacing or upgrading the detector while keeping the source in place for the future.

• **Radiation Safety**

The Nuclear Regulatory Commission (NRC) limits radiation intensity to a maximum of 5 milliroentgens per hour (mr/hr) at a distance of 12 in from the nuclear gage. If it is more, the area requires Radiation Area posting. The distance of 12 in is critical, because radiation intensity decreases by the inverse square of distance. Nuclear level gages are sized to provide radiation intensity at the detector that exceeds the minimum required, but is under the 5 mr/hr maximum. For ion chamber detectors, the minimum is 1 mr/hr. For Geiger-Mueller switches, it is 0.5 mr/hr. And for scintillation detectors, it is 0.1-0.2 mr/hr. Because the nuclear gage is basically measuring the vapor space

above the liquid, as the level rises in the tank, the intensity at the detector drops. When the tank is full, radiation intensity is practically zero.

When used as a tank level sensor, radiation must pass through several layers of material before reaching the detector. At the detector, the maximum radiation must be less than some safety limit (such as 5 mr/hr) to avoid the need for “posting.” Other criteria can be used, such as keeping a yearly dosage under 5 rems (roentgen + equivalent + man). If somebody is exposed to radiation throughout the year, such a dosage will result from exposure to radiation at an intensity of 0.57 mr/hr, while if an operator is exposed for only 40 hrs/wk, 5 rem/yr will correspond to what that

This can be illustrated by an example:

• **Source Sizing**

A point source of 10 mCi Cesium 137 (source constant for Cesium 137 is  $K=0.6$ ) is installed on a high-pressure water tank having 1/2-in steel walls (Figure 9-9). Usually, two criteria need to be satisfied: First, the radiation intensity at the detector must drop by at least 50% as the level rises from 0-100%. The second and more important criterion is that the maximum radiation dose at the detector (when the tank is empty) must not exceed the safety limit (say, 2.4 mr/hr). It must exceed 1.0 mr/hr, however, in order to actuate the intended ion chamber detector.

First the in air intensity ( $D_a$  in

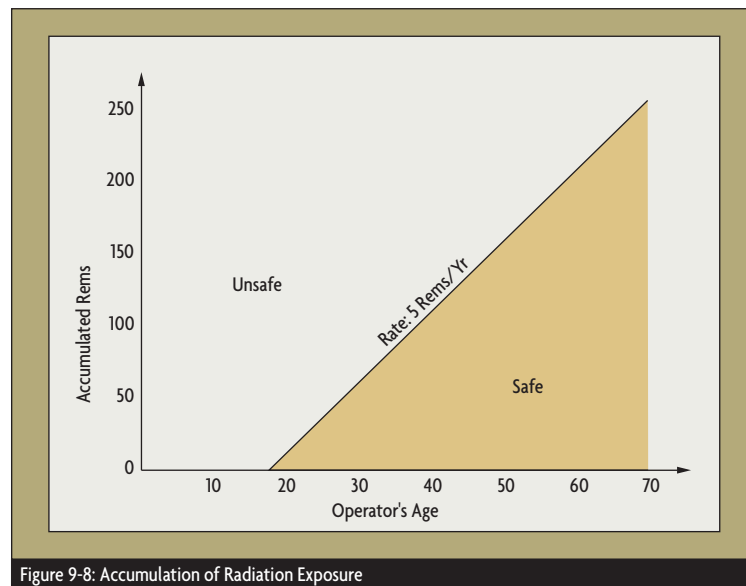

Figure 9-8: Accumulation of Radiation Exposure

person would receive if exposed to 2.4 mr/hr in the work area. As it is the total lifetime dosage of radiation exposure that really matters (maximum of 250 rems), the acceptability of the 5 rem/yr, or any other limit, is also a function of age (Figure 9-8). On the other hand, the radiation at the detector must still be sufficient to produce a usable change in detector output when the level changes.

mr/hr) is calculated at the detector, for the condition when there is no tank between the source and receiver. Assume distance (d) is 48 in:

$$D_a = 1000 K(mCi)/d^2 = 1000(0.6)(10)/48^2 = 2.6 \text{ mr/hr}$$

Because the source is shielded in all directions except towards the tank,

the operator who is working near the detector will receive the maximum dosage when the tank is empty. The two 1/2-in steel walls will reduce  $D_a$  (% transmission of 1-in steel in Figure 1 is 49%) to  $0.49 \times 2.6 = 1.27$  mr/hr. This is below the allowable maximum but above the minimum needed by the detector.

When the tank is full, the presence of 30 in of water in the radiation path will reduce this maximum intensity to  $0.045$  mr/hr ( $0.035 \times 1.9 = 0.045$ ). This reduction in intensity well exceeds the required 50% drop needed for sensitive measurement. Note that the source size could have been cut in half if a Geiger-Mueller detector were used. A scintillation detector would reduce source size 5- to 10-fold.

The source size can also be reduced by locating the source in the tip of a probe inside the tank and moving it relatively close to the wall. When large level ranges are to be measured, a strip source can be used instead of a point source. The accuracy of most nuclear level gages is around 1% of range. If accounting accuracy is desired, the source and the detector can both be attached to motor driven tapes and positioned at the level (or at the interface level, if the tank contains two liquids).

Fortunately, today's computers can easily crunch the numbers and formulas of any combination of geometry and design criteria. The biggest challenge is not the calculation, but the obtaining of accurate inputs for the calculations. Therefore, it is very important that your vessel's wall materials, thicknesses, other tank components such as baffles, agitator blades or jackets, and all distances be accurately determined. In short, the performance of a nuclear gage installation is

very much a function of the accurate knowledge of the installation details.

• **Detector Options**

The simplest and oldest type of radiation detector is the Geiger-Mueller tube. This instrument is most often identified with the Geiger counters that make a loud and dramatic clicking sound when exposed to radiation. The working component of this detector is a metal cylinder that acts as one of the electrodes and is filled with an inert gas. A thin wire down the center acts as the other electrode. Glass caps are

applied. When the tube is exposed to gamma radiation, the gas ionizes and the ionized particles carry the current from one electrode to the other. The more gamma radiation reaches the gas in the tube, the more pulses are generated. The resulting pulse rate is counted by the associated electronic circuitry, which makes measurements in pulses per second.

This detector can be used as a level switch if it is calibrated to engage or disengage a relay when radiation intensity indicates a high or low level condition. The G-M tube

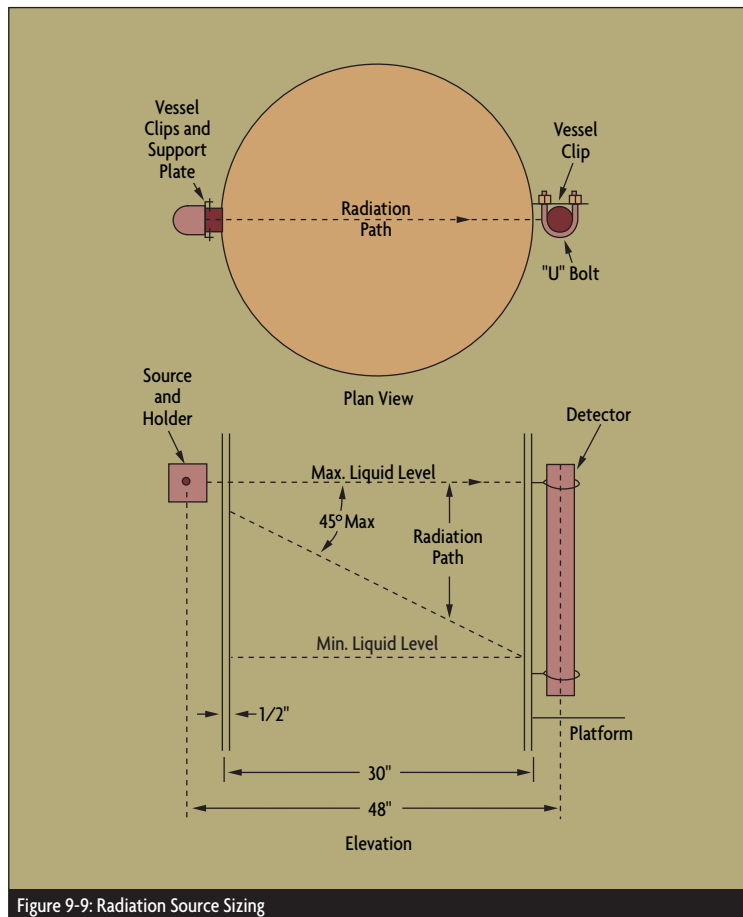

Figure 9-9: Radiation Source Sizing

used as insulators, and a high voltage (700-1000 vdc) nearly sufficient to cause current flow between the elec-

detector can only be used as a single point detection device. Its advantages include its relatively low cost,

small size, and high reliability.

The ion chamber detector is a continuous level device. It is a 4 to 6-in diameter tube up to twenty feet long filled with inert gas pressurized to several atmospheres. A small bias voltage is applied to a large electrode inserted down the center of the ion chamber. As gamma energy strikes the chamber, a very small signal (measured in picoamperes) is detected as the inert gas is ionized. This current, which is proportional to the amount of gamma radiation received by the detector, is amplified and transmitted as the level measurement signal.

In level measurement applications, the ion chamber will receive the most radiation and, therefore, its output will be highest when the level is lowest. As the level rises and the greater quantity of measurand absorbs more gamma radiation, the output current of the detector decreases proportionally. The system is calibrated to read 0% level when the detector current output is its highest. 100% level is set to match the lowest value of the output current. Non-linearities in between can usually be corrected with the use of linearizing software. This software can correct for the effects of steam coils, agitator blades, baffles, stiffening rings, jackets and other components inside or outside the tank.

Scintillation counter detectors are five to ten times more sensitive than ion chambers. They also cost more, yet many users are willing to accept the added expense because it allows them either to use a smaller source size or to obtain a more sensitive gage. When gamma energy hits a scintillator material (a phosphor), it is converted into visible flashes comprised of light photons (particles of light).

These photons increase in number

as the intensity of gamma radiation increases. The photons travel through the clear plastic scintillator medium to a photo multiplier tube, which converts the light photons into electrons. The output is directly proportional to the gamma energy that is striking the scintillator.

Scintillators are available in a multitude of shapes, sizes, and lengths. One of the latest is a fiber optic cable that allows one to increase detector sensitivity by installing more filaments in the bundle. Another advantage of the fiber optic cable is that it is manufactured in long lengths flexible enough to form-fit to the geometry of the vessel. This simplifies the measurement of levels in spherical, conical, or other oddly shaped vessels.

• **Nuclear Applications**

Radiation gages typically are considered when nothing else will work, or when process penetrations required by a traditional level sensor present a risk to human life, to the environment, or could do major damage to property. The liquids and bulk solids

measured by nuclear gages are among the most dangerous, highly pressurized, toxic, corrosive, explosive, and carcinogenic materials around. Because the nuclear gage “sees” through tank walls, it can be installed and modified while the process is running—without expensive down time or chance accidental release.

Because the installation of nuclear sensors requires a Nuclear Regulatory Commission (NRC) license, associated procedures are designed to guarantee that the installation will be safe. The best way to look at the safety aspects of radioactive gaging is to compare the well defined and understood risk represented by exposing the operators to radiation against the possibly larger risk of having an unreliable or inaccurate level reading on a dangerous process.

As detectors become more sensitive and are aided by computers, radiation source sizes and the resulting radiation levels continue to drop. Therefore, the safety of these instruments is likely to continue to improve with time. T

**References & Further Reading**

- *OMEGA Complete Flow and Level Measurement Handbook and Encyclopedia*®, OMEGA Press, 1995.
- *OMEGA Volume 29 Handbook & Encyclopedia, Purchasing Agents Edition*, OMEGA Press, 1995.
- *Automated Process Control Electronics*, John Harrington, Delmar Publishing Inc., 1989.
- *Fundamentals of Radar Techniques for Level Gauging*, Detlef Brumbi, Krohne Metetechnik GmbH & Co. KG, 1995.
- *Industrial Applications of Radar Technology for Continuous Level Measurement*, W. L. Hendrick, Instrument Society of America, 1992.
- *Instrument Engineer's Handbook*, Bela Liptak, Third Edition, CRC Press, 1995.
- *Process/Industrial Instruments and Controls Handbook*, 4th Edition, Douglas M. Considine, McGraw-Hill, 1993.
- *Theoretical Nuclear Physics Volume I: Nuclear Structure*, New York, A. deShalit, H. Feshback, John Wiley & Sons, 1974.

• Thermal Switches

• Vibrating Switches

• Optical Switches

# Specialty Level Switches

**T**hermal, vibrating, and optical level switches are specialty devices developed to solve specific level detection problems. Typically, they are used in applications that either cannot be handled by the more common float and probe-type devices, or when ultrasonic, nuclear, radar or microwave designs would be too sophisticated, expensive, or otherwise unsuited for the task.

All three types can be used to detect liquid levels or interfaces between liquids. The optical level switch is also suited for detecting high foam levels, if it is spray washed after each event. In some specialized applications, all three of these switches have been tuned to identify specific materials or to determine when a material reaches a particular viscosity, density, opacity, or thermal conductivity condition.

All three level switch designs are simple, straightforward, and reliable. Although some can detect other process properties besides level, their main purpose is to measure the presence or absence of material at a particular level in a tank.

These switches are good candidates for use in multiple purpose processing equipment where they must be compatible with a variety of process materials and process conditions. They do not require recalibration between batches and can be cleaned in place.

Vibrating probe-type sensors are often used to detect solid materials such as powders, bulk solids, grain, flour, plastic granules, cement, and fly ash. They provide excellent performance as high or low level switches

and can be mounted from the tops or sides of tanks. The low thermal conductivity of solids and the dusty atmospheres that are likely to exist in the vapor space of solids bins tend to exclude the use of optical and thermal switches from most solids level measurement applications.

When solid materials rat-hole or bridge, few level sensors (except load

after each high level episode. Thermal switches can continue to work when lightly coated, but build-up does usually add a thermally insulating layer, ultimately slowing response time.

Of the three level-switch designs discussed in this chapter, only the laser-based optical level switch is appropriate for use in molten metal

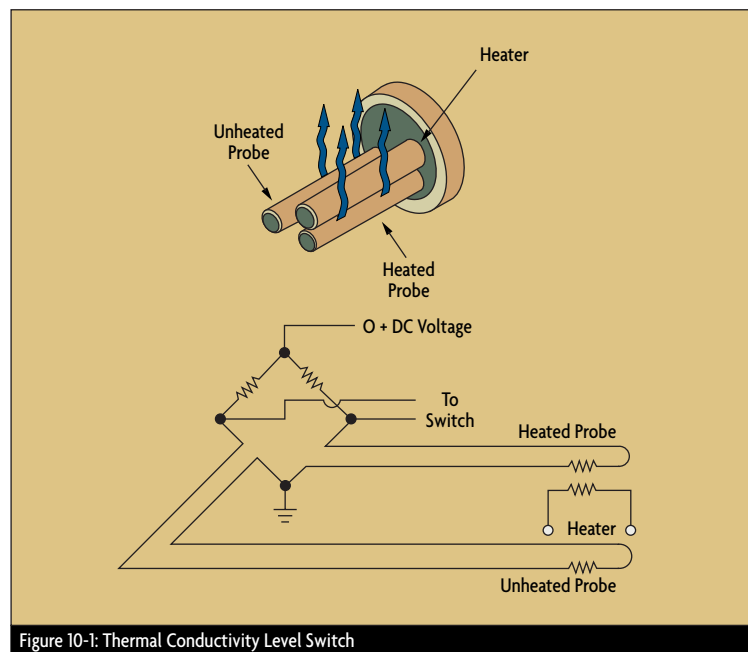

Figure 10-1: Thermal Conductivity Level Switch

cells or radiation devices) work well. The performance of vibrating probe and tuning-fork sensors is also questionable in such services, but their vibrating nature can help to collapse the bridges or to break up the rat-holes.

Vibrating and tuning fork probes can tolerate a fair amount of material build-up, or, if coated with Teflon®, can be self-cleaning in some less difficult services. Optical level switches are available with automatic washers to remove the build-up of coating

level detection. Of the other level sensor technologies, refractory floats, refractory bubbler tubes, and proximity-type capacitance detectors also are used in molten metal service.

## Thermal Switches

Thermal level switches sense either the difference between the temperatures of the vapor space and the liquid or, more commonly, the increase in thermal conductivity as a probe becomes submerged in the process liquid.

One of the simplest thermal level switch designs consists of a temperature sensor heated with a constant amount of heat input. As long as the probe is in the vapor space, the probe remains at a high temperature, because low-conductivity vapors do not carry much heat away from the probe. When the probe is submerged, the liquid absorbs more heat and the probe temperature drops. The switch is actuated when this change in temperature occurs.

Another type of thermal sensor uses two resistance temperature detectors (RTDs), both mounted at the same elevation. One probe is heated and the other provides an unheated reference. The outputs of both sensors are fed into a Wheatstone bridge (Figure 10-1). While the sensor is in the vapor phase, the heated probe will be warmer than the reference probe, and the bridge circuit will be unbalanced. When both probes are submerged in the process liquid, their temperatures will approach that of the liquid. Their outputs will be nearly equal and the bridge will be in balance. This level switch is actuated when a change in bridge balance occurs.

Since all process materials have a characteristic heat transfer coefficient, thermal level switches can be calibrated to detect the presence or absence of any fluid. Therefore, these switches can be used in difficult services, such as interfaces, slurry, and sludge applications. They can also detect thermally conductive foams if spray-cleaned after each operation.

Thermal level and interface switches have no mechanical moving parts and are rated for pressures up to 3,000 psig and process temperatures from -75 to 175°C (-100 to 350°F). When detecting water level, response time is

typically 0.5 second and accuracy is within 2 mm. In general, thermal level switches work best with non-coating liquids and with slurries having 0.4-1.2 specific gravity and 1-300 cP viscosity.

A third type of thermal switch also uses two sensors inside the same vertical probe. One is mounted above the other and both are connected to a voltage source. When both are in the vapor or both in the liquid phase, the current flow

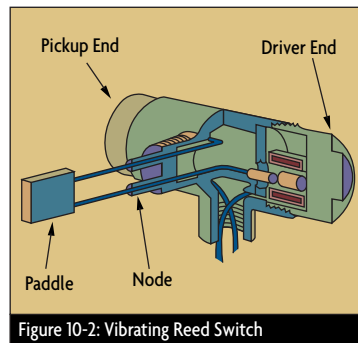

Figure 10-2: Vibrating Reed Switch

through the two sensors is the same. If, on the other hand, the lower one is in liquid and the upper in vapor, more current will flow through the lower sensor. A current comparator can detect this difference and signal that the sensor has reached the vapor/liquid interface.

One interesting feature of this design is that the sensor capsule can be suspended by a cable into a tank or well, and the sensor output can be used to drive the cable take-up motor. In this fashion, the level switch can be used as a continuous detector of the location of the vapor/liquid interface.

Thermometers also can be used to detect level in higher temperature processes, such as measuring the level of molten steel in casting molds. The thermometers do not actually touch the molten metal; instead, they identify the place where the temperature on the outside of the mold

suddenly increases. This is the level inside the mold. Using multiple sensors spaced vertically, the system can determine the level of molten metal in the mold to within a fraction of an inch.

### Vibrating Switches

Vibrating level switches detect the dampening that occurs when a vibrating probe is submerged in a process medium. The three types of vibrating sensors—reed, probe, and tuning fork—are distinguished by their configurations and operating frequencies (120, 200-400, and 85 Hz, respectively). Their methods of operation and applications are similar. The reed switch consists of a paddle, a driver and a pickup (Figure 10-2). The driver coil induces a 120-Hz vibration in the paddle that is damped out when the paddle gets covered by a process material. The switch can detect both rising and falling levels, and only its actuation depth (the material depth over the paddle) increases as the density of the process fluid drops. The variation in actuation depth is usually less than an inch. A reed switch can detect liquid/liquid, liquid/vapor, and solid/vapor interfaces, and can also signal density or viscosity variations.

When used on wet powders, the vibrating paddle has a tendency to create a cavity in the granular solids. If this occurs, false readings will result, because the sensor will confuse the cavity with vapor space.

It is best to use a reed switch on non-coating applications or to provide automatic spray washing after each immersion in a sludge or slurry. Probe-type vibrating sensors are less sensitive to material build-up or coating. The vibrating probe is a round stainless steel element (resembling a

thermowell) that extends into the material. If Teflon® coated and inserted at an angle, these devices tend to be self-cleaning. Both the drive and the sensor are piezoelectric elements: one causes the vibration and the other measures it. When the probe is buried under the process

PVDF, polypropylene, stainless steel, carbon steel, and aluminum. They are available with Teflon® coatings or in hygienic versions for sanitary applications.

Vibrating sensors can be used to ascertain liquid, solid, and slurry levels. Reed switches can operate at

non-contacting design.

In a non-contacting, reflecting optical sensor, a beam of light is aimed down at the surface of the process material. When the level of this surface rises to the setpoint of the switch, the reflected light beam is detected by a photocell. Both the LED light source and photodetector are housed behind the same lens.

By adjusting the photocell or the detection electronics, the sensor can be calibrated to detect levels at distances 0.25 to 12 in below the sensor. These reflective switches can measure the levels of clear as well as translucent, reflective, and opaque liquids. Some solids also can be detected. By using multiple photocells, a sensor can detect several levels.

Laser light also can be used when making difficult level measurements, such as of molten metals, molten glass, glass plate, or any other kind of solid or liquid material that has a reflecting surface. If the receiver module is motor driven, it can track the reflected laser beam as the level rises and falls, thereby acting as a continuous level transmitter.

A refracting sensor relies on the principle that infrared or visible light changes direction (refracts) when it passes through the interface between two media. When the sensor is in the vapor phase, most of the

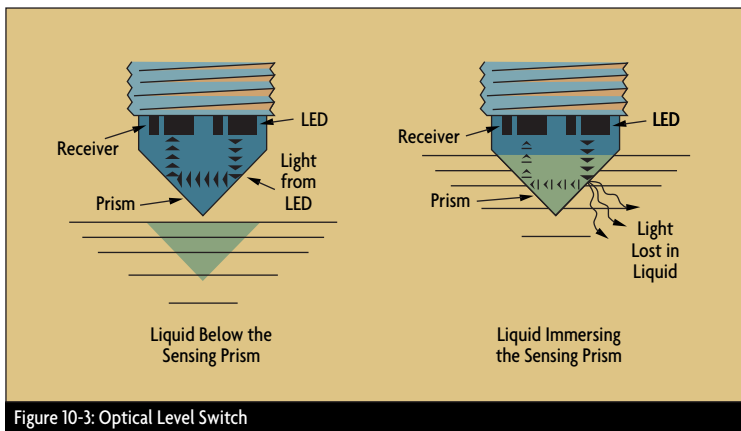

Figure 10-3: Optical Level Switch

material, its vibration is dampened and this decrease triggers the switch.

Vibrating probe sensors can be used to monitor powders, bulk solids, and granular materials such as grain, flour, plastic pellets, cement, and fly ash. Their vibrating nature tends to minimize the bridging that occurs in solid materials. Tuning fork sensors are vibrated at about 85 Hz by one piezoelectric crystal, while another piezoelectric crystal detects the vibration. As the process fluid rises to cover the tuning forks, the vibration frequency changes.

Like vibrating probes, tuning-fork designs can be self-cleaning if Teflon® coated and installed at an angle. They can also be calibrated to detect a wide range of materials, including lubricating oils, hydraulic fluids, water, corrosive materials, sand, thick and turbulent fluids, powders, light granules, and pastes.

Tuning-fork sensors can be constructed with components made of

pressures up to 3,000 psig, while tuning forks and vibrating probes are limited to 150 psig. Operating temperatures range from -100 to 150°C (-150 to 300°F) and response time is about 1 second.

### Optical Switches

Using visible, infrared, or laser light, optical sensors rely upon the light transmitting, reflecting, or refracting properties of the process material when measuring its level. The optical level switch can be of a contacting or



Ultrasonic liquid level switches provide a 300:1 signal ratio from dry to wetted state.



light from the LED is reflected back within a prism (Figure 10-3). When the prism is submerged, most of the light refracts into the liquid, and the amount of reflected light that reaches the receiver drops substantially. Therefore, a drop in the reflected light signal indicates contact with the process liquid.

A refracting sensor cannot be used with slurries or coating liquids, unless it is spray-washed after each submersion. Even a few drops of liquid on the prism will refract light and cause erroneous readings. Refracting sensors are designed to be submerged in liquids; therefore, any number of them can be installed on a vertical pipe to detect a number of level points.

Transmission optical sensors send a beam of light across the tank. A sludge level sensor of this design uses an LED and a photocell at the end of a probe, located at the same elevation and separated by a few inches. To find the sludge level, a mechanism (or an operator, manually) lowers the probe into the tank until the sensors

encounter the sludge layer.

Other transmission sensors rely on the refraction principle utilizing an unclad, U-shaped fiber optic cable. A light source transmits a pulsed light beam through the fiber cable, and the sensor measures the amount of light that returns. If liquid covers the cable, it will cause light to refract away from the cable. The use of fiber-optics makes the system impervious to electrical interference, and some designs are also intrinsically safe.

Optical sensors can operate at pressures up to 500 psig and tem-

peratures up to 125°C (260°F). Response time is virtually immediate, and detection accuracy of most designs is within 1 mm. Optical level switches are also designed for specific or unique applications. For example, Teflon® optical level switches are available for sensing the level of ultra-pure fluids. Other unique designs include a level switch that combines an optical with a conductivity-type level sensor to detect the presence of both water (conductive) and hydrocarbons (nonconductive). 

**References & Further Reading**

- *OMEGA Complete Flow and Level Measurement Handbook and Encyclopedia*®, OMEGA Press, 1995.
- *OMEGA Volume 29 Handbook & Encyclopedia, Purchasing Agents Edition*, OMEGA Press, 1995.
- *Industrial Control Handbook*, E.A. Parr, Butterworth-Heinemann Ltd., 1995.
- *Instrument Engineer's Handbook*, Bela Liptak, Third Edition, CRC Press, 1995.
- *Process/Industrial Instruments and Controls Handbook*, 4th Edition, Douglas M. Considine, McGraw-Hill, 1993.
- *The McGraw-Hill Encyclopedia of Science and Technology*, 8th Edition, John H. Zifcak, McGraw-Hill, 1997.

# Information Resources

<b>ORGANIZATIONS</b>		
<b>NAME/ADDRESS</b>	<b>PHONE</b>	<b>WEB ADDRESS</b>
<b>American Institute of Chemical Engineers (AIChE)</b> 345 East 47 Street, New York NY 10017-2395	(212)705-7338	www.aiche.org
<b>American Gas Association (AGA)</b> 400 N. Capitol St., NW Washington DC 20001	(202)824-7000	www.aga.org
<b>American National Standards Institute (ANSI)</b> 11 West 42 Street, New York NY 10036	(212)642-4900	web.ansi.org
<b>American Petroleum Institute (API)</b> 1220 L Street, NW, Washington DC 20005	(202)682-8000	www.api.org
<b>American Society of Mechanical Engineers (ASME)</b> 345 East 47 Street, New York NY 10017	(212)705-7722	www.asme.org
<b>American Society for Testing and Materials (ASTM)</b> 100 Barr Harbor Drive, West Conshohocken PA 19428-2959	(610)832-9585	www.astm.org
<b>American Water Works Association (AWWA)</b> 6666 West Quincy Ave., Denver CO 80235	(303)794-7711	www.awwa.org
<b>Canadian Gas Association (CGA)</b> 243 Consumers Road, Suite 1200, North York Canada M2J 5E3 ON	(416)498-1994	www.cga.ca
<b>Electric Power Research Institute (EPRI)</b> 3412 Hillview Avenue, Palo Alto CA 94303	(415)855-2000	www.epri.com
<b>Electronic Industries Association (EIA)</b> 2500 Wilson Boulevard, Arlington VA 22201-3834	(703)907-7500	www.eia.org
<b>Factory Mutual</b> 1151 Boston-Providence Turnpike, Norwood MA 02062	(781)762-4300	www.factorymutual.com
<b>Gas Research Institute</b> 8600 West Bryn Mawr Ave., Chicago IL 60631-3562	(773)399-8100	www.gri.org
<b>International Electrotechnical Commission (IEC)</b> 3, rue de Varembe, P.O. Box 131, CH - 1211 Geneva 20, Switzerland	+41 22 919 02 11	www.iec.ch
<b>International Organization for Standardization (ISO)</b> 1, rue de Varembe, Case postale 56, CH-1211 Geneve 20 Switzerland	+41 22 749 01 11	www.iso.ch
<b>Institute of Electrical &amp; Electronics Engineers (IEEE)</b> 445 Hoes Lane, Piscataway NJ 08855-1331	(732)981-0060	www.ieee.org
<b>Institute of Gas Technology (IGT)</b> 1700 South Mount Prospect Road, Des Plaines IL 60018	(847)768-0500	www.igt.org

## ORGANIZATIONS (CONT'D.)

<b>ISA—The International Society for Measurement and Control</b> 67 Alexander Drive, Research Triangle Park NC 27709	(919)549-8411	www.isa.org
<b>National Electrical Manufacturers Association (NEMA)</b> 1300 North 17th Street, Suite 1847, Rosslyn VA 22209	(703)841-3200	www.nema.org
<b>National Fire Protection Association (NFPA)</b> 1 Batterymarch Park, Quincy MA 02269-9101	(617)770-3000	www.nfpa.org
<b>National Institute of Standards and Technology</b> Gaithersburg MD 20899-0001	(301)975-3058	www.nist.gov
<b>Society of Automotive Engineers (SAE)</b> 400 Commonwealth Drive, Warrendale PA 15096-0001	(724)776-4841	www.sae.org
<b>Underwriters Laboratories</b> 333 Pflugsten Road, Northbrook IL 60062	(847)272-8800	www.ul.com
<b>Water Environment Federation (WEF)</b> 601 Wythe Street, Alexandria VA 22314-1994	(703)684-2452	www.wef.org

## FLOW AND LEVEL PRODUCTS

**For the Latest Information on Flow and Level Products:**

OMEGA Engineering, Inc.  
One Omega Drive  
P.O. Box 4047  
Stamford CT 06907-0047  
Phone: 800-82-66342  
(800-TC-OMEGA®)  
Email: info@omega.com  
Website: www.omega.com



## OMEGA PRESS REFERENCES

*The Temperature Handbook™ Volume MM™ 21st Century™ Edition*, OMEGA Press, 1999.

*The OMEGA Complete Flow and Level Measurement Handbook and Encyclopedia®*, OMEGA Press, 1995.

*The Pressure, Strain and Force Handbook™*, OMEGA Press, 1995.

*Book of Books®: Scientific & Technical Books, Software & Videos*, OMEGA Press, 1998.

*OMEGA Volume 29 Handbook & Encyclopedia, Purchasing Agents Edition*, OMEGA Press, 1995

*21st Century™ Preview Edition*, OMEGA Press, 1997

## OTHER REFERENCE BOOKS

*Applied Fluid Flow Measurement*,  
N.P. Cheremisinoff, Marcel Decker, 1979.

*Automated Process Control Electronics*,  
John Harrington, Delmar Publishing Inc., 1989.

*Differential Producers - Orifice, Nozzle, Venturi*,  
ANSI/ASME MFC, December 1983.

*Electrical Measurements and Measuring Instruments*,  
E.W. Goldin, Pitman and Sons, 1948.

*Electrical Measurements*,  
F.K. Harris, Wiley, 1952.

*Flow Measurement Engineering Handbook*,  
R.W. Miller, McGraw Hill, 1996.

*Flow Measurement for Engineers and Scientists*,  
N.P. Cheremisinoff, Marcel Dekker, 1988.

*Flow Measurement*,  
Bela Liptak, CRC Press, 1993.

*Flow Measurement*,  
D.W. Spitzer, Instrument Society of America, 1991.

*Flow of Water Through Orifices*,  
AGA/ASME, Ohio State Univ. Bulletin 89, Vol. IV, No.3.

*Flowmeters*,  
F. Cascetta, P. Vigo, ISA, 1990.

*Fluid Meters*,  
H.S. Bean, American Society of Mechanical Engineers, 1971.

*Fundamentals of Flow Measurement*,  
J. P. DeCarlo, Instrument Society of America, 1984.

*Fundamentals of Radar Techniques for Level Gauging*,  
Detlef Brumbi, Krohne Mettechnik GmbH & Co. KG, 1995.

*Incompressible Flow*,  
Donald Panton, Wiley, 1996.

*Industrial Applications of Radar Technology for Continuous Level Measurement*,  
W. L. Hendrick, Instrument Society of America, 1992.

*Industrial Control Handbook*,  
E.A. Parr, editor, Butterworth-Heinemann Ltd., 1995.

*Industrial Flow Measurement*,  
D. W. Spitzer, ISA 1984.

*Instrument Engineer's Handbook*,  
Bela Liptak, Third Edition, CRC Press, 1995.

*Instrumentation and Control*,  
C.L. Nachtigal, Wiley, 1990.

*Instrumentation and Process Control*,  
Nicholas P. Chopey, McGraw-Hill, 1996.

**OTHER REFERENCE BOOKS**

- Instrumentation for Engineering Measurements*,  
J. Dally, Wiley, 1993.
- Instrumentation for Process Measurement and Control*, 3rd ed.,  
Norman A. Anderson, Chilton Co., 1980.
- Instrumentation Reference Book*, 2nd ed.,  
B.E. Noltingk, editor, Butterworth-Heinemann, 1995.
- Instruments of Science*,  
Robert Bud and Deborah Jean Warner, Garland Publishing Inc., 1998.
- Measurement and Control Basics*, 2nd ed.,  
T.A. Hughes, ISA, 1995.
- Measurement and Control of Liquid Level*,  
C. H. Cho, Instrument Society of America, 1982.
- Modern Physics*,  
New York, P. Tipler, Worth Publishers, 1978.
- National Electrical Safety Code*,  
IEEE, 1993.
- Principles of Industrial Measurement for Control Applications*,  
E. Smith, Instrument Society of America, 1984.
- Process /Industrial Instruments and Controls*, 4th ed.,  
Douglas M. Considine, McGraw-Hill, 1993.
- Sensor and Analyzer Handbook*,  
H.N. Norton, Prentice-Hall, 1982.
- Sensors and Control Systems in Manufacturing*,  
S. Soloman, McGraw-Hill, 1994.
- The McGraw-Hill Encyclopedia of Science and Technology*, 8th ed.,  
John H. Zifcak, McGraw-Hill, 1997.
- Theoretical Nuclear Physics Volume I: Nuclear Structure*,  
New York, A. deShalit, H. Feshback, John Wiley & Sons, 1974.
- Van Nostrand's Scientific Encyclopedia*,  
Douglas M. Considine, Van Nostrand, 1995.
- Water Meters - Selection, Installation, Testing and Maintenance*,  
Manual M6, AWWA, 1986.

Teflon® Viton® and Kalrez® are registered trademarks of DuPont.

# Glossary

## A

**Accuracy:** Degree of conformity of a measured value to an accepted standard value; or closeness of a reading or indication of a sensor to the actual value of the quantity being measured.

**Accuracy rating:** A number that defines a limit that the measurement errors will not exceed under some reference operating conditions. It includes the combined effects of conformity, hysteresis, deadband and repeatability errors.

**Accuracy, units:** The maximum positive or negative deviation (inaccuracy) observed in testing a device. It can be expressed in terms of the measured variable ( $\pm 1^\circ\text{C}$ ), or as a percentage of the actual reading (%AR), of the full scale (%FS), of upper range value (%URL), of the span or of scale length.

**Admittance:** Admittance of an ac circuit is analogous to conductivity of a dc circuit; it is the reciprocal of the impedance of an ac circuit.

**Air consumption:** The maximum rate at which air is consumed by an instrument while operating within its operating range, usually expressed in units of standard cubic feet per minute.

**Alphanumeric:** A character set containing both letters and numbers.

**Alternating current (ac):** A flow of electric charge (electric current) that undergoes periodic reverses in direction. In North America, household current alternates at a frequency of 60 times per second.

**Ambient pressure:** The atmospheric pressure of the medium surrounding a particular sensor. When no specific information is available, it is assumed to be 14.7 psia.

**Ambient temperature:** The average or mean temperature of the atmospheric air which is surrounding a sensor or instrument. If the sensor is a heat generator, this term refers to the temperature of the surroundings when the sensor is in operation. The ambient temperature is usually stated under the assumption that the sensor is not exposed to the sun or other radiant energy sources.

**Ambient temperature compensation:** An automatic correction which prevents the reading of a sensor or instrument from being affected by variations in ambient temperature. The compensator specifications state the temperature range within which the compensation is effective.

**American National Standards Institute (ANSI):** A professional organization in the United States responsible for accepting and designating the standards developed by other organizations as national standards.

**Ampere (A or amp):** The unit of electric current flow, defined as the rate at which one coulomb of electric charge ( $6.25 \times 10^{18}$  electrons) is transferred in a second.

**Amplifier:** A device that generates an output which is stronger than and bears some predetermined relationship (often linear) to its input. It generates the amplified output signal while drawing power from a source other than the signal itself.

**Analog signal:** A signal that continuously represents a variable or condition.

**Analog-to-digital (A/D) conversion:** A generic term referring to the conversion of an analog signal into a digital form.

**Analog-to-digital converter (ADC):** An electronic device that converts analog signals to an equivalent digital form.

**Attenuation:** The reciprocal of gain; a dimensionless ratio defining the decrease in magnitude of a signal as it passes between two points or two frequencies. Large values of attenuation are expressed in decibels (dB).

## B

**Backlash:** The relative movement of interlocked mechanical parts that occurs when motion is reversed.

**Baud rate:** Serial communications data transmission rate expressed in bits per second (bps).

**Bipolar:** A signal range that includes both positive and negative values (*i.e.*, -10 V to +10 V).

**Bode diagram:** A plot of log amplitude ratio and phase angle values used in describing transfer functions.

**Breakdown voltage:** Threshold voltage at which circuit components begin to be damaged.

**Byte (B):** Eight related bits of data or an eight-bit binary number. Also denotes the amount of memory required to store one byte of data.

## C

**Calibrate:** To ascertain that the output of a device properly corresponds to the information it is measuring, receiving or transmitting. This might involve the location of scale graduations, adjustment to bring the output within specified tolerance or ascertaining the error by comparing the output to a reference standard.

**Calibration:** The process of adjusting an instrument or compiling a deviation chart so that its reading can be correlated to the actual values being measured.

**Calibration curve:** A graphical representation of the calibration report, which report can be in the form of a table or chart.

**Calibration cycle:** The application of known values of a measured variable and the recording of the corresponding output readings over the range of the instrument in both ascending and descending directions.

**Calibration traceability:** The relationship of the calibration process to the calibration steps performed by a national standardizing laboratory.

**Capacitance:** The capability of a device to store electric charge. The unit is the farad, which expresses the ratio of stored charge in coulombs to the impressed potential difference in volts.

**Capacitor:** A device designed to store electric charge. It usually consists of two conductors that are electrically isolated by a nonconductor (dielectric). The plates of a perfect capacitor are isolated by vacuum (dielectric constant of 1.0), in which case no current flows between the plates.

**Common mode rejection:** The ability of a circuit to discriminate against a common mode voltage.

**Common mode voltage:** A voltage of the same polarity on both sides of a differential input relative to ground.

**Compensator:** A device that eliminates the effect of an unmeasured variable or condition on the measurement of interest.

**Compound detector:** A detector whose measurement range extends both above and below zero.

**Conductance; Conductivity:** The reciprocal of resistance in a dc circuit is conductance. The unit is the mho. The unit of conductivity is cm-mho or cm/ohm.

**Controller:** A device that operates automatically to regulate a controlled variable.

**Coulomb:** The amount of electric charge transferred in one second by a current flow of one ampere.

**D**

**Damping:** The suppression of oscillation. The viscosity of a fluid is used in viscous damping, while the induced current in electrical conductors is used to effect magnetic damping.

**Deadband:** The range through which an input can be changed without causing an observable response.

**Dead time:** The interval between the initiation of a change in the input and the start of the resulting

observable response.

**Decibel (dB):** Unit for expressing a logarithmic measure of the ratio of two signal levels.

**Dielectric:** A non-conductor of dc current.

**Dielectric constant:** A numeral that expresses the degree of non-conductivity of different substances, with full vacuum defined as 1.0.

**Distributed control system (DCS):** Typically, a large-scale process control system characterized by a distributed network of processors and I/O subsystems that encompass the functions of control, user interface, data collection, and system management.

**Dither:** A useful oscillation of small magnitude, introduced to overcome the effects of friction, hysteresis, or clogging.

**Drift:** Undesired change in the input-output relationship over a period of time.

**Dynamic range:** Ratio of the largest to the smallest signal level a circuit can handle, normally expressed in dB.

**E**

**Electromotive force:** Force that causes the movement of electricity, such as potential difference of voltage. A measure of voltage in an electrical circuit.

**Elevation:** A range in which the zero value of the measured variable exceeds the lower range value.

**Error:** The difference between the measured signal value or actual reading and the true (ideal) or desired value.

**Error, common mode:** Error caused by interference that appears between both measuring terminals and ground.

**Error, normal mode:** Error caused by interference that appears between the two measuring terminals.

**Error, random:** The amount of error that remains even after calibrating a sensor. Also called "precision," while "repeatability" is defined as twice that: the diameter (instead of the radius) of the circle within which the readings fall.

**Error, systematic:** A repeatable error, which either remains constant or varies according to some law, when the sensor is measuring the same value. This type of error can be eliminated by calibration.

**F**

**Farad:** The unit of capacitance, equivalent to one coulomb of stored charge per volt of applied potential difference. As this is a very large unit, one trillionth of it, the picofarad (pf), is commonly used.

**Fieldbus:** All-digital communication network used to



connect process instrumentation and control systems. Designed to replace systems based on 4-20 mA analog signals with bi-directional, multivariable data communication capability.

**Frequency:** The number of cycles over a specified time period during which an event occurs. Normally expressed in cycles per second (hertz, Hz).

**Frequency response:** The frequency-dependent characteristic that determines the phase and amplitude relationship between sinusoidal input and output.

#### G

**Gain (magnitude ratio):** For a linear system or element, the ratio of the magnitude (amplitude) of a steady-state sinusoidal output relative to a causal input. In an electrical circuit, the amount of amplification used, sometime expressed in decibels (dB).

**Gain accuracy:** Measure of deviation of the gain (of an amplifier or other device) from the ideal gain.

**Gain, dynamic:** For a sinusoidal signal, the magnitude ratio of the steady-state amplitude of an output signal to the amplitude of the input.

**Gain, static:** The ratio of change of steady-state value to a step change in input, provided that the output does not saturate.

**Ground:** The electrical neutral line having the same potential as the surrounding earth; the negative side of a direct current power system; the reference point for an electrical system.

#### H

**Hertz (Hz):** The unit of frequency, defined as one cycle per second.

**Hunting:** An undesirable oscillation which continues for some time after an external stimulus has disappeared.

**Hysteresis:** The property of an element or sensor, whereby output is dependent not only on the value of the input, but on the direction of the current traverse. (That is, the reading of the same value differs as a function of whether the measurement is rising or falling.)

#### I

**Impedance:** Opposition to the flow of ac current; the equivalent of resistance in dc circuits. The unit is the ohm. The impedance of an ac circuit is one ohm if a potential difference of one volt creates a current flow of one ampere within it.

**Inductance:** The property by which an electromotive force (emf) is induced in a conductor when the magnetic field is changing about it. This is usually caused by

changes in the current flow in the circuit or in a neighboring circuit.

**Input/output (I/O):** The analog or digital signals entering or leaving a DCS or other central control or computer system involving communications channels, operator interface devices, and/or data acquisition and control interfaces.

**Integral control:** A control mode which generates a corrective output signal in proportion to the time integral of the past error. It eliminates the offset inherent in proportional control.

**Intrinsically safe:** Equipment or wiring which is incapable of releasing sufficient electrical or thermal energy to ignite a hazardous mixture of hydrocarbon vapors and air. In such equipment, the electrical energy is limited so that it cannot generate a spark or otherwise ignite a flammable mixture.

**ISA:** Formerly, The Instrument Society of America; now referred to as the International Society for Measurement & Control.

#### L

**Laser:** Narrow, intense beam of coherent light.

**Linearity:** The closeness to which a curve approximates a straight line, or the deviation of an instrument's response from a straight line.

**Linear stroke:** For a transducer, the calibrated mechanical movement over which its electrical output linearity meets its specifications.

**Loop gain characteristics:** Of a closed loop, the characteristic curve of the ratio of the change in the return signal to the change in the error signal for all real frequencies.

**Loop transfer function:** Of a closed loop, the transfer function obtained by taking the ratio of the Laplace transform of the return signal to the Laplace transform of its corresponding error signal.

**Lower range limit (LRL):** The lowest value of the measured variable that a device can be adjusted to measure.

**Lower range value (LRV):** The lowest value of the measured variable that a device is adjusted to measure.

#### M

**Manipulated variable:** A quantity or condition which is varied as a function of an actuating error signal so as to change the value of the directly controlled variable.

**Measurement signal:** The electrical, mechanical, pneumatic, digital or other variable applied to the input of a device. It is the analog of the measured variable pro-

duced by the transducer.

**Measurement variable:** A quantity, property or condition which is being measured, sometimes referred to as the measurand.

**Milliamp (mA):** One thousandth of an ampere.

**Millivolt (mV):** One thousandth of a volt.

**Multiplexer (Mux):** A switching device that sequentially connects multiple inputs or outputs in order to process several signal channels with a single A/D or D/A converter.

## N

**Noise:** Any undesirable electrical signal, from external sources such as ac power lines, motors, electrical storms, radio transmitters, as well as internal sources such as electrical components.

**Non-linearity:** The deviation from the best fit straight line that passes through zero.

**Normal-mode rejection ratio:** The ability of an instrument to reject electrical interference across its input terminals, normally of line frequency (50-60 Hz).

**Nyquist theorem:** The law that is the basis for sampling continuous information. It states that the frequency of data sampling should be at least twice the maximum frequency at which the information might vary. This theorem should be observed in order to preserve patterns in the information or data, without introducing artificial, lower frequency patterns.

## O

**Ohmmeter:** A device used to measure electrical resistance.

**One-to-one repeater:** A diaphragm-operated device which detects process pressure and generates an air (or nitrogen) output signal of equal pressure.

**Optical isolation:** Two networks or circuits in which an LED transmitter and receiver are used to maintain electrical discontinuity between the circuits.

**Output settling time:** The time required for an analog output voltage to reach its final value within specified limits.

**Output signal:** A signal delivered by a device, element or system.

**Output slew rate:** The maximum rate of change of analog output voltage from one level to another.

**Overtravel:** That part of a stroke which falls between the end of the calibrated range and the travel stop.

## P

**Phase:** A time-based relationship between a periodic function and a reference.

**Phase shift:** The angle in degrees between an energizing

voltage waveform and an output signal waveform.

**Polarity:** In electricity, the quality of having two charged poles, one positive and one negative.

**Port:** A communications connection on an electronic or computer-based device.

**Power supply:** A separate unit or part of a system that provides power (pneumatic, electric, etc.) to the rest of a system.

**Pressure, ambient:** The pressure of the medium surrounding a device.

**Pressure, design:** The pressure used in the design of a vessel or other item of equipment for the purpose of determining the minimum permissible wall thickness or size of parts for a given maximum working pressure (MWP) at a given temperature.

**Pressure, maximum working:** The maximum permissible operating pressure at a specified temperature. This is the highest pressure to which the device will be subjected during regular use.

**Pressure, operating:** The actual (positive or negative) pressure at which a device operates under normal conditions.

**Pressure, rupture:** The burst pressure of a device (determined by testing).

**Pressure, static:** The steady-state pressure applied to a device.

**Pressure, supply:** The pressure at which a utility (such as air) is supplied to a device.

**Pressure, surge:** Operating pressure plus the increment to which a device can be subjected for a very short time during temporary pressure surges caused by such phenomena as pump start-up or valve shut-off.

**Pretravel:** That part of a stroke which falls below the calibrated range, between zero and the travel stop.

**Primary element:** An element that converts a measured variable into a force, motion or other form suitable for measurement.

**Process:** Physical or chemical change of matter or conversion of energy.

**Process measurement:** The acquisition of information that establishes the magnitude of process quantities.

**Programmable logic controller (PLC):** Computer-based industrial monitoring and control package with applications mostly in the areas of safety, sequential or logical operations, where control actions are based on equipment and alarm status.

**Proportional control:** A control mode which generates

an output correction in proportion to error (the process variable's deviation from setpoint).

**Proportional-integral-derivative (PID):** Also referred to as a 3-mode controller, combining proportional, integral, and derivative control actions.

**psia:** Pounds per square inch absolute; the unit of pressure used when the zero reference is full vacuum.

**psig:** Pounds per square inch gauge; the unit of pressure used when the zero reference is the barometric pressure of the atmosphere.

## R

**Radio frequency:** The frequency range between ultrasonic and infrared. AM broadcast frequencies range from 540 to 1,800 kHz, while FM broadcasts from 88 to 108 MHz.

**Radio frequency interference (RFI):** Noise induced upon signal wires by ambient radio-frequency electromagnetic radiation with the effect of obscuring an instrument signal.

**Ramp:** The total (transient plus steady-state) time response resulting from a sudden increase in the rate of change from zero to some finite value of input stimulus.

**Range:** The region between the limits within which a quantity is measured, received or transmitted, expressed by stating lower and upper range values.

**Reactance:** The opposition to the flow of ac current, which is created by either inductance or capacitance. In such a circuit, total impedance is therefore the sum of reactance and resistance. The unit is the ohm.

**Reference input:** An external signal serving as a setpoint or as a standard of comparison for a controlled variable.

**Reliability:** The probability that a device will perform its objective adequately for the period of time specified, under the operating conditions specified.

**Repeatability:** The maximum difference between output readings when the same input is applied consecutively; the closeness of agreement among consecutive measurements of an output for the same value of input under the same operating conditions, approaching from the same direction, usually measured as non-repeatability and expressed as percent of span.

**Reproducibility:** The closeness of agreement among repeated measurements of an output for the same value of input made under the same operating conditions over a period of time, approaching from both directions. It includes hysteresis, deadband, drift and repeatability.

**Resistance; Resistivity:** The opposition to the flow of current in a dc circuit. The unit is the ohm, which is defined as the resistance that will give a one-ampere current flow if a one-volt potential difference is applied in a

circuit. Resistivity is the reciprocal of conductivity; its unit is the ohm/cm.

**Resolution:** The smallest change in input which produces a detectable change in output. This is the smallest increment of change that can be detected by a measurement system. Resolution can be expressed in bits, in proportions, in percent of actual reading or in percent of full scale. For example, a 12-bit system has a resolution of one part in 4,096 or 0.0244% of full scale.

**Resonance:** A condition of oscillation caused when a small amplitude of periodic input has a frequency approaching one of the natural frequencies of the driven system.

**Response time:** An output expressed as a function of time, resulting from the application of a specified input under specified operating conditions.

## S

**Sampling period:** The time interval between observations.

**Scale factor:** The factor by which the number of scale divisions indicated or recorded by an instrument must be multiplied to compute the value of a measured variable.

**Sensing element:** The element that is directly responsive to the value of a measured variable.

**Sensitivity:** The minimum change in a physical variable to which an instrument can respond; the ratio of the change in output magnitude to the change of the input which causes it after the steady-state has been reached.

**Sensor:** An element or device that detects a variable by receiving information in the form of one quantity and converting it to information in the form of that or another quantity.

**Setpoint:** A variable, expressed in the same units as the measurement, which sets either the desired target for a controller, or the condition at which alarms or safety interlocks are to be energized.

**Settling time:** The time required after a stimulus for the output to center and remain within a specified narrow band centered on its steady-state value.

**Signal:** A variable that carries information about another variable that it represents.

**Signal-to-noise ratio:** Ratio of signal amplitude to noise amplitude. The ratio of overall rms signal level to rms noise level, expressed in dB. For sinusoidal signals, amplitude may be peak or rms.

**Span:** The algebraic difference between the upper and lower range values expressed in the same units as the range.

**Span shift:** Any change in slope of the input-output curve.

**Stability:** The ability of an instrument or sensor to maintain a consistent output when a constant input is applied.

**Steady-state:** A characteristic of a condition, such as value, rate, periodicity, or amplitude, exhibiting only negligible change over an arbitrary, long period of time.

**Stiffness:** The ratio of change of force (or torque) to the resulting change in deflection of a spring-like element, the opposite of compliance.

**Strain:** The ratio of the change in length to the initial unstressed reference length of an element under stress.

**Subsidence:** The progressive reduction or suppression of oscillation in a device or system.

**Suppressed range:** A range in which the zero value of a measured variable is greater than the lower-range value (LRV). The terms "elevated zero," "suppression" or "suppressed span" are also used to express the condition when the zero of the measured variable is greater than the LRV.

**Suppressed span:** The span in which the zero of the measured variable is greater than the LRV.

**Suppressed zero:** The range in which the zero value of a measured variable is less than the lower range value. The terms "elevation," "elevated range" and "elevated span" are frequently used to express the condition in which the zero of the measured variable is less than the lower range value.

**Suppression ratio:** The ration of the lower-range value to the span. If range is 20-100 and, therefore, span is 80 and LRV is 20, the suppression ratio is  $20/80 = 0.25$  or 25%.

**Synchronous:** An event or action that is synchronized to a reference clock.

**System noise:** Measure of the amount of noise seen by an analog circuit or an ADC when the analog inputs are grounded.

**T**

**Temperature coefficient:** The amount of drift, in percent of full scale output, that might result from a 1°C change in ambient temperature.

**Thermal shock:** An abrupt temperature change applied to a device.

**Time constant:** The value "T" in an exponential term  $A(1-t/T)$ . For the output of a first-order system forced by a step or an impulse, T is the time required to complete 63.2% of the total rise or decay. For higher order systems, there is a time constant for each of the first-order components of the process.

**Transducer:** An element or device that receives information in the form of one quantity and converts it to information

in the same or another quantity or form. Primary elements and transmitters are also referred to as transducers.

**Transfer function:** Mathematical, graphical, or tabular statement of the influence which a system or element has on a signal or action compared at input and at output terminals.

**Transient:** The behavior of a variable during transition between two steady-states.

**Transmitter:** A transducer which responds to a measured variable by means of a sensing element, and converts it to a standardized transmission signal which is a function only of the values of the measured variable.

**U**

**Upper range limit (URL):** The highest value of a measured variable that a device can be adjusted to measure. (This value corresponds to the top of the range.)

**Upper range value (URV):** The highest value of a measured variable that a device is adjusted to measure. (This value corresponds to the top of the span.)

**V**

**Vapor pressure:** The pressure exerted by a vapor which is in equilibrium with its own liquid.

**Variable:** Any condition that is measured, controlled (directly or indirectly) or manipulated.

**Velocity limit:** A limit on the rate of change which a particular variable may not exceed.

**Vibration:** The periodic motion or oscillation of an element, device, or system.

**Volt (V):** The electrical potential difference between two points in a circuit. One volt is the potential needed to move one coulomb of charge between two points while using one joule of energy.

**W**

**Warm-up period:** The time required after energizing a device before its rated performance characteristics start to apply.

**Z**

**Zero offset:** The non-zero output of an instrument, expressed in units of measure, under conditions of true zero.

**Zero suppression:** For a suppressed-zero range, the amount by which a measured variable's zero is less than the lower-range value; can be expressed as a percentage of either the measured variable or of the span.

**Zone, neutral:** A predetermined range of input values that do not result in a change in the previously existing output value.



### Notice of Intellectual Property Rights

The OMEGA® Handbook Series is based upon original intellectual property rights that were created and developed by OMEGA. These rights are protected under applicable copyright, trade dress, patent and trademark laws. The distinctive, composite appearance of these Handbooks is uniquely identified with OMEGA, including graphics, product identifying pings, paging/section highlights, and layout style. The front, back and inside front cover arrangement is the subject of a U. S. Patent Pending.

**omega.com**®

Ω OMEGA®